

Vantail épaisseur 40 mm
Références TX1 - TX2 - TX4 - TX6

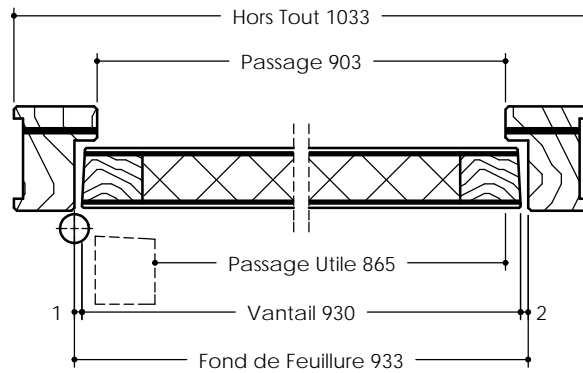

Vantail épaisseur 50 mm
Références TX2 1/2 - TX2 1/2L - TX4 1/2 - TX4 1/2L - TX6 1/2 - TX6 1/2L

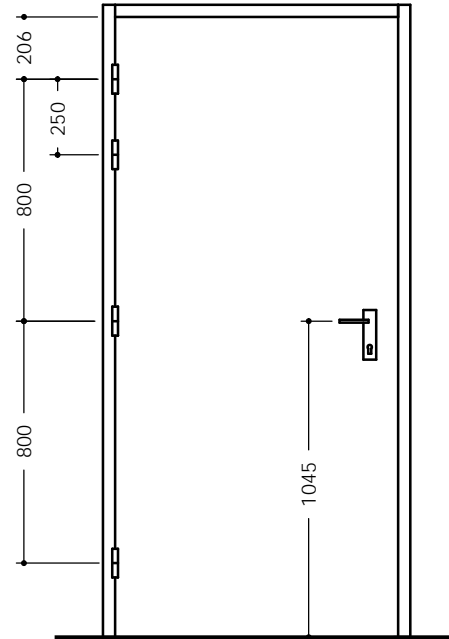
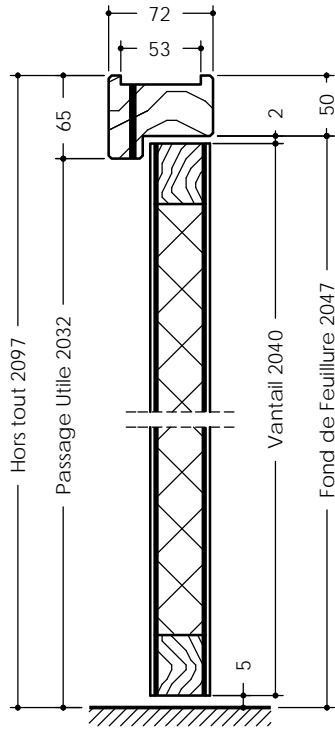
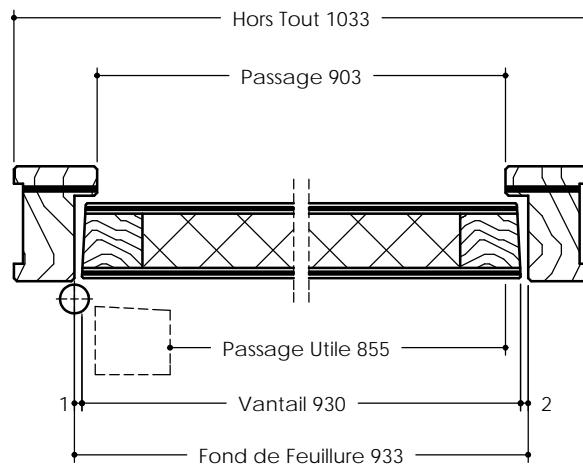
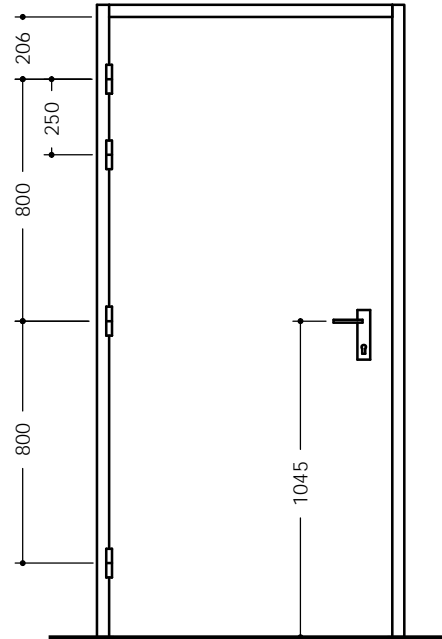
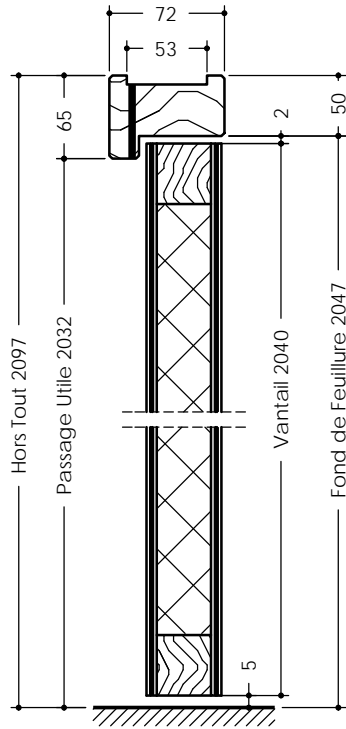

Vantail épaisseur 40 mm
Références TX1 33 - TX2 35 - TX4 39 - TX6 41

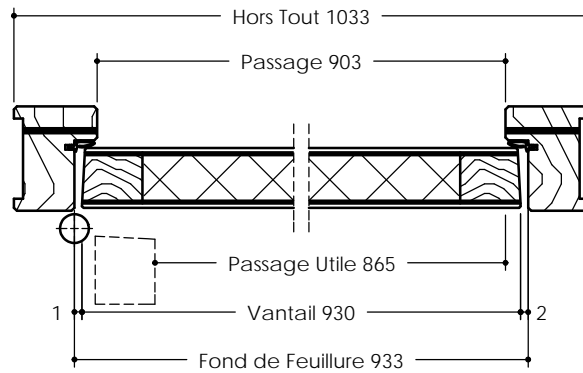
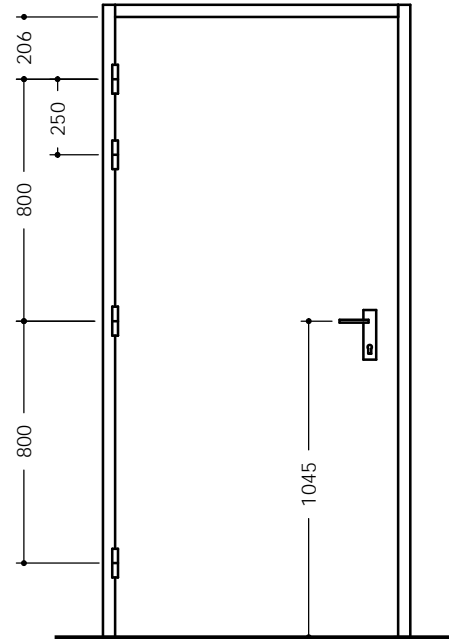
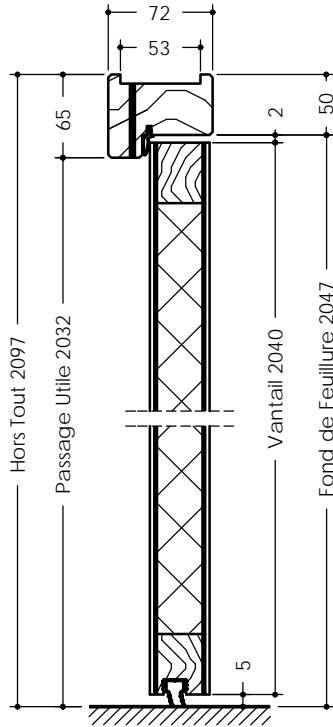

Vantail épaisseur 50 mm

Références TX2 1/2 35 - TX2 1/2L 35 - TX4 1/2 39 - TX4 1/2L 39 - TX6 1/2 41 - TX6 1/2L 41

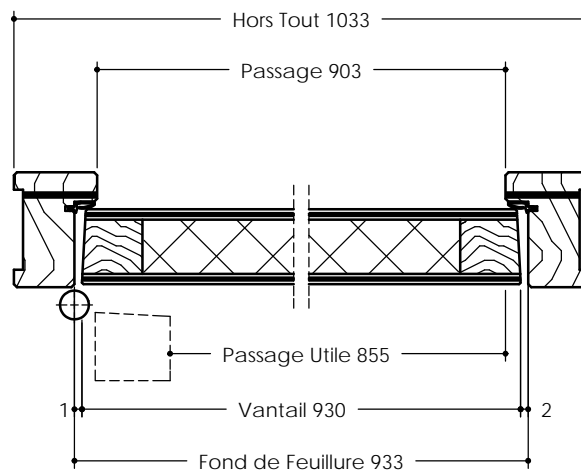
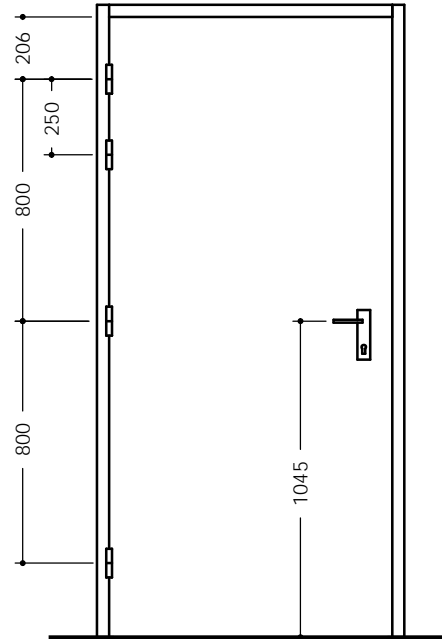
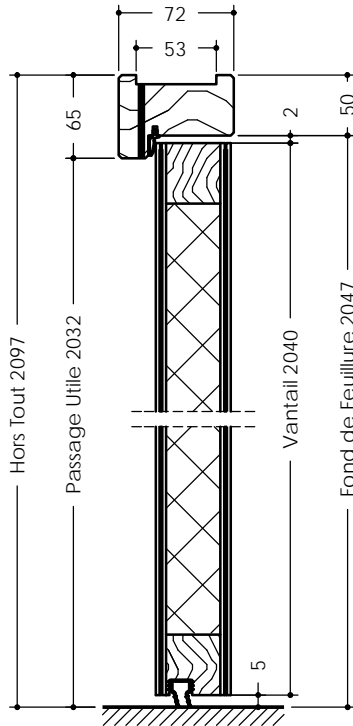

Vantail épaisseur 40 mm
Références TX1 ET - TX2 ET - TX4 ET - TX6 ET

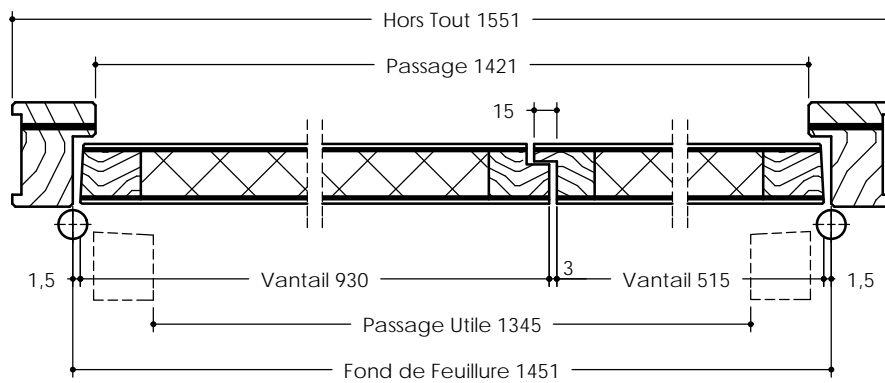
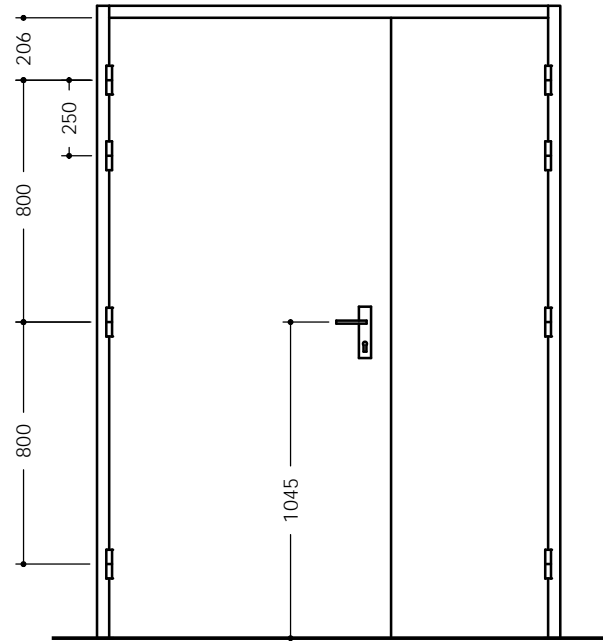
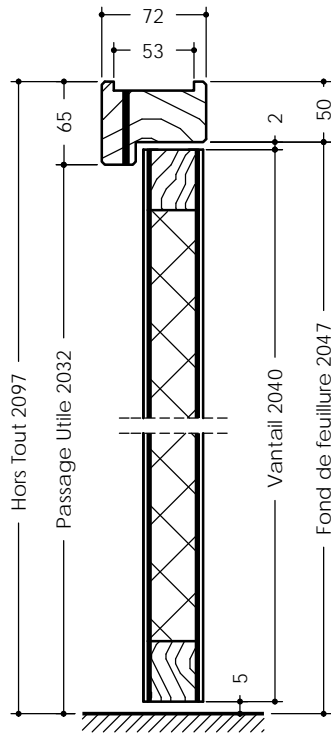

Vantail épaisseur 50 mm
Références TX2 1/2 ET - TX4 1/2 ET - TX6 1/2 ET

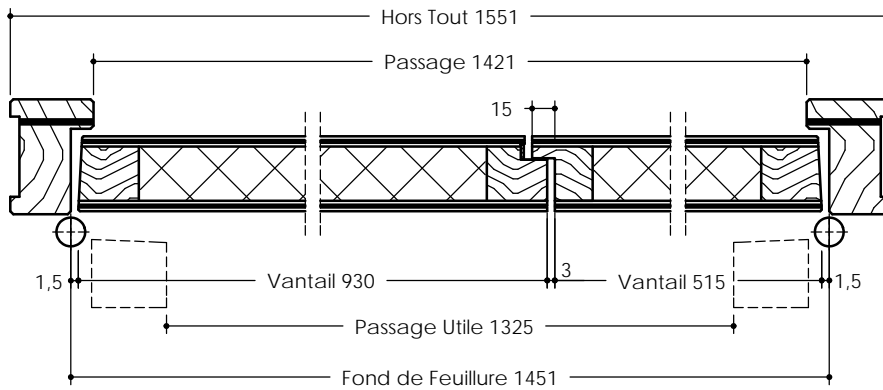
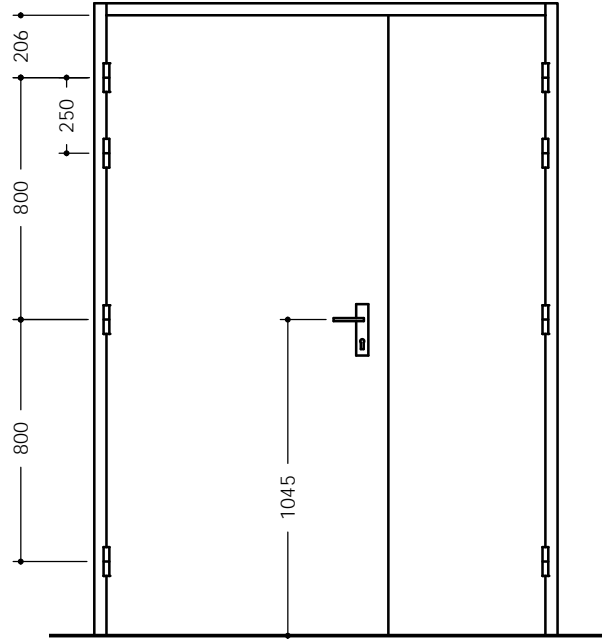
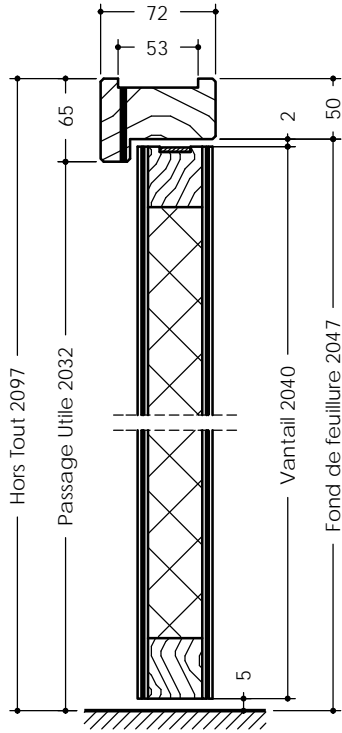

Vantail épaisseur 40 mm
Références TX1 33 ET - TX2 34 ET - TX4 39 ET - TX6 39 ET

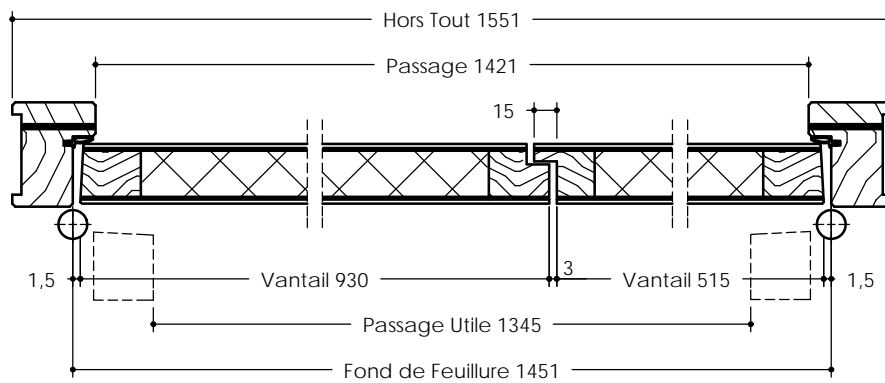
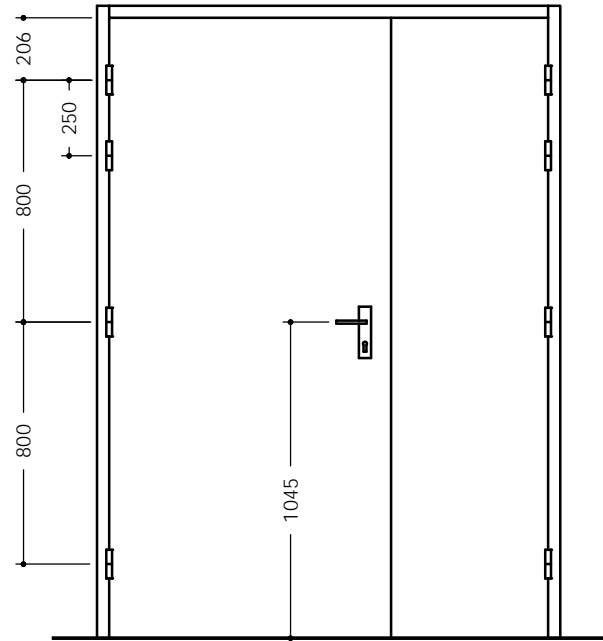
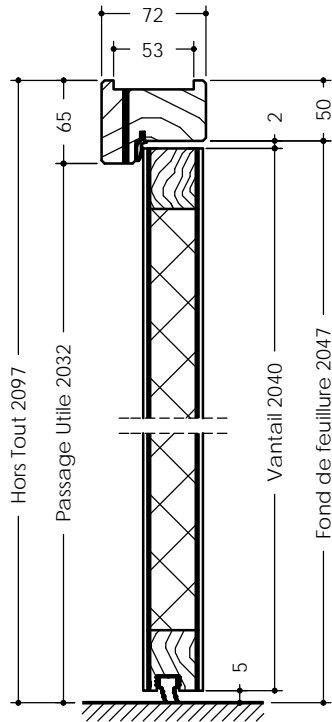

Vantail épaisseur 50 mm
Références TX2 1/2 34 ET - TX4 1/2 39 ET - TX6 1/2 39 ET

