

EXTERNAL JOINERY TECHNICAL SPECIFICATION GUIDE

MARCH 2017





Sliding Sash
All Bar window

CHOOSE THE **BEAUTY** AND **PERFORMANCE** OF **TIMBER**

Choosing the right windows and doors can make a huge difference to the style, appearance and thermal performance of any property. That is why JELD-WEN invests heavily in research and product development to meet legislative performance criteria, as well as aesthetic design to meet the needs of architects, specifiers, contractors and consumers.

JELD-WEN windows and doors are specified for many high profile developments, including zero carbon projects. Timber is one of the few fully sustainable building products and can reduce energy consumption more effectively than most man-made materials.

JELD-WEN aims to source all its timber according to recognised chain of custody schemes and all exterior joinery products shown in this brochure are Forest Stewardship Council® (FSC®) certified as standard.

Proud to be UK based

Like you, we believe that UK manufacturing is unparalleled in terms of quality and craftsmanship. So wherever you see this logo, you can be confident that a product has been manufactured or assembled right here in the UK.

Supporting you

You can download accurate CAD drawings of our products from the 'Professionals' section of our website or request a CAD disc by emailing us at marketinguk@jeldwen.com



We also offer free RIBA accredited CPD courses that will explain windows and doorsets in more detail, and will add points to your core curriculum studies. We also run a free CPD course on timber stairs. Visit the website for more information and to complete your enquiry form.

BSI Kitemark

Our timber window, patio and exterior doorset ranges are certified under the BSI Kitemark certification to ensure quality, performance and safety standards.





Stormsure Oak Casement,
Horizontal Bar windows

CONTENTS

Our Range	4
Behind Our Products	6
Specifying External Joinery	7
Building Regulations	8
Legislation	10
Thermal Performance	11
Glazing Specification	12
Timber Specification	15
Measuring and Tolerances	16
Installation and Handling	18
Cavity Closers	22

WINDOWS

Window Specification Comparison Guide	24
Glazing Windows	26
Window Range Thermal Transmittance	28
Window Range Acoustic Ratings	29
SPECIFICATION, SECTION DETAILS, ACOUSTICS, PURGE VENTILATION & DAYLIGHT AREAS:	
Regal Box Sash	30
Elegance Flush Casement	34
Stormsure Energy+ High Performance Casement	42
Stormsure Standard Casement	50
Sliding Sash	66
Bay Windows	76

EXTERIOR DOORSETS

Exterior Doorset Specification Comparison Guide	80
Specifying Considerations Exterior Doorsets	82
Exterior Doorset Thermal Transmittance	84
SPECIFICATION & SECTION DETAILS:	
INSULUX Timber Composite Doorsets	86
Castle Composite Doorsets	92
Castle Composite Fire Doorsets	98
DreamVu™ Softwood Single Doorsets	102
Farndale Softwood Single Doorsets	106

PATIO DOORSETS

Patio Doorset Specification Comparison Guide	112
Specifying Considerations Patios	114
Patio Range Thermal Transmittance	115
SPECIFICATION & SECTION DETAILS:	
Oak Canberra Folding Sliding	116
Darwin Hardwood Folding Sliding	120
Oak Canberra French	124
Darwin Hardwood French	128
DreamVu™ Softwood French	132
Farndale Softwood French	136
Fenton Sliding	142

EXTERIOR DOOR FRAMES

Specifying Considerations Door Frames	146
Assembled Door Frames	147
Front Entrance Assembled Door Frames	149
Fire Door Assembled Door Frames	150
Flat Pack Door Frames	151

FINISHING & GLAZING

Finishing Exterior Joinery	152
Choosing Your Hardware	154
Commitments and Guarantees	158
General Maintenance Guidelines	159
Case Studies	160

OUR RANGE

We offer standard and made to measure windows, exterior doorsets and patio doorsets and can offer a fully customised service for your project. Contact us to discuss your requirements.



Page 30

REGAL BOX SASH

Our high specification Regal Box Sash timber window range has a true weights and pulleys system that provides a direct replacement for an original box sash window.



Page 34

ELEGANCE FLUSH CASEMENT

Our Elegance window range is perfect for conservation projects and adds a contemporary twist and modern energy efficient performance to a traditional building.



Page 42

STORMSURE ENERGY+ HIGH PERFORMANCE CASEMENT

Our Stormsure Energy+ casement window range comes with an A+ rating and U values down to $0.8 \text{ W/m}^2\text{K}$ for the best in energy performance.

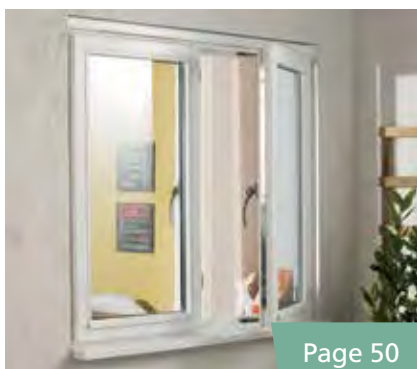

Page 50

STORMSURE STANDARD CASEMENT

Our most popular timber windows are available in a range of designs and a choice of softwood and oak timber.



Page 66

SLIDING SASH

Our softwood timber Sliding Sash windows combine an authentic period feel with modern engineering to match local architectural style and planning requirements.



Page 76

BAY WINDOWS

We offer bay window solutions to match our casement, Elegance and Sliding Sash ranges, with a choice of square, splay or oriel bay window options to suit all project requirements.



Page 86

INSULUX TIMBER COMPOSITE DOORSETS

Our new range of timber composite doorsets offers an advanced solution for added security and warmth with U values down to $1.2 \text{ W/m}^2\text{K}$ for the whole doorset. Available in a range of 8 panel and glazed designs.



Page 92

CASTLE COMPOSITE DOORSETS

A high quality, energy efficient GRP composite doorset range available in a wide choice of traditional and contemporary door designs, and supplied complete with frame and ironmongery fitted. FD30 fire door options available.



Page 102

DREAMVU™ SINGLE

This softwood high performance single doorset offers ultimate weather resistance and security. Standard and made to measure sizes available with a choice of side light options.

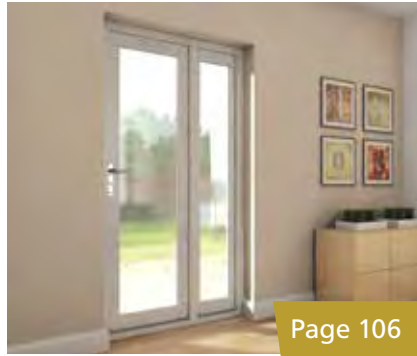

Page 106

FARNDALE SINGLE

The softwood Farndale single doorset features an attractive, contemporary design, with slim timber sections to maximise the glazed area, and is available in a large range of standard and made to measure sizes with bar design options.



Page 116

CANBERRA FOLDING SLIDING

Our made to measure Canberra folding patios are our premium, solid oak door range providing excellent strength and stability.



Page 120

DARWIN FOLDING SLIDING

The Darwin hardwood patio doorset range combines style and strength, with it's 54mm thick doors offering a robust doorset which can be painted or stained in a range of popular colours to match other exterior décor.



Page 124

CANBERRA FRENCH

Providing a suited option to the Canberra folding sliding patios, this is our premium oak French doorset. Available with optional side lights.



Page 128

DARWIN FRENCH

Our Darwin French patio doorset is solid hardwood product that can be painted or stained to match the JELD-WEN window range. Optional side lights are available.



Page 132

DREAMVU™ FRENCH

Our highest performance doorsets with U values down to $1.0 \text{ W/m}^2\text{K}$, provides the best thermal performance and security in the range.

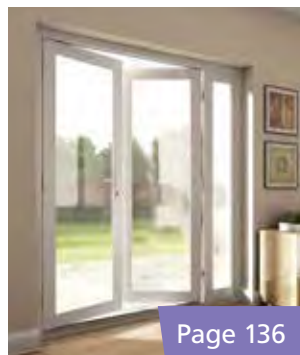

Page 136

FARNDALE FRENCH

The softwood Farndale French doorset offers a large range of standard and made to measure sizes with bar designs and side light options to choose from.



Page 142

FENTON SLIDING

This attractive slimline softwood timber sliding patio doorset comes in a variety of sizes to help you open up tight or large spaces.

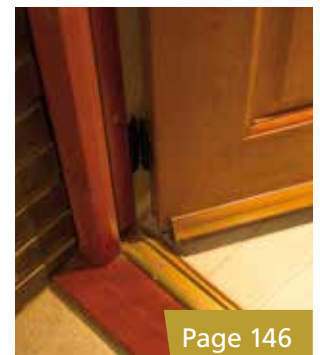

Page 146

EXTERNAL DOOR FRAMES

Assembled oak veneer sliding door frames are available to complement oak Stormsure windows and oak external doors.

BEHIND OUR PRODUCTS

JELD-WEN recognises the importance of acting responsibly and strives to be at the forefront of innovation in order to drive the highest standards within the industry. We work closely with third party industry bodies to achieve this, and to ensure all our products are tested to meet current legislation and standards across the UK.

Quality standards

We understand how important quality is to our customers and therefore continually develop our products and services to achieve the high standards that are expected.

We are formally assessed under quality and environmental practices and all our factories are ISO9001: 2008 and ISO14001: 2004 certified.

Our products undergo rigorous testing to ensure they can perform to the highest standards when installed.

We also carry a number of third party accreditations and affiliations including:



We actively support the development and standards of timber windows and our membership ensures we are performing on quality, performance and sustainability. WWA life cycle assessments confirm that JELD-WEN windows will provide a minimum service life of 60 years.



The TWA Scheme, set up by the British Woodworking Federation, provides one of the most rigorous and best supported of the UK certification schemes for wood windows.



Our timber window, patios and exterior doorset ranges are certified under the BSI Kitemark certification to ensure quality, performance and safety standards.



Our Stormsure Casement and Sliding Sash window ranges are energy certified by BFRC to offer an alternative method of assessing thermal performance.



JELD-WEN factory glazed windows and external doorsets are CE marked as directed under European law.



Approved Document Q of the Building Regulations for England now details the requirement for security in new dwellings and material change of use. PAS 24 is the product test standard required to meet this regulation.

We offer PAS 24 tested options on a selection of our products where you see this symbol.



Secured by Design (SBD) is the official UK Police flagship initiative supporting the principles of 'designing out crime'. Products have been tested and approved under the scheme wherever you see the logo.

SYMBOLS

We have a range of symbols that will help you identify and choose what is right for you.



Forest Stewardship Council® certification ensures responsible sourcing of timber. This is standard certification for all our products in this catalogue except door frames.

Look for FSC certified products.



Manufactured or assembled in the UK.



All our windows and some of our patio doorsets are available made to measure.

Energy Ratings

Window Energy Ratings (WERs) are available on all our window ranges and are determined in compliance with BFRC Domestic Energy Rating rules. Please specify what rating you require when ordering to get the correct specification.



Window handing key

When viewed from outside



Left hand hung



Right hand hung



Top hung

SPECIFYING EXTERNAL JOINERY

There are a number of things to consider when specifying external joinery:

- **Design** – The style and finish of the products need to reflect the building design, any planning guidance and the aspirations of the client. Timber windows and doors offer subtle design features that create a traditional or contemporary quality feel, helping new fittings blend into an old home or adding a touch of luxury to a modern building.
- **Design details** – Glazing requirements, locks, enhanced security e.g. PAS 24 etc.
- **Planning** – What are the local project requirements? For example Grade 1 listed, Conservation etc
- **Performance** – Windows and doors will contribute to the overall performance of the building. You will therefore need to consider the following performance ratings in addition to Building Regulation requirements:
 - Exposure category
 - Solar gain
 - Air permeability requirement
 - Acoustic performance
 - Lifetime Homes
 - Thermal performance of the building and individual product elements
 - Code for Sustainable Homes
 - Environment - maritime etc
- **Building Regulations** – Which Building Regulations apply and what are the standards? The Building Regulations for the replacement of windows and doors vary to new build, and there may be differences between England, Scotland, Northern Ireland and Wales who each have their own standards. See page 8 for further information.
- **Budget** – A key requirement but don't forget to consider whole life cycle costing as timber is expected to last almost twice as long as PVC-u frames.
- **Responsible** – As we move towards a carbon neutral future, material consideration has to be at the forefront of design consideration for buildings. Timber is the only truly sustainable building material, emitting less CO₂ in the manufacturing process than its manmade rivals. Unlike PVC-u, it is carbon neutral, fully recyclable and biodegradable. All our external joinery is also FSC certified (except our doorframes) which means we have sourced wood from Chain of Custody forests that have been independently verified against worldwide standards.

Timber frames can save over **1.5 tonnes CO₂e** per house

In a recent report for the WWA by Heriot Watt University, one of the most important findings is that all timber-based window frame materials have a negative GWP (Global Warming Potential) over a 60-year service life – that is to say they reduce the CO₂e in the atmosphere, rather than adding to it.

Using a timber window frame instead of PVC-u saves roughly 160kgs CO₂e over 60 years in average conditions. In a house with 10 windows, that's over 1.5 tonnes CO₂e. The study also finds that timber frames made to WWA specifications can be expected to last around 60 years, twice as long as comparable PVC-u frames. All JELD-WEN windows meet with the WWA specification.

Report: Life Cycle Assessment of timber, modified timber and aluminium-clad timber windows.

May 2013, by Dr Gillian Menzies, Institute for Building and Urban Design, Heriot Watt University, Edinburgh.



BUILDING REGULATIONS

Building regulations drive product design of JELD-WEN products to ensure they comply at all times. This information provides guidance on the relevant regulations you need to consider when specifying our external joinery products.

Building Regulations, England and Wales. Additional requirements under Scottish Building Regulations

How JELD-WEN can help you comply:

JELD-WEN quoted *U* Values in this catalogue cover most products and are provided to assist correct selection. Many JELD-WEN products are also available with alternative, both lower (better) and higher, *U* Values to meet particular requirements.

There are a total of 14 parts to Building Regulations. You can view the latest Approved Documents on the building control website.

As a guide, you also need to consider the following when selecting our products:

WINDOWS

Approved Document B - Fire safety

In first floor habitable rooms, for example bedrooms, windows must be wide enough to provide a means of escape. In some situations there may be a requirement for fire resisting windows.

Approved Document E - Resistance to passage of sound

Removing a ventilator in the head of a window and changing the glass spec will significantly improve acoustic performance. Generally an acoustic engineer report would be required to ensure complete compliance.

Approved Document F Ventilation ("System 1" background ventilation)

Total new build requirements were increased by typically 30% but the minimum per habitable room of 5000mm² Equivalent Area (EA) was unchanged (typically 8000mm² actual area). Other ventilation systems ie System 2 Passive Stack Ventilation, System 3 Continuous Mechanical Extract (MEV) and System 4 Continuous Mechanical Supply & Extract with Heat Recovery (MVHR) will be determined by the Building Designer. Requirements for window ventilation will differ from System 1.

JELD-WEN Windows are supplied standard with 2500mm² EA ventilation for windows below 900mm wide and 5000mm² EA 900mm wide and wider. Additional ventilators on windows over 1700mm wide and "No ventilator" options are available to order.

Replacement windows require ventilation only if the originals were vented. However good practice recommends ventilation in all cases.

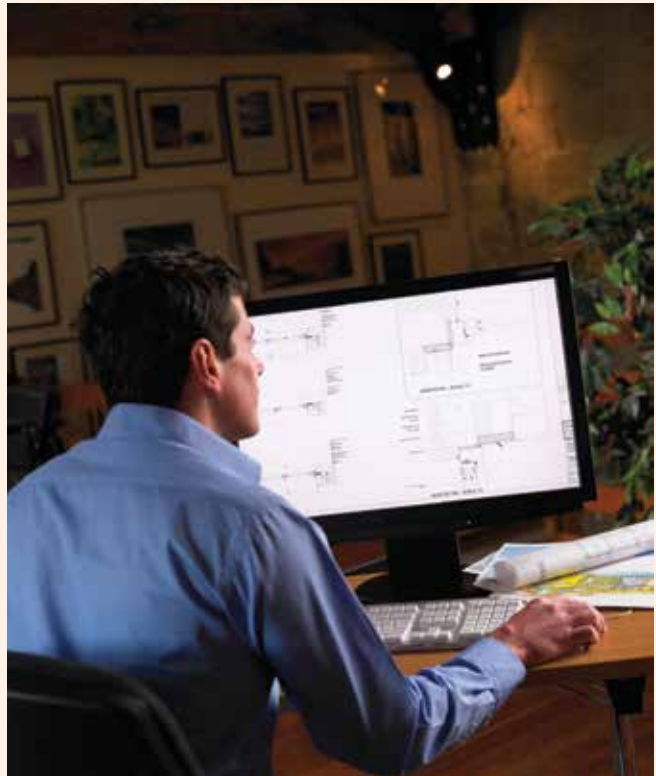

Approved Document K - Protection from falling, collision and impact

Windows should not open onto walkways in or around buildings and containment is required by the use of guarding/glazing in some situations, particularly where the window sill is below 800mm from floor level.

Glass must be toughened or laminated in certain locations and if it does break then it must do so without causing injury. Reversible windows must also be fitted with restrictors. Please let us know if you require restrictors.

Approved Document L Ventilation "Conservation of Fuel & Power"

New Build Windows performance is determined by the Building Designer but the *U* Value (the thermal performance) of windows and doorsets is typically in the region of 1.4 to 1.6 W/m²K – Higher levels of building airtightness can also be designed in to improve whole building performance.

Replacement windows require a max *U* Value of 1.6 or a Window Energy Rating (WER) of "C" or better.

Centre Pane (glass only) *U* Value is no longer accepted as demonstrating compliance, (except in certain historic buildings renovation).

Approved Document Q - Security - New Dwellings and material change of use

For all projects submitted to planning from 1st October 2015, any window within the scope of Approved Document Q needs to meet the requirements of PAS 24:2014.

All windows that provide an 'easily accessible' entrance to the dwelling as defined in Approved Document Q, must comply with reasonable standards to resist physical attack by a casual or opportunist burglar by being both sufficiently robust and fitted with appropriate hardware.

If your project requires this compliance you must specify on all your enquiries and orders.

DOORS & DOORSETS

Approved Document B - Fire Safety

Fire doors save lives! They protect escape routes and contain a fire to prevent it spreading throughout a building allowing occupants time to escape. JELD-WEN offer both FD30 and FD60 certified doors, which provide either a 30 or 60 minute fire resistance.

Approved Document E - Resistance to passage of sound

Buildings must provide reasonable resistance to sound. Flat entrance doors should have good perimeter seals including the threshold where practical, and achieve 29dB_{Rw} sound reduction or better. In most situations, doors must also be fire rated.

Approved Document F Ventilation ("System 1" background ventilation)

JELD-WEN external and door frames are available with ventilators as an option to enable total ventilation requirements to be met.

Approved Document K - Protection from falling collision and impact

Provision should be made to ensure a clear view of the space either side of a door where appropriate.

Toughened glass in doors is a requirement except for small panes of glass, in this instance the glass usually has to be at least 6mm thick.

Approved Document L Ventilation "Conservation of Fuel & Power"

New Build Windows & Doorsets performance is determined by the Building Designer but the *U* Value (the thermal performance) of windows and doorsets is typically in the region of 1.4 to 1.6 W/m²K – Higher levels of building airtightness can also be designed in to improve whole building performance.

Replacement doorsets with greater than 60% glass area must have max *U* Value of 1.8.

Replacement doors ie doors fitted into original installed frames (unchanged) are outside the scope of the changes but in any event should not be worse than the doors being replaced.

Approved Document M - Access and facilities for disabled people

Doors must be wide enough to gain access into buildings and allow for movement within buildings. The minimum width will vary but usually 2'9" (838mm), is fine externally and we offer a range of internal sizes at 2'9" (838mm), 2'10" (864mm) and 3'0" (914mm) for compliance. In buildings other than dwellings, vision panels are important as is the positioning of these. Please advise your clear opening requirements.

Approved Document Q - Security - New Dwellings and material change of use

For all projects submitted to planning from 1st October 2015, any doorset within the scope of Approved Document Q needs to meet the requirements of PAS 24:2014.

All doorsets that provide an 'easily accessible' entrance to the dwelling as defined in Approved Document Q, must comply with reasonable standards to resist physical attack by a casual or opportunist burglar by being both sufficiently robust and fitted with appropriate hardware. In addition, there will be requirements for door hardware and accessories such as chains and letter plate openings.

If your project requires this compliance you must specify on all your enquiries and orders.

STAIRS

Approved Document B - Fire safety

Stairs in some situations have to be fire resistant. We provide fire resisting stairs certified by the LPCB (Loss Prevention Certificate Board) and we are the first volume stair manufacturer to be certified by the LPCB.

Approved Document E - Resistance to passage of sound

Stairs are subject to sound insulation requirements, we offer a rubber matting which is applied to the underside of the staircase.

Approved Document K - Protection from falling collision and impact

Approved Document K determines the height and depth of the steps, this will vary depending upon the type of building and will also impact on the pitch and overall length of a staircase.

Approved Document M - Access and facilities for disabled people

The steps of a staircase have to be wider and lower and must not have any trip hazards such as nosing. There must also be a continuous handrail on each side.

Scottish Building Regulations

Technical Handbooks published by the Scottish Government differ from England & Wales requirements in certain aspects as summarised below:

Thermal performance: New Build specify that the maximum "area weighted average" *U* Value must not exceed 1.6, with no individual element exceeding 3.3 W/m²K. For replacements the requirements allow an "area weighted average" *U* Value of 1.6 with no individual element exceeding 3.3 "C" rated WER windows are allowed (as England & Wales).

Ventilation: The Scottish requirements refer to actual (geometrical) area only with 8000mm² being the requirement for rooms in apartments, 4000mm² in other rooms. Increased areas of ventilation are required for buildings designed with greater levels of airtightness.

Security: This is an additional requirement applicable in Scotland. There are several alternative methods of demonstrating compliance, one being the use of "Secured by Design" approved products i.e. windows and doorsets tested to PAS 24, all available from JELD-WEN UK Ltd.

The responsibility for correct specification remains with the Building designer (for new build) or the installer (for replacement products). If in any doubt customers should always seek the advice of their Local Authority Building Control Department. There may be other regional differences in requirements not included in the above (Northern Ireland, Channel Islands, etc.). JELD-WEN UK Ltd does not accept any liability for incorrectly specified product and resulting non-compliance with regulations.

***U* Value declarations**, as stated in Declaration of Performance (DOP) as required by Construction Products Regulations (CE Marking).

U Values stated are determined by reference to BR 443 or EN14351-1 standard window and doorset dimensions. Window type is single frame and full opening sash.

U Values of windows and doorsets are less than or equal to DOP values.

BUILDING REGULATIONS

Other regulatory details:

BS 8300:2009 + A1:2010

Design of buildings and their approaches to meet the needs of disabled people – Code of practice.

BS 6262-4:2005

Code of Practice for Glazing for Buildings Part 4. Safety related to human impact.

Further details of these standards can be found at the BSI website: www.bsi-global.com

PAS 24

Approved Document Q of the Building Regulations for England now details the requirement for security in new dwellings and material change of use. PAS 24 is the product test standard required to meet this regulation. Where indicated our products can be supplied with PAS 24 specification.

A selection of our products are also available with Secured by Design specification. Further details of the Secured by Design scheme can be found at: www.securedbydesign.com



Conservation of Fuel and Power	
England	AD L1A AND AD L1B
Scotland	Section 6
Northern Ireland	Technical booklet F
Wales	AD L1A AND AD L1B

Means of escape from fire	
England	Approved Document B
Scotland	Section 2
Northern Ireland	Technical booklet E
Wales	Approved Document B

Glazing – Safety	
England	Approved Document K
Scotland	Section 4
Northern Ireland	Technical booklet V
Wales	Approved Document N

AD = Approved Document

Please note: Channel Islands and Isle of Man are excluded from the above regulations

Security	
England	Approved Document Q
Scotland	Technical handbook 4

Ventilation	
England	Approved Document F
Scotland	Section 3
Northern Ireland	Technical booklet K
Wales	Approved Document F

Smoke Ventilation	
England	Approved Document B
Scotland	Section 2
Northern Ireland	Technical booklet E
Wales	Approved Document B

Protection from Falling	
England	Approved Document K
Scotland	Section 4
Northern Ireland	Technical booklet H
Wales	Approved Document K

LEGISLATION

Responsibility

JELD-WEN aspires to be the industry leader in environmentally responsible practices and products. We have committed ourselves to more responsible business practices and environmental stewardship. This affects every aspect of our organisation and governs our approach to energy efficiency, air and water emissions and indoor air quality.



At JELD-WEN we have a responsible, renewable timber sourcing policy and are extremely proud to have received FSC® multi-site chain of custody certification dedicated to promoting responsible forest management.

We have also received PEFC multi-site chain of custody certification. If you want FSC® or PEFC products speak to your local branch or a member of our team to discuss your requirements.

All JELD-WEN products meet the EU Timber regulations which aims to prevent the trade in illegal harvesting of timber.

Biocide Regulation

JELD-WEN exterior joinery is treated with an approved wood preservative and protected against wood decaying fungi.

For all UK manufactured timber windows, door frames, DreamVu™, Farndale & Fenton patio products the active ingredients are tebuconazole, propiconazole and cypermethrin.

Preserved wood should not be cut or otherwise reworked as this will expose un-preserved wood. Any surface which is exposed by cutting or drilling must be retreated with an HSE approved cut end preservative. Follow the instructions for safe use on the manufacturers' safety data sheet.



CE Marking

JELD-WEN factory glazed windows and external doorsets have been CE marked as directed under Construction Products Regulations on 1 July 2013.

CE marking is not required for internal doorsets or staircases at this time.

What is the purpose of CE Marking?

It is the "passport" for products allowing them to be sold legally across the whole of the European Single Market. It is European Law, standing above UK legislation. It also provides tighter control of products and their claimed performance, ensuring products do what they should and completed buildings meet their claimed performance.

What has JELD-WEN done to implement CE Marking?

- Placed the CE mark as a label on each product or packaging
- Provided a Declaration of Performance (DoP) for each product available to download from the website in our download centre which is the legal declaration of its performance.

Does a window that is glazed on site need to be CE Marked?

Yes, windows are always glazed and once glazed they require CE Marking. While it is technically possible to buy an unglazed window and separately buy a glass unit, when put together they then require to be CE marked.

JELD-WEN recommends that customers buy fully glazed windows to ensure compliance.

For more information about CE Marking visit our website.

THERMAL PERFORMANCE

With windows and doors responsible for around one fifth of a building's energy loss, the choice of material and specification is more important than ever.

Thermal transmittance values are declared in the form of either a U value or a Window Energy Rating (WER). Both are means of compliance with Building Regulations. WERs are commonly specified for replacement windows, with the rating of the product clearly identifiable. U values are used commonly on new builds with the window and doorset specification driven from SAP calculations by the building designer or architect.

U Values

A windows thermal performance is a windows' whole U value not just the value of the centre pane U value. U values are determined by reference to EN14351-1 and window type is a single frame and fixed sash.

We offer a range of U values depending on the project type to meet new build and other project and regional requirements.

See pages 24, 80 and 112 for U value calculations and comparisons for our window, exterior doorset and patio doorset ranges.

Energy ratings

Offers an alternative method of assessing thermal performance and is currently available across our window range. Independently certified by BRFC they provide:

- a simple method for comparing the overall energy performance of windows;
- measure U value, solar gain and air leakage
- are classified with A+ being the highest, achieved by us on Stormsure Energy+ range
- are consumer friendly as are used on other consumer products

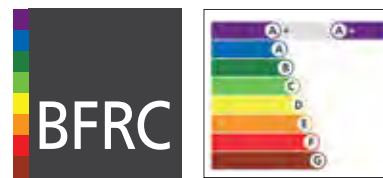



GLAZING SPECIFICATION

Glazing

Glazing is undertaken in controlled factory conditions which provide quality and adherence to correct glazing practices in line with BS 6262 standard. This includes a 5mm clearance between the edge of the glass unit and the rebate to assist with drainage and ventilation commonly referred to as a drained and vented glazing system.

We recommend ordering factory finished glazed windows to ensure windows comply with legislation and are at recommended standards for the best overall performance.

Safety Glazing

We recommend using toughened or laminated glass around low level areas or in areas that need extra safety.

This option takes into account the publication of harmonized European standards for glass products, including the publication of BS EN 12600 for impact testing and classification of flat glass, and the withdrawal of BS 6206:1981 for the classification of "safety glass".

Critical Locations

The following locations may be considered "critical" in terms of safety:

- (a) Between the finished floor level and 1500mm above that level in doors and in side panels which are within 300mm of either edge of the door;
- (b) Between the finished floor level and 800mm above that level in the case of windows not included in (a) above;
- (c) Mirrored doors and panels.

Glazing wholly or partly within a critical location should be one of the following:

- Safety glass is classified in accordance with BS EN 12600 (See Table 1).
- Robust – Annealed glass that does not normally comply with BS EN 12600 can be used in critical locations when the nominal thickness and dimensions are as listed in Table 2 and all four edges are supported.

Table 1

Critical Location	Minor dimension of pane	Minimum Recommended Classification (*)
Doors	> 900mm	2
	≤ 900mm	3
Door side panels	> 900mm	2
	≤ 900mm	2
Fully backed mirror glazing	> 900mm	2
	≤ 900mm	3
Unbacked mirror glazing accessible from one side only	> 900mm	2
	≤ 900mm	3
Low level glazed areas	Irrespective of pane dimension	3
Bathing areas		3
Areas of special risk		3

Table 2

Nominal Thickness (BS 952-1 (12))	Maximum pane size
8mm	1100mm x 1100mm
10mm	2250mm x 2250mm
12mm	4500mm x 4500mm
15mm or thicker	No limits

Sizes in the above table are taken from BS 952-1 (12), for individual product limitations please see relevant product pages.

- Small panes – Ordinary annealed glass, not less than 6mm thick, may be used in small panes up to a maximum width of 250mm and an area not exceeding 0.5m². (Traditional leaded lights and copper lights may use glass 4mm thick.)
- Permanent screen protection – If glazing in a critical location is protected by a suitably designed protective screen system the glass does not need to be safety glass.

Safety glazing locations

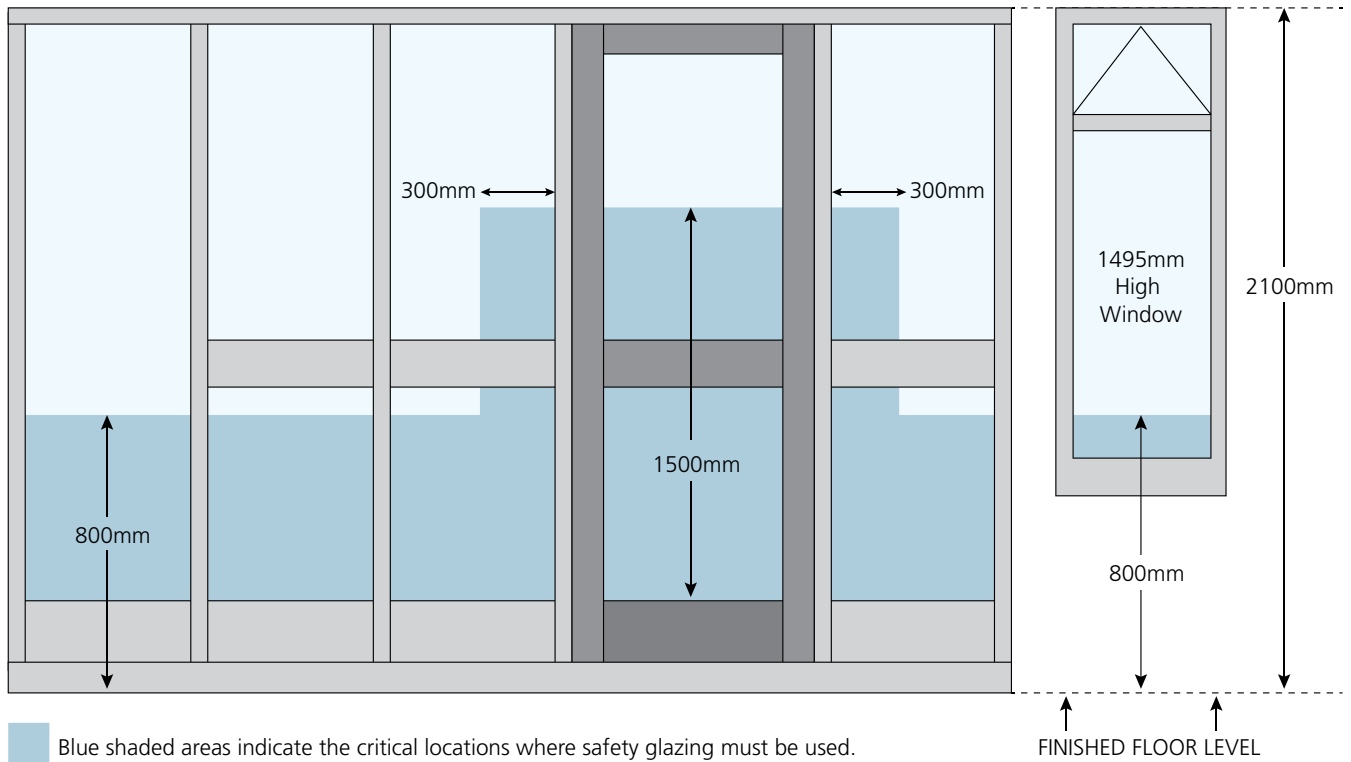

Other glazing considerations

Any glazing forming part of a bath or shower screen, or located adjacent to, or surrounding a bath, swimming pool, or other associated wet area, constitutes a potential danger because of the possibility of a person slipping on a wet surface.

JELD-WEN UK uses toughened and laminated glass units to achieve safety requirements.

Toughened Tempered Safety Glass

All safety glazing and insulating glass units, where applicable, are marked with the appropriate identification to ensure correct, safe installation and permanent traceability.

Laminated Glass (external pane)

Recommended for an enhanced degree of resistance against breakage and entry. Also used internally for critical locations as required. Refer to Approved Document Q.

All double and triple insulated glass units come with either, Argon or Krypton gas filled cavities.

The type will be determined by the overall thermal performance of the specified windows.

Acoustic windows

Demand has increased for higher acoustic performance on windows and doors. JELD-WEN has various specifications of glazing and window designs to meet these requirements. We have included our acoustic data for windows to help you make the right choice.

GLAZING SPECIFICATION

Glazing Definitions

Safety Glass

Glass product conforming to BS EN 572-3, BS EN 572-6, BS EN 12150-1, BS EN ISO 12543-2, EN 14179-1 or BS EN 13024-1 that has a performance classification in accordance with BS EN 12600.

Unbacked mirror glazing

Glazing which has either no backing or only partial backing behind its entire area, or has a backing that does not retain its integrity or is cracked or broken when tested as described in BS 7449:1991, Annex A.

Where glazing is situated in a window where it is likely to be subject to accidental human impact, precautions should be taken to reduce the risk of injuries by:

- selecting glazing of a suitable type, thickness and size, primarily with reference to impact behaviour and safety characteristics as established by testing in accordance with BS EN 12600
- providing mechanical protection to the glazing
- enhancing a person's awareness of the presence of transparent glazing

If glazing does not have permanent screen protection;

- for glazing wholly, or partly, within 300mm from a door and within 1500mm from the floor or in other locations within 800mm of the floor the pane will be toughened or laminated and will conform, when tested, to class B of BS 6206 or class BS EN 12600
- in some circumstances, if the smaller dimension of the pane is 250mm or less and its area is 0.5m² or less then glass with a nominal thickness of 6mm not conforming to class B of BS 6206 may be used.

JELD-WEN UK supply factory glazed windows above 1350mm in height with the low level units as toughened (tempered) safety glass.

GLAZING SUPPLIED BY



JELD-WEN's extensive range of UK manufactured casement windows; patio and exterior doorsets are supplied factory fitted with Pilkington **energiKare™** gas filled units (to EN 1279 Pt3) as standard.

The Pilkington **energiKare™** range utilises 'Low emissivity' coated glass to reflect heat back into a building, greatly improving its thermal efficiency and also maximising the use of freely available heat from the sun. Poorly insulated windows account for up to 20% of the heat loss in an average home.

The combination of JELD-WEN window range performance and design combined with Pilkington **energiKare™** insulating glass units means there is a window range suitable for every project.

The Pilkington **energiKare™** range has high light transmittance and appears virtually the same as clear float glass. In certain circumstances all low emissivity coatings may produce transient visual effects. In oblique lighting the coating may look

European Standards

BS EN 12600:2002 Glass in building – Pendulum test – Impact test method and classification for flat glass

BS EN 12150-1:2015 Glass in building – Thermally toughened soda lime silicate safety glass – Part 1 : Definition and description

BS EN 14449:2005 Glass in building – Laminated glass and laminated safety glass – Evaluation of conformity.

BS 6206:1981 Specification for impact performance requirements for flat safety glass and safety plastics for use in buildings

BS EN 572-3:2012 Glass in building – Basic soda lime silicate glass products – Part 3: Polished wired glass

BS EN 572-6:2012 Glass in building – Basic soda lime silicate glass products – Part 6: Polished wired glass

BS EN ISO 12543-2:2011 Glass in building – Laminated glass and laminated safety glass – Part 1: Laminated safety glass

BS EN 14179-1:2005 Glass in building – Heat soaked thermally toughened soda lime silicate safety glass – Part 1: Definition and description

BS EN 13024-1:2011 Glass in building – Thermally toughened borosilicate safety glass – Part 1: Definition and description

BS EN 14428:2015 Shower enclosures – Functional requirements and test methods

British Standards

BS 952-1:1995 Glass for glazing – Part 1: Classification

BS 7449:1991 Specification for inclusion of glass in the construction of furniture other than tables or trolleys, including cabinets, shelving systems and wall hung or free standing mirrors

BS 644:2012 – Timber windows and doorsets – fully finished factory assembled windows and doorsets of various types and specifications

like a transparent film or produce a haze, i.e. a cloudy look to the surface. When light coloured objects such as net curtains are placed close to the glazing they will look slightly darker.

Using the Pilkington **energiKare™** range of units will help to reduce the amount of internal condensation, normally produced when warm moist air comes into contact with a cold surface, due to its energy efficient performance compared to conventional uncoated or single glazing.

All low-e glass types retain more heat in the home. As a result of the improved thermal efficiency the outer face of glass will be cooler and there may be more occurrences of external condensation than with thermally inefficient glazing. This is a natural phenomenon.

www.pilkington.co.uk/energikare

TIMBER SPECIFICATION

We have a sustainable, renewable timber sourcing policy and have received FSC® and PEFC multi-site chain of custody certifications, both dedicated to promoting responsible forest management. All timber complies with the requirements of BS EN 942 2007. We offer oak, hardwood and softwood timber options across our range which is either finger jointed engineered, knotty or laminated engineered timber.

Due to the construction of engineered timber:

- finger/laminate joints may be visible on the finished product.
- visible grain can vary between individual engineered sections.
- timber is a natural product and will swell or shrink to varying degrees dependent on location etc.

Timber Type

Solid Oak/Hardwood

Our solid oak and hardwood is laminated, which means that rather than using a single piece of oak, we use separate pieces bonded together, providing a stronger dimensional stability.

Finger jointed engineered

Finger jointed engineered timber has all the benefits of being a natural material, except it has all natural defects removed such as knots and splits. The engineering of the component reduces the risk of twisting and warping, allowing the product to operate as designed.

Knotty

Knotty timber is traditionally used in external joinery due to its natural properties and grain pattern to achieve a high quality finish. Knots are visible in this type of timber, which need treatment before finishing as described in our technical manual or fitting instructions.

Laminated engineered

Laminated timber is another form of engineered timber with finger joints. The timber has knots and splits removed from the component and it is laminated with glue under high pressure, producing a stable and strong component.

Engineered

Can be finger jointed, laminated or finger jointed and laminated timber.

Preservative treatment

All timber where required is vacuum pressure treated to prevent rot and fungal attack (see page 10 for Biocide information).



Laminated solid oak/
hardwood

Finger jointed engineered
and laminated softwood

Knotty solid softwood



MEASURING AND TOLERANCES

JELD-WEN recommend the following guidelines are followed when measuring openings prior to ordering your frames:

- Complete the method of any cavity closing before installation of windows.
- Take three measurements horizontally and vertically across the opening of the brickwork. The smallest measurement of width and height should be used as your **brickwork (structural) opening** size.
- Then measure diagonally, corner to corner to determine the squareness of the aperture.
- The sill must overhang the external brickwork by at least 25mm.
- Ensure any internal and external reveal sizes are checked and ensure any opening windows will not be blocked in any way eg by render.

Windows, doorsets and door frame sizes shown are **actual frame size** unless indicated otherwise on the product page. Leave a tolerance to allow the frame to fit (deduction from the brickwork size). This will vary depending on new build or replacement and the method of installation i.e. building in (where a 5mm tolerance may be suitable) to cavity closer, straps and screws.

The deduction is made from the total brickwork width and height not per side. In order to cover most eventualities JELD-WEN recommend a 12mm deduction.

For example

Brickwork (structural) opening 1234mm wide x 1456mm high would have an **actual frame** size of 1222mm wide by 1444mm high.

When making an enquiry or placing an order please state if your dimensions are brick/structural or actual product size.

Co-ordinated brickwork module sizes

Equal divide range	BS644: 2003					
Structural opening (mm)	493	635	920	1205	1775	2344
Window width (mm)	483	625	910	1195	1765	2334

This sizing system refers to all our Stormsure and Sliding Sash window ranges.

Metric modular range	BS644: 2003							
Structural opening (mm)	300	600	900	1200	1500	1800	2100	2400
Frame width (mm)	288	588	888	1188	1488	1788	2088	2388

This applies to our Canberra, Darwin, DreamVu™ and Fenton patios.
Brickwork tolerances vary across ranges resulting in slight differences in frame widths.

Brickwork module widths

2 Brick module	Standard brick 215 x 102.5 x 65, Standard 10mm perps between bricks			
	1 light	2 light	3 light	4 light
Structural opening	460mm	910mm	1360mm	1810mm
Window width	450mm	900mm	1350mm	1800mm

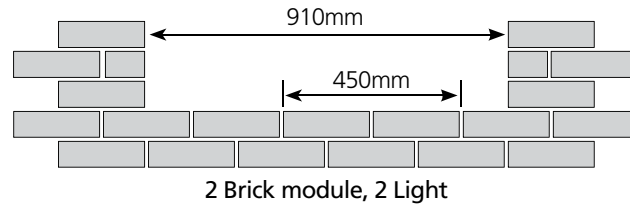
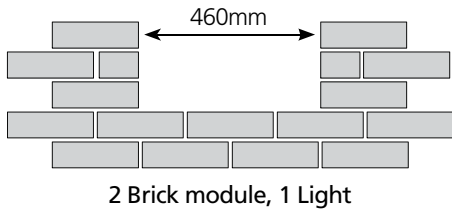

2.5 Brick module	Standard brick 215 x 102.5 x 65, Standard 10mm perps between bricks			
	1 light	2 light	3 light	4 light
Structural opening	572.5mm	1135mm	1697.5mm	2260mm
Window width	562.5mm	1125mm	1687.5mm	2250mm

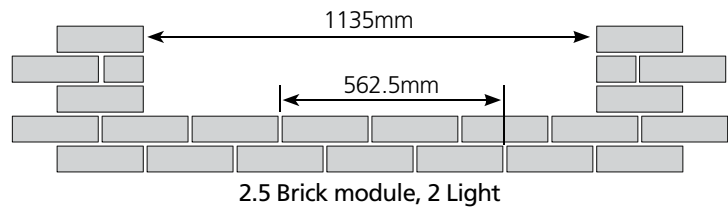
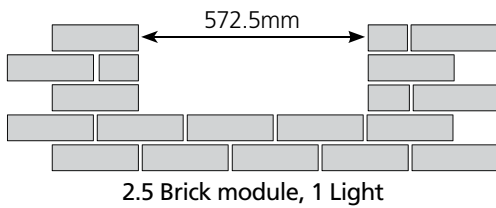

3 Brick module	Standard brick 215 x 102.5 x 65, Standard 10mm perps between bricks			
	1 light	2 light	3 light	4 light
Structural opening	685mm	1360mm	2035mm	2710mm
Window width	675mm	1350mm	2025mm	2700mm

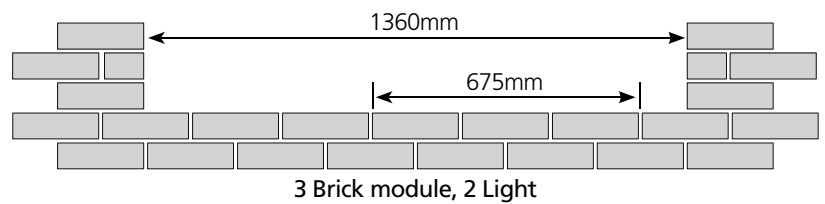
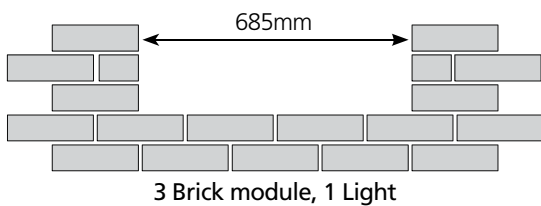

Co-ordinated brickwork module window sizes

These are based on brick course heights (65mm brick + 10mm mortar course).

E.g. 900mm = 12 brick courses

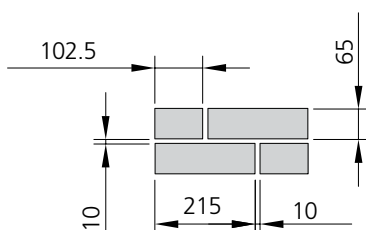

$$2 \text{ Brick Module Increment} = (2 \times 215) + (2 \times 10) = 450\text{mm}$$

$$2.5 \text{ Brick Module Increment} = (2 \times 215) + 102.5 + (3 \times 10) = 562.5\text{mm}$$

$$3 \text{ Brick Module Increment} = (3 \times 215) + (3 \times 10) = 675\text{mm}$$



INSTALLATION AND HANDLING

The way in which products are stored, handled and installed can affect their performance. Good practice avoids damage, maintains quality and saves money.

Windows and doorsets have a range of finishing options available including base coat stained, primed or fully finished in a choice of colours. See page 152 for more information.

Delivery, storage & handling

Follow this check list to avoid injuries and damage:

- ✓ Check your order at the time of delivery to ensure it is correct and that each product including protective packaging isn't damaged.
- ✓ Most products weigh in excess of 15kg so ensure you consider the method of handling to avoid injury or damage to the product. Assess any risks before lifting and get assistance if required. Visit the HSE website for more information www.hse.gov.uk
- ✓ Store your JELD-WEN timber products preferably inside a building in a dry place which is well ventilated and all new plaster is dry. If outside all timber products including fully finished should be stored under a tarpaulin off the ground on level bearers.
- ✓ Do not expose any unfinished products to daylight or extreme temperature or humidity before finishing. Our products are manufactured in moisture controlled environments in line with British Standards. Any additional moisture during storage or installation may cause distortion or swelling.
- ✓ Unglazed products should be stacked flat whilst glazed products should be stored standing upright.
- ✓ Lift windows by the main frame not opening casements or glazing bars and carry vertically to avoid any distortion.
- ✓ Keep protective wrappings on products until finishing and installation where possible.
- ✓ Lift products from each other when stacked, don't drag them, and put spacer packaging between them if they have projecting sills or fitted hardware to avoid damage.

Installation

We recommend fitting all joinery products as soon as possible after the delivery date. For detailed installation information refer to standard BS8213 Pt4 provided by the BSI which gives guidance on good practices necessary for successful surveying and installation of windows and doorsets into new build and replacement situations.

All framed products should be fitted square, true and plumb and should be fitted in accordance with the fitting instructions supplied or project specification, as correct installation is vital to ensuring proper thermal and product performance.

Protect any surfaces from mortar droppings.

All external products are supplied actual frame size and should be fitted into preformed openings with a tolerance around each side.

Tolerance guidance for each product is shown on the specification tables - see pages 24, 80 and 112.

If the product is cut or drilled please ensure the area is preservative treated and decorated before installation.

Window installation

Timber windows can be installed into all types of building designs and JELD-WEN windows are available with a number of options to aid installation.

We recommend using a cavity closer system to help you get the best fit for your JELD-WEN windows see page 26 for further information.

For buildings with vertical tiling or timber cladding, consider the need for site fitted window surrounds.

All window types are available with a selection of sill depths dependant on your design option. Extended sill nosings are not a preferred design option because of their vulnerability to damage and long term erosion. If not adequately maintained this could lead to premature failure of the decoration system.

Glazing

Glazing must be carried out using a proprietary material or glazing system complying with the requirements of BS 8000 Part 7:1990 and must be CE Marked. Glazing rebates and the concealed surfaces of all beads must receive a coat of sealer or two coats of the finishing paint or stain before glazing.

With factory glazed and finished windows, the protection should be left in place unless this interferes with the integrity of the damp proof course membrane (DPC) and seals.

All JELD-WEN factory glazed windows are CE marked.

Forming openings

Windows can be fitted either during construction or into pre-formed openings at a later stage.

A tight fit of adjacent materials should be avoided or there is a danger of distortion in the frame. Side tolerances however should not exceed 10mm on each side.

When not building in, openings can be formed using either proprietary templates or site templates. These templates should produce openings that are 10mm to 20mm larger than the actual window size.

In exposed conditions we recommend using a rebated check reveal (see Figure 1).

Fitting

Figure 1

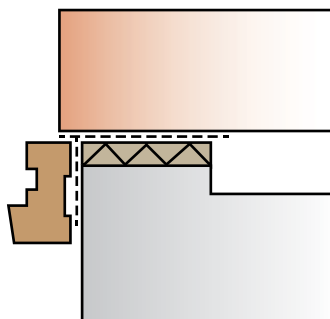

Rebated check reveal

DPCs should be fitted as the construction proceeds. This can be achieved by fixing the DPC to the frame prior to building in, or by fitting it into the structure when making pre-formed openings. In the latter case it is often convenient to use wider DPCs than needed (see Figure 2).

Avoid forming a cold bridge when fitting windows.

Figure 2

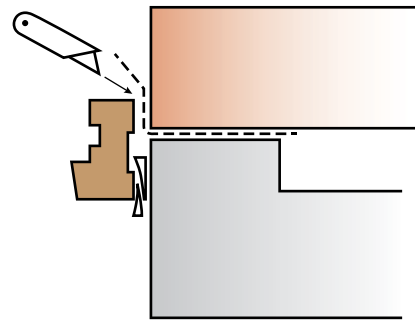

Using wider DPC for retrofit windows, excess DPC is cut off after window is fitted.

Support

Windows should be supported on durable packings at a maximum of 150mm from each jamb and beneath mullions. The window should be fitted level and plumb (Figure 3). When building-in, continuous support at sill level can be provided by a mortar bed.

Figure 3

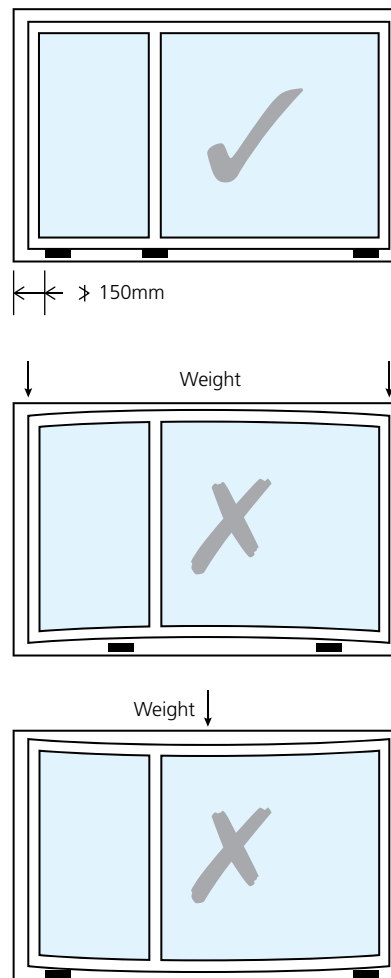

Support for the frame should such as to prevent distortion and should not damage any protection or finish.

Side packings should be located where fixings occur and fitted without distorting the frame.

INSTALLATION AND HANDLING

Particular care is necessary when providing packings to sliding sash windows where even minor distortions can prevent the movement of the sashes or introduce excessive clearance to sashes (Figure 4).

When fitting packings it is advisable to check the operation of all types of windows prior to final fixing.

Figure 4

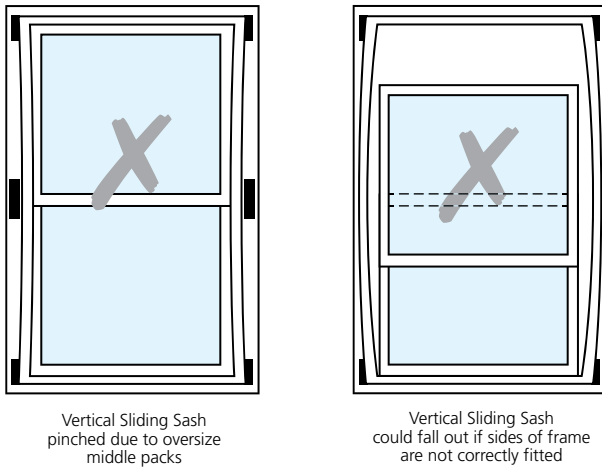

Fixing

Side fixings should be provided at 150mm from top and bottom of frame and a maximum 450mm between c/s. Where a window exceeds 1800mm in width or is formed with two or more units, fixings should be provided at head and sill (Figure 5).

Special requirements may be necessary when fixing windows into preformed openings.

Unless internally fitted fixing clips are used (Figure 6) it will be necessary to fix through the frame. Where possible, choose unobtrusive locations. If a cavity closer is used refer to the JELD-WEN UK fitting information leaflet.

Figure 5

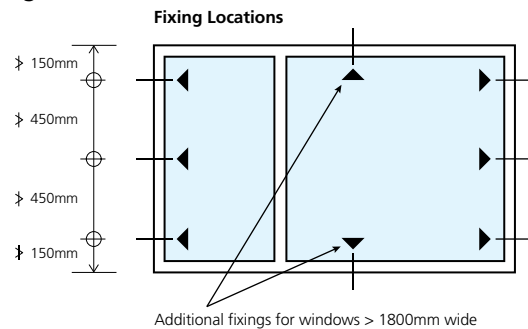

Purpose made nylon frame fixings are available. These utilise the same diameter hole through the timber as well as the substrate. The fixing is usually supplied complete with the screw.

Alternative fixings include a proprietary screw device which enables the window to be adjusted in position on the screw fixings (Figure 7).

Sealing

To prevent air infiltration between the window and adjacent wall the gap between the window and wall should be sealed. A polythene backed sealing strip can be fitted prior to building-in or alternatively an expanding foam seal or mineral wool can be fitted after building-in is completed.

These will expand after a period of time to fill the gap (Figure 6).

An additional seal can then be provided by a silicone or polysulphide based sealant.

Alternatively a timber cover strip can be provided which should be fitted over the foam seal. This strip should be cut 10mm short of the sill. This method permits any moisture which reaches the foam seal to escape.

Figure 6

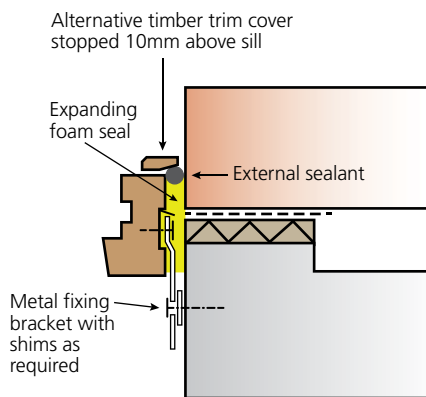

Linseed oil putty is not permitted and will invalidate the guarantee.

For advice on fitting bay windows see page 76.

We offer a survey, supply and fit service for certain schemes. Contact us for more information on **0845 122 2892**.

Doorset installation

We recommend that in all areas of extreme exposure that doorsets should be protected by a porch or canopy in addition to the recommended decorative protection. See page 159 for maintenance guidelines.

Every opening that will be having a doorset installed will need structural support such as a RSJ, lintel or timber beam. For a folding sliding patio doorset a lintel must be in place owing to its operation method.

They must have at least 150mm bearing at each end and the overall length should be a minimum of the total opening width plus 300mm. For correct product specification it is important to understand the type of construction, the type and thickness of the inner and outer leaves and the width of the cavity. It will also be necessary to understand the exposure rating for the site to determine if a cavity tray or building in check etc. is required.

The additional loads imposed by the folding sliding patio doorsets will be a uniformly distributed load (UDL) of 0.5kN (approx. 50kg) per metre run. Loads from the structure will include loads from roof trusses, floor joists and masonry.



You can view fitting videos on our YouTube page which offers practical advice whilst you are on the job including how to fit a patio door correctly.

Go to www.youtube.com/JELDWENUK or scan the QR code



CAVITY CLOSERS

The fully certified BBA cavity closer system guarantees compliance with Approved Document Approved Document L of Building Regulations when closing the cavity around the window openings.

Universal closer system

Our standard Universal cavity closer system suits 75mm and 100mm, other sizes as shown are available on a special order. Please specify which ones you need when ordering. Fixing packs are available separately. If using a thin joint mortar construction method, we can supply a thin joint brick tie on special order.

Big Blok closer system

Recognising the need for super insulated homes, we now offer a super insulating Big Blok closer which are designed to fit into the larger cavity sizes. Our Big Blok closer system suits 125mm and 150mm and other sizes as shown are available on a special order.

Fire stops

Fire stops are not normally needed in conventional masonry construction but when they are needed we offer the Flameblok cavity closer system. This is a one hour fire rated all in one cavity closer option available in 100mm, 125mm & 150mm.

Certification

These are the certification details for our cavity closer systems:

Flameblok Fire certification – Chilt/IF09035 in accordance with general principles of BSEN 1363-1:1999

BBA certification 00/3673

Our cavity closer systems are made from 100% post consumer recycled PVC-u. With an ODP and GWP of zero, this product is ideal to meet sustainable construction standards.

Frame hangers

If you are using cavity closers in a timber frame construction, please check with our technical team to ensure you choose the correct specification. Frame hangers suitable for cavities 50mm & 75mm are available to special order.

When you order a window to fit into a cavity closer, always state this on the order. Cavity closer orders will only be accepted when JELD-WEN windows are being supplied.

Brick fixing ties will automatically be added to your order when ordering a cavity closer system. Please let us know if you do not require them.

For bespoke window sizes, orders or further information on all of these systems contact the sales office.



Examples of brickwork opening sizes for windows when using cavity closers

Actual window size	Brickwork opening size
625mm x 895mm	642mm x 908mm
910mm x 1045mm	927mm x 1058mm
1195mm x 1195mm	1212mm x 1208mm
1765mm x 1345mm	1782mm x 1358mm

Cavity opening sizes	50mm	75mm	100mm	125mm	140mm	150mm	170mm	200mm	300mm
Universal	X	✓	✓	X	X	X	X	X	X
Big Blok	X	X	X	✓	SO	✓	SO	SO	SO
Flameblok	X	X	SO	SO	X	SO	X	X	X
Timber Frame Hangers	SO	SO	X	X	X	X	X	X	X

✓ = available X = not available

SO = Special order. Minimum order value applies – speak to a member of staff for more information.



In check installation detail



Big Blok closer system

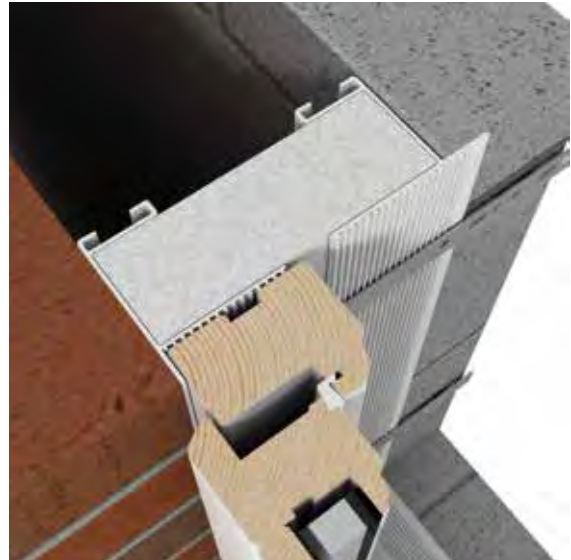

In check installation detail

WINDOW SPECIFICATION COMPARISON GUIDE

This information provides you with a comparison of the specification across our window range.

	Elegance Flush Casement	Stormsure Energy+ High Performance Casement
Operational detail	Flush casement, side and top hung	Standard casement, side and top hung
Frame section size	108mm front to back at head with standard head drip (82mm option without)	96mm from back of head to front of sash (sash sits 3mm proud of frame)
Jamb material	Engineered softwood	Engineered softwood
Frame material	Engineered softwood	Engineered softwood
Sill material	Engineered softwood	Engineered softwood
Sill sizes	Standard 91mm stub sill. Timber nosing options to create overall sizes of - 132mm, 157mm, 179mm, 207mm	Standard 158mm sill. Timber nosing options to create overall sizes of 93mm stub sill - 133mm, 183mm, 208mm
Beading (external)	Timber-composite pinless beading and black gasket on factory paint finished and glazed windows	Timber-composite pinless beading and black gasket on factory paint finished and glazed windows
Made to measure options	Yes	Yes
Hardware detail	Espagnolette multi-point locking handle and projecting hinges as standard. Safe clean projecting and fire egress hinges optional	Espagnolette multi-point locking handle and projecting hinges as standard. Safe clean projecting and fire egress hinges optional
Handles	Inline locking polished chrome standard or white, black, brushed chrome, bronze and gold options	Inline locking polished chrome standard or white, black, brushed chrome, bronze and gold options
Glazing	Double - 24mm Low-E insulating	Triple - 36mm Low-E Insulating
Bar designs	Yes optional	Yes optional
U Values (factory glazed products)	1.3-1.4 W/m ² K	0.8-1.0 W/m ² K
Energy ratings	A and B	A+ and B
Spacer bars	Black standard, white & grey optional	Black standard, white & grey optional
Ventilation detail	Recessed flush fitting vents internally as standard	Recessed flush fitting vents internally as standard
Ventilation colour	White (as standard on softwood), brown (as standard on oak windows) grey and green optional, others on request	White as standard, brown, grey and green optional, others on request
Bays	Yes	Yes
Brickwork tolerance guidance	12mm	12mm
Secured by Design	Yes optional	Yes optional
Approved Document Q	Yes optional	Yes optional
Exposure rating	2000pa	2000pa
Air permeability	Class 4	Class 4
Performance testing	BS6375: Part 1:2009	BS6375: Part 1:2009
Strength/operation testing	BS6375: Part 2:2009	BS6375: Part 2:2009
Acoustic performance	Available to 39dB	Available to 40dB
Responsibility	FSC	FSC

Stormsure Casement & Regency	Regal Box Sash	Sliding Sash
Standard casement, side and top hung	Sliding sashes with counterweight	Spiral balance, tilt in options. Assisted lift spiral balance available as a special order
93mm front to back at head	148mm front to back at the head and sill	168mm front to back at head
Engineered softwood or oak*	Engineered softwood	Engineered timber facings with extruded spiral balance channels
Engineered softwood or oak*	Engineered softwood	Engineered softwood
Softwood or oak to match frame	Engineered softwood	Softwood sill
Standard 158mm sill. Timber nosing options to create overall sizes of 93mm stub sill - 133mm, 183mm, 208mm	Standard 148mm sill, the sill sits flush with the face of the box case.	Standard 168mm sill (flush). Timber nosing options to create overall sizes of 196mm or 225mm
Timber-composite pinless beading and black gasket on factory paint finished and glazed windows	Timber-composite pinless beading and black gasket on factory paint finished and glazed windows	Timber-composite pinless beading and black gasket on factory paint finished and glazed windows
Yes	Yes	Yes
Espagnolette multi-point locking handle and projecting hinges as standard. Safe clean projecting and fire egress hinges optional	Regal fitch catch standard. Optional sash opening restrictor available upon request	Fitch catch locking as standard, non locking available to order. Optional sash opening restrictor available upon request
Inline locking polished chrome standard or white, black, brushed chrome, bronze and gold options	Polished gold locking fitch standard or chrome option	Polished chrome locking fitch standard or white, black, brushed chrome, bronze and gold options
Double - 24mm Low-E insulating	Double - 24mm Low-E insulating Single glazing available as an option	Double - 24mm Low-E insulating
Yes optional	Yes optional	Yes optional
1.3-1.4 W/m ² K	1.5 W/m ² K - excluding single glazing	1.4 W/m ² K
A and B	No performance declared	B
Black standard, white & grey optional	Black standard, white & grey optional	Black standard, white & grey optional
Recessed flush fitting vents internally as standard	Recessed flush fitting vents internally as standard	Surface mounted vents internally as standard
White (as standard on softwood), brown (as standard on oak windows) grey and green optional, others on request	White as standard	White as standard, brown optional
Yes	No	Yes
12mm	12mm	12mm
Yes optional	Not available	Yes optional
Yes optional	Not available	Yes optional
2000pa	No performance declared	2000pa
Class 4	No performance declared	Class 2
BS6375: Part 1:2009	No performance declared	BS6375: Part 1:2009
BS6375: Part 2:2009	No performance declared	BS6375: Part 2:2009
Available to 37dB	No performance declared	Available to 31dB
FSC	FSC	FSC

*Excluding Regency



GLAZING WINDOWS

JELD-WEN UK timber windows are designed to accept 24mm, 28mm or 36mm insulating glass units depending on the range, incorporating Low-E glass to comply with Building Regulations Approved Document L.

Our window glazing units come with a 10 year guarantee. Glass options shown are the most common other than clear, but if you want a different finish give us a call to discuss your requirements.

Standard obscure glass is available at the same price as clear factory glazed windows. Cotswold™ will be supplied as standard unless specified otherwise. Other options i.e. interlayer white, sand blasted and etched available at extra cost.

Leaded glass is not available for simulated divided lite windows.

Leaded lites are supplied as standard to match JELD-WEN designs. If you require equal divided designs please specify when ordering.

All bar simulated divided lite designs are supplied with JELD-WEN standard division. If you require equal divided lites please specify at time of order.

Glazing options



Cotswold™



Autumn™



Flemish™

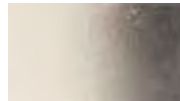

Stippolyte™



Diamond leaded*

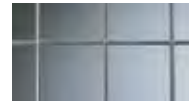

Rectangular leaded*

* Not available with simulated divided lite design

Energy rated options

For windows **Energy rated A** and above will be supplied with Pilkington Optiwhite™ outer pane as standard. This is available as an optional extra on other windows, please enquire.

For windows **Energy rated B** and under will be supplied with Pilkington Optifloat™ KS as standard.



Pilkington
Optiwhite™

Pilkington
Optifloat™ KS

Pilkington Optiwhite™ is a low-iron extra clear float glass with very high light transmission. It is practically colourless, and the green cast inherent to other glasses is not present. It is therefore ideal for use where glass edges are visible or where a neutral colour is desired. As its light transmission is higher than clear float glass, it is perfect for applications where transparency and purity of colour are desired.

Benefits

- High light transmission for outstanding visual clarity when an unrestricted view is required
- Purity of colour with minimum colour cast when viewing through the glass, ensuring a truer representation of the designer's vision
- High solar heat transmittance providing passive solar gain to allow more heat through, which can save costs on energy bills during the winter
- Flexibility of application
- Can be toughened or laminated for safety and security

Bar designs

Simulated divided lite windows have timber bonded fret bars on the outside and inside with an aluminium integral bar in the glass unit and gives better thermal performance than a traditional divided lite. This is available across the whole window range.

Triple glazed windows with bars have timber frets inside and outside however no integral bar inside.

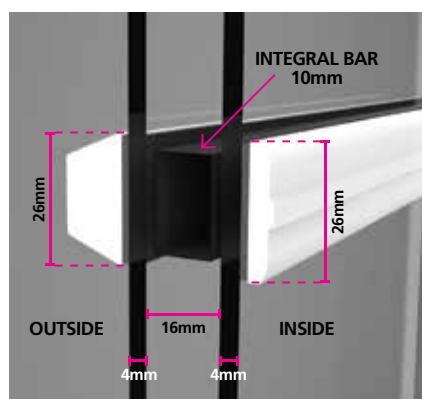

Simulated bars double glazed

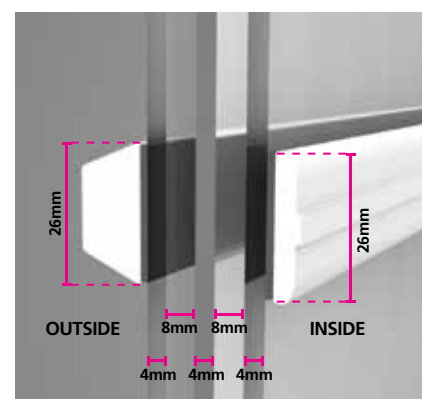

Simulated bars triple glazed

Spacer bars

Standard warm edge spacer bars are supplied in black but grey and white are also available upon request.



White spacer bar



Black spacer bar



Silver spacer bar

THERMAL TRANSMITTANCE

The thermal performance of external joinery is an important consideration when specifying products to ensure their performance meets the required standards.

Thermal transmittance, also known as *U* value is the rate of transfer of heat (in watts) through one square metre of a structure divided by the difference in temperature across the structure. It is expressed in watts per metres squared kelvin, or W/m^2K . Well insulated parts of a building have a low thermal transmittance whereas poorly insulated parts of a building have a high thermal transmittance.

U values in windows are calculated in accordance with ISO-10077-2. Thermal performance of windows and doorsets is affected by various elements of the design including timber section size, glass specification and weather seals. JELD-WEN aims to offer a range of different products covering different *U* values to suit your requirements. Below is a graph which illustrates a comparison with how our standard ranges compare to provide guidance on range selection.

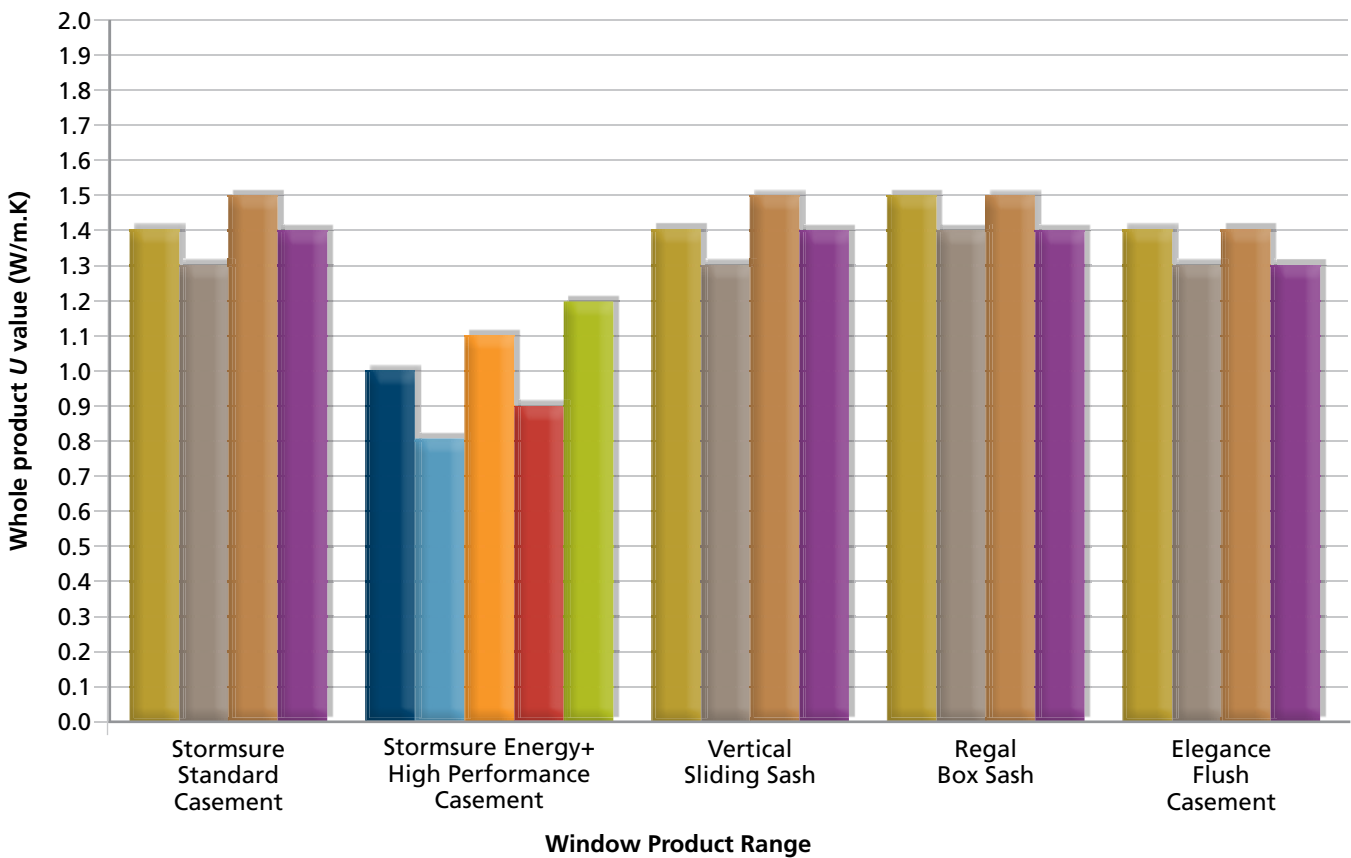

Key to Glazing Specification (mm)

- 4-16-4 Standard Low-E
- 4-16-4 Super Low-E
- 4-14-6.8 Standard Low-E
- 4-14-6.8 Super Low-E
- 4-12-4-12-4 Standard Low-E
- 4-12-4-12-4 Super Low-E
- 4-12-4-10-6.8 Standard Low-E
- 4-12-4-10-6.8 Super Low-E
- 4-12-4-12-4 Super Low-E (Argon)

ACOUSTIC RATINGS

The increased focus on environment and indoor climate calls for high acoustic quality levels in buildings.

Acoustic reductions are required for certain sites in order to comply with Planning Policy Guidance 24 (PPG24), World Health Organisation (WHO) and BS 8233:1999 - Sound insulation and noise reduction in buildings. These standards and policies outline acceptable noise levels within dwellings. PPG24 recognises that windows in a facade are the most common transmission pathway

for external noise. Therefore windows and doorsets can be specified with higher performance characteristics which will assist in reducing this transmission of sound in line with an acoustics site specific acoustic report. Below is a graph illustrating how our range of windows compare to provide guidance on range selection

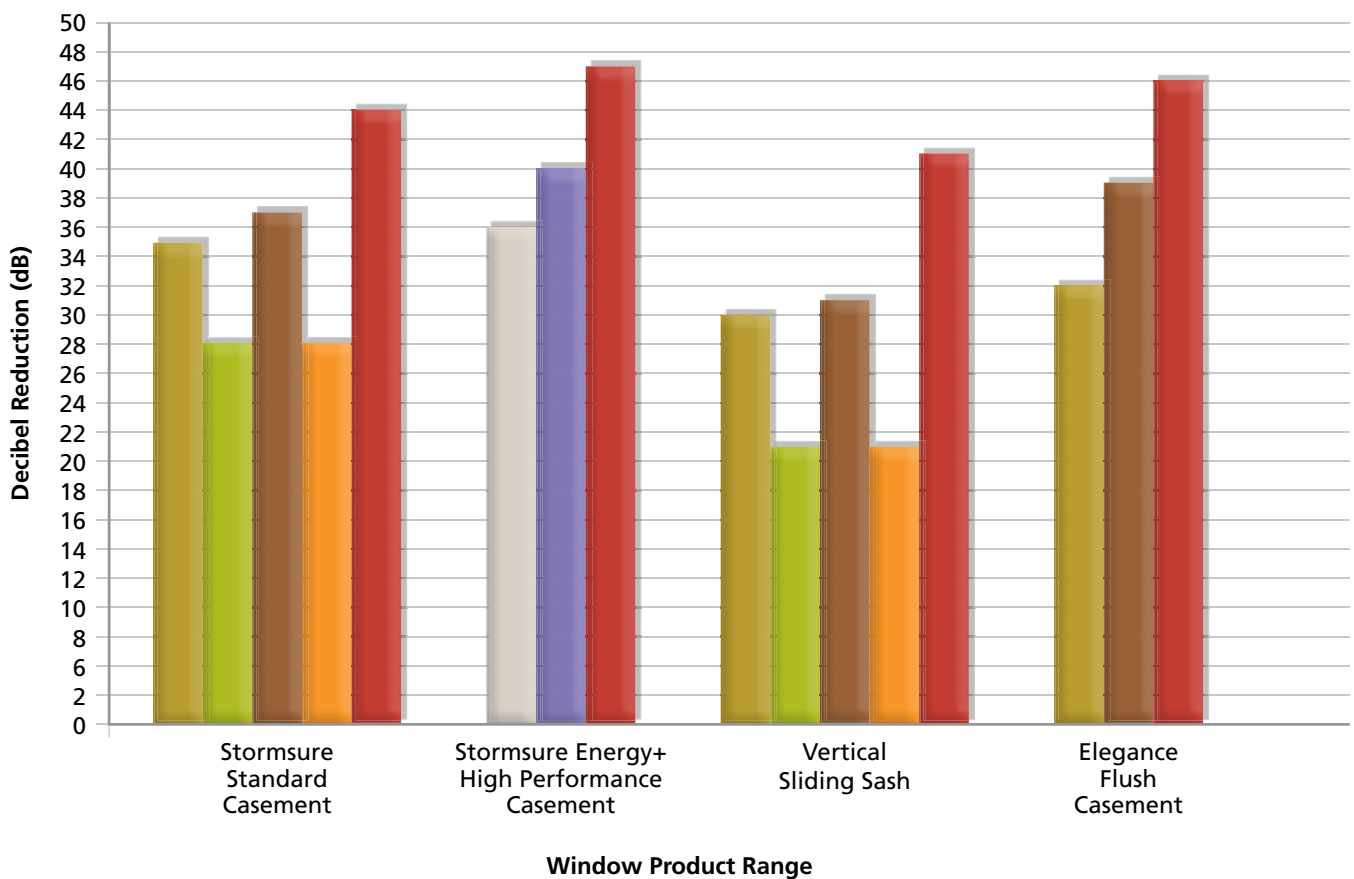

Key to Glazing Specification (mm)

- 4-16-4 No vents
- 4-16-4 Vents closed
- 4-14-6.8 Acoustic glass No vents
- 4-14-6.8 Acoustic glass Vents closed
- 4-12-4-12-4 No vents
- 4-12-4-10-6.8 Acoustic glass No vents
- Secondary glazing

REGAL BOX SASH

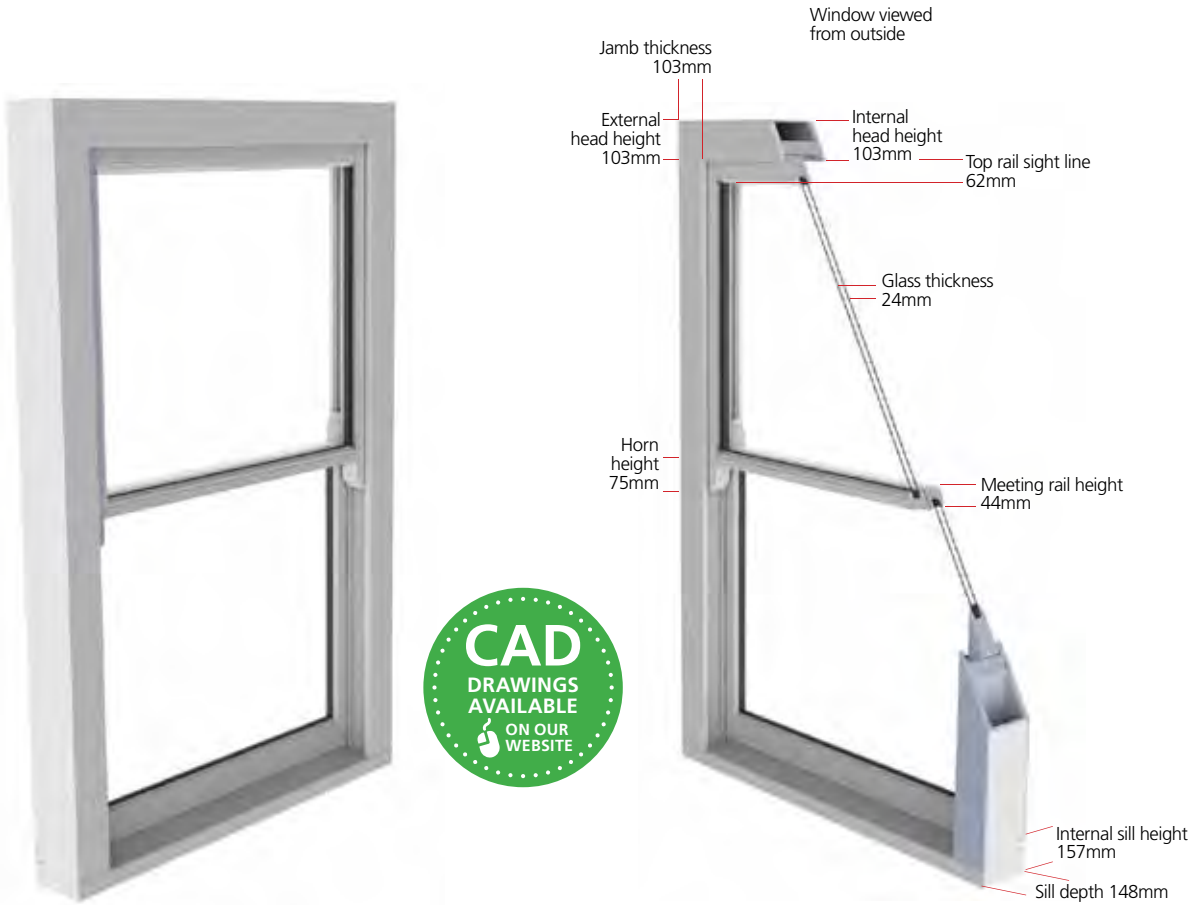

Our new high specification Regal Box Sash timber window range has a true weights and pulleys system that provides a direct replacement for an original box sash window, or creates a high quality traditional look for a new build.

- U values available 1.5 W/m²K
- Engineered softwood timber
- Frame depth 148mm
- True weights and pulleys operation
- Double glazed with black warm edge spacer bar as standard, single glazing available as an option
- Polished gold locking fitch catch and lift as standard
- Pinless beading on factory paint finished and glazed windows
- Fully finished in Hi-Build white paint as standard, other RAL colour options available on request. See page 152 for more information
- Available with JELD-WEN survey, supply and installation service

- Made to measure with minimum and maximum sizes. CAD drawings are available on our website
- Horns standard
- Bar designs available upon request
- Factory glazed windows are CE Marked, see page 26 for glazing options
- FSC certified, Chain of Custody on request
- For full specification details see page 24





Glazing

Using glazing rebates of 18mm x 41mm Regal Box Sash windows will accept 24mm (4:16:4) insulating glass units as standard. The glazing system is drained and vented with a 5mm clearance between the insulating glass unit and rebate, in compliance with BS 6262.

Ventilation

Face fixed Titon Trimvent® select ventilators are fitted as standard to all Vertical Sliding windows to assist in compliance with Approved Document F of the Building Regulations. These provide an Equivalent Area of 5214mm² fitted on windows 860mm and wider and 2607mm² on windows below that size. Windows below 488mm wide are not fitted with ventilators. This product is also available with no trickle ventilation at time of order.

Sill Detail

A standard 148mm sill is available as well as extended sills to widths of 264mm. Care must be taken to ensure that the correct sill width is specified to suit the brickwork detail and Approved Document L amendments.

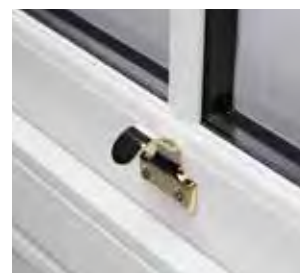

U available down to: 1.5 Wm²K



Fire egress available to assist with compliance of Approved Document B



Background ventilation provided, to assist with compliance of Approved Document F

SECTION DETAILS

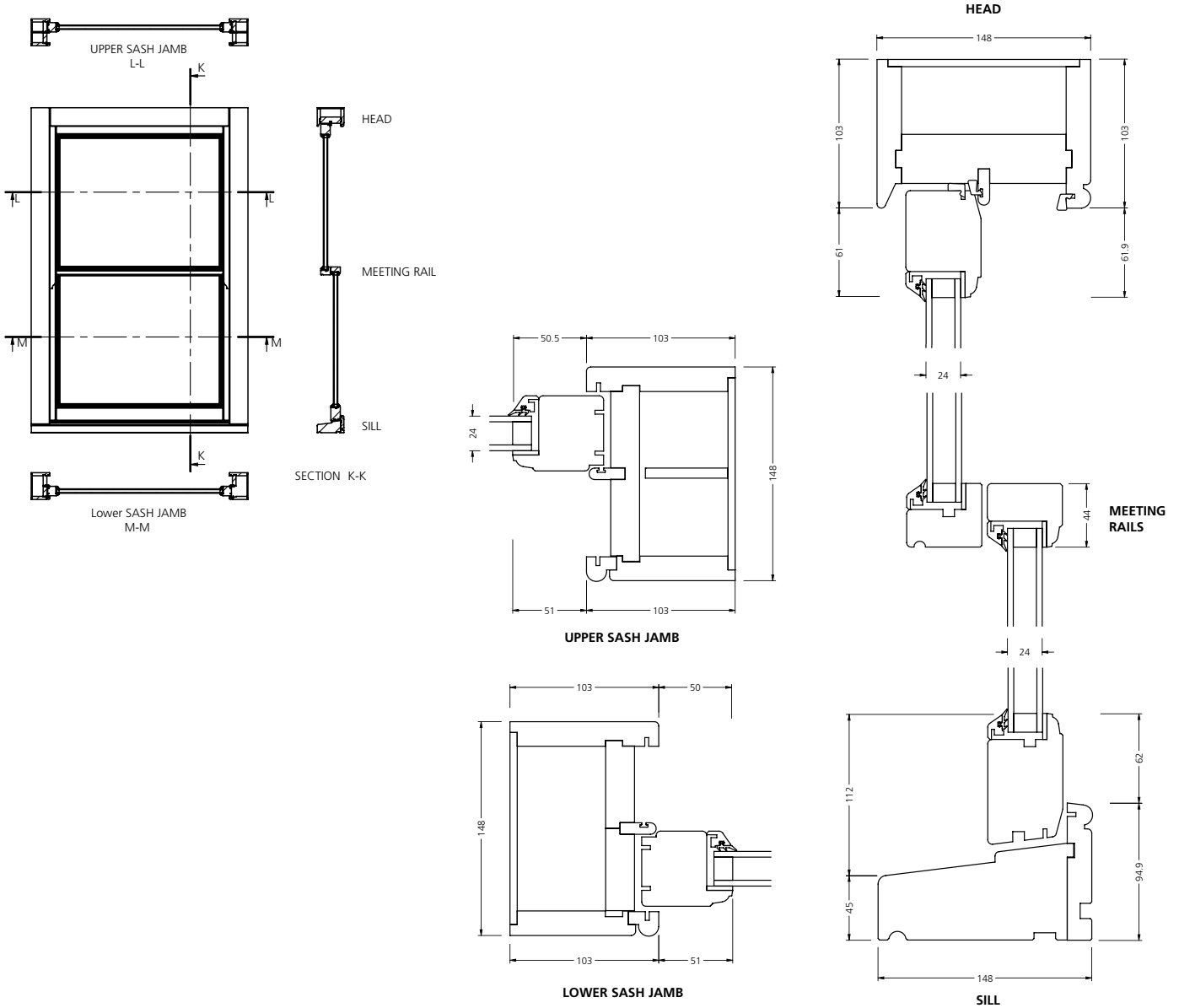

SIZE LIMITATIONS

Our Regal Box Sash range is available as made to measure. When specifying made to measure products, the below limitations should be used as a guide to what can be manufactured.

	Min Frame Width (mm)	Min Frame Height (mm)	Max Frame Width (mm)	Max Frame Height (mm)
Frame and sash	486	851	1200	2800

Please note, configuration limitations vary within the min/max dimensions due to weight and sash proportions. For further detailed sizing please contact our estimating department on 0845 1222892.

PURGE VENTILATION AND DAYLIGHT AREA FIGURES

Purge ventilation is manually controlled ventilation of rooms or spaces at a relatively high rate to rapidly dilute pollutants and/or water vapour. Purge ventilation may be provided by natural means, eg. by a window that opens, or by mechanical means eg. a fan. For a window that opens 30° or more or for vertical sliding sash windows, the height x width of the opening part should be at least 1/20th of the floor area of the room. The same rule applies to windows opening between 15° - 30°, however the width x height should be at least 1/10th of the floor area. If the window opens less than 15°, then the window is not suitable for purge ventilation and other arrangements should be made. All of our windows when specified as opening will open past 30° unless a permanent restrictor is specified.

Below we provide purge ventilation and daylight figures for our standard sized products. If you require these figures for a made to measure product, then please follow the below calculation using the illustration provided.

Calculation for daylight figures

Width: Overall frame width (mm) minus A's

Height: Overall frame height (mm) minus B's

Width x height = mm² of daylight

Calculation for purge ventilation figures

Width: Overall frame width (mm) minus C's

Height: Overall frame height (mm) minus D's

Width x height = mm² of purge ventilation

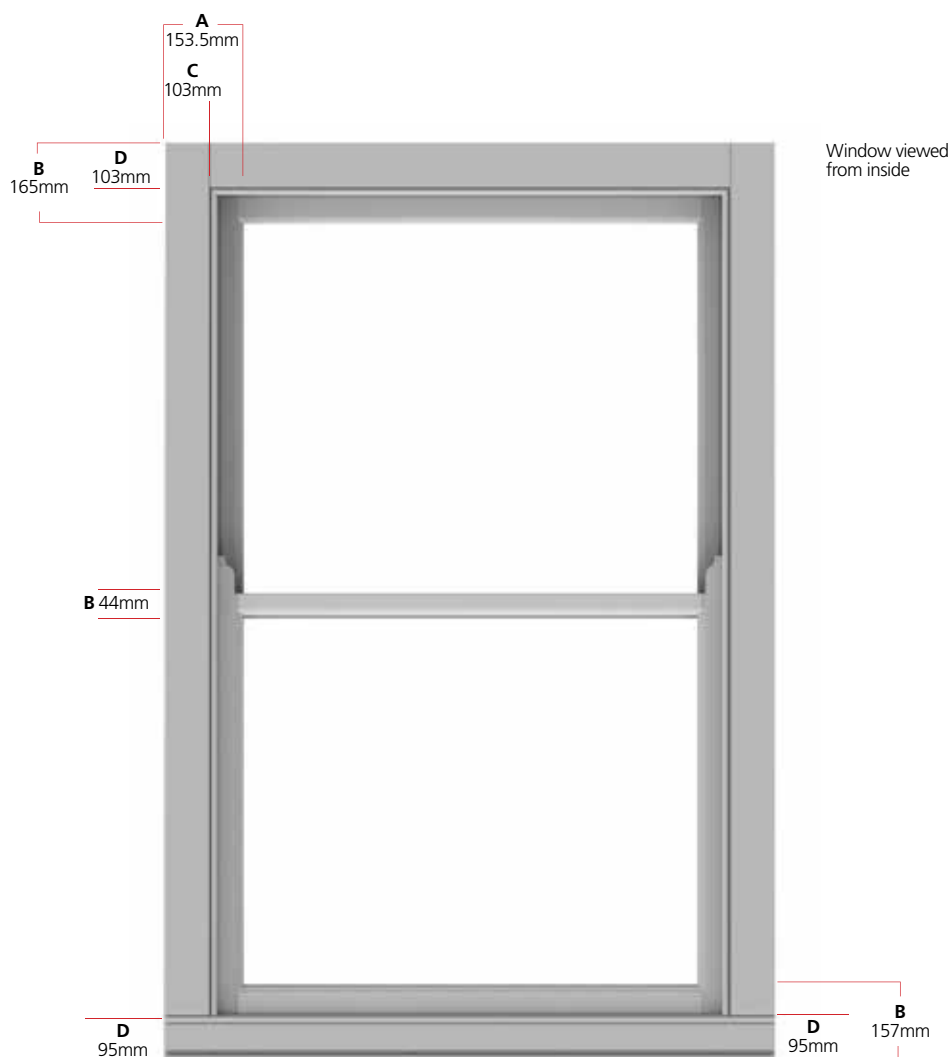

ELEGANCE FLUSH CASEMENT



Our Elegance casement window has a flush sash design that's based on traditional techniques, perfect for conservation projects. With its chunky 82mm frame, it instantly adds a contemporary twist and modern energy efficient performance to a traditional building.

- U values available 1.3-1.4 W/m²K, BFRC energy rated A-B
- Engineered softwood timber
- Double glazed with black warm edge spacer bar as standard, white and grey optional
- Design options – Standard, Victorian Bar, Horizontal Bar, All Bar, Cottage Bar, Deco Bar, Regency and Designer available
- Espagnolette multi-point locking and projecting hinges as standard. Fire egress projecting hinge option available where indicated
- Hardex polished chrome handles as standard. Other options including monkey tail design available, see page 156 for more hardware information
- Factory finished in Hi-Build white paint as standard, other RAL colour options available – see page 152 for finishing details
- Standard and made to measure sizes available. CAD drawings are available on our website
- Factory glazed windows are CE Marked, see page 26 for glazing options
- Actual frame size quoted
- FSC certified, Chain of Custody on request
- Approved Document M – low level handles and cord operated ventilators are available as an optional extra
- Non-opening glazed areas are supplied with fixed sashes as standard
- PAS 24 specification options available to meet the requirements of Approved Document Q and Secured by Design
- Pinless beading on factory paint finished and glazed windows
- RIBA timber window CPD seminar available, book online
- For full specification details see page 24





Glazing

Using glazing rebates of 18mm x 41mm Elegance flush casement windows will accept 24mm (4:16:4) insulating glass units as standard. The glazing system is fully drained and vented with a sloping bottom platform. A full 5mm clearance is provided between the insulating glass unit and rebate, in compliance with BS 6262.

Ventilation

Flush fitting ventilators are supplied fitted as standard to all Elegance windows to assist in compliance with Approved Document F of the Building Regulations. These provide an Equivalent Area of 6100mm² on windows 888mm and wider, 3050mm² on windows below that size, down to 465mm wide. This product is also available with no trickle ventilation at time of order.

Sill Detail

A narrow 91mm and an 82mm flush sill is available as well as extended sills to widths of 208mm. Care must be taken to ensure that the correct sill width is specified to suit the brickwork detail and Approved Document L.

PLAIN GLAZED AND BAR DESIGN OPTIONS



Plain



Victorian Bar



Cottage Bar



Horizontal Bar



Deco Bar



All Bar



U available down to: 1.3 Wm²K



Fire egress available to assist with compliance of Approved Document B



Background ventilation provided, to assist with compliance of Approved Document F



SECTION DETAILS

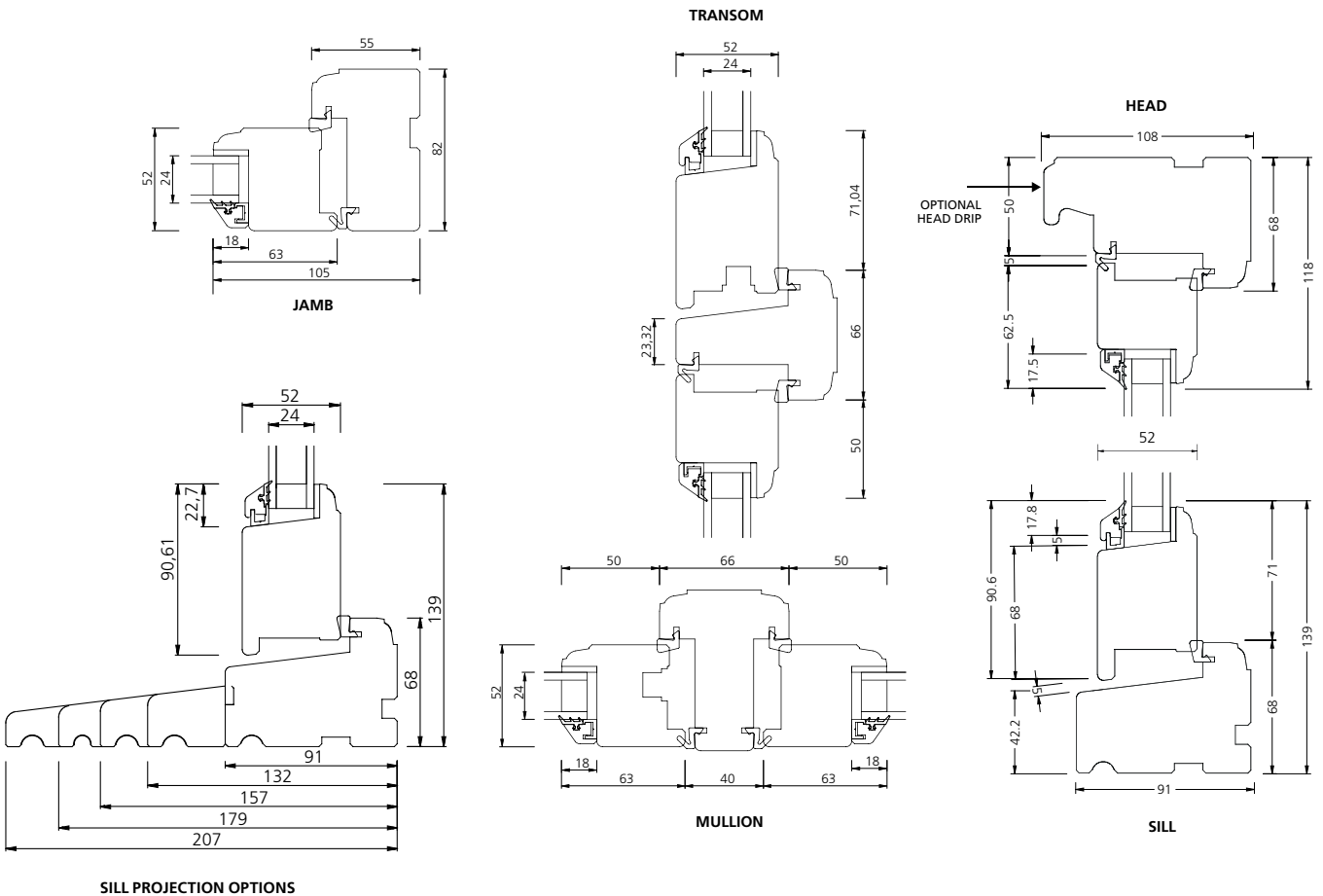
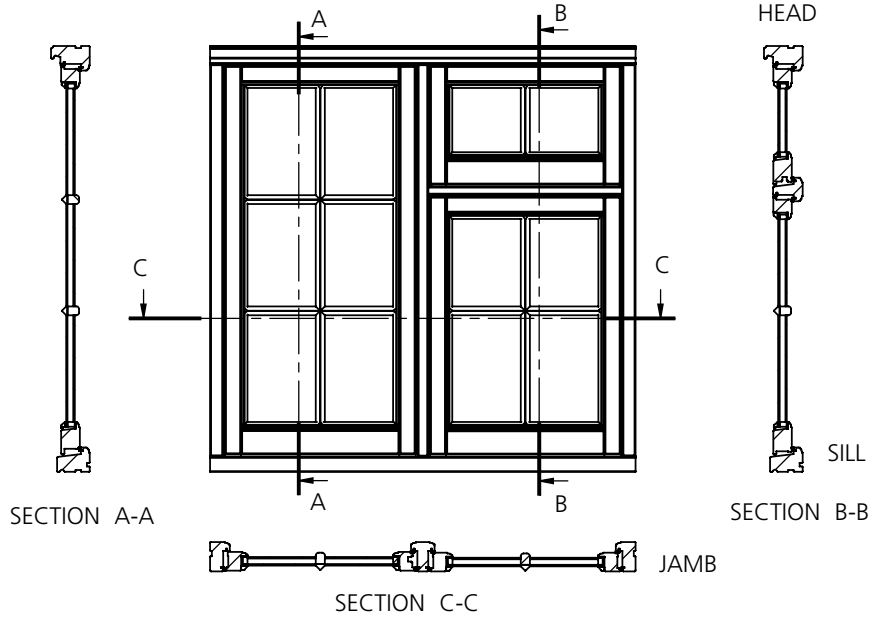

SIZE LIMITATIONS

Our Elegance casement range is available as standard sizes or made to measure. When specifying made to measure products, the below limitations should be used as a guide to what can be manufactured.

	Min Sash Width (mm)	Min Sash Height (mm)	Max Sash Width (mm)	Max Sash Height (mm)
Side hung	400	400	800	1600
Top hung	400	400	1200	1480

Limitations for projecting hinges

	Min Frame Width (mm)	Min Frame Height (mm)	Max Frame Width (mm)	Max Frame Height (mm)	Max Frame Area (mm ²)
Frame	484	484	3000	2400	2500

Including fixed sash

Please note, configuration limitations vary within the min/max dimensions due to weight and sash proportions. For further detailed sizing please contact our estimating department on 0845 1222892.

Fire Egress Frame – Mullion detail

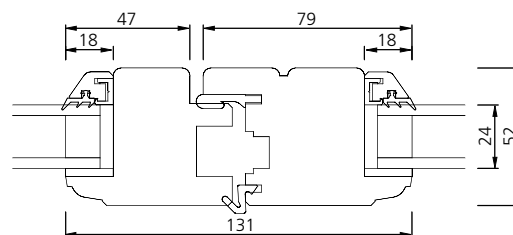
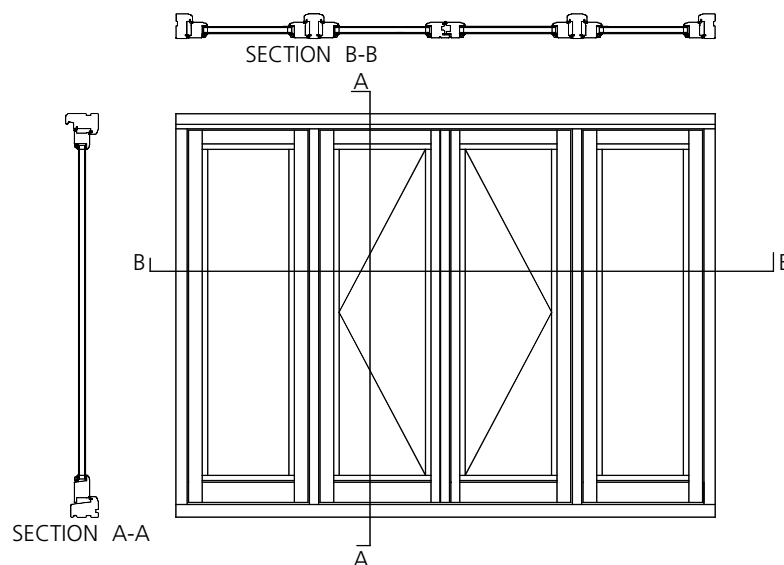

MULLION

ACOUSTIC PERFORMANCE

External noise reduction is required from various different sources. These can either be road traffic, air traffic, rail or pedestrians. Depending on the different sources, certain frequencies will be relatively higher which results in a significant reduction required for this specific band of frequency. These tables detail these bands, which will enable you to see the exact performance of the product.

Elegance flush casement (4-16-4)

No vents

Freq F HZ	Sound Reduction Index, dB	
	1/3 Octave	1/1 Octave
100	26.8	24.9
125	22.8	
160	25.1	
200	19.3	21.6
250	20.4	
315	25	
400	27.2	29.4
500	28.2	
630	32.7	
800	35	37.7
1000	37.5	
1250	40.6	
1600	42	39.6
2000	40.6	
2500	36.2	
3150	29.3	34.0
4000	32.9	
5000	39.7	

Rating according to BS EN ISO 10140-2:2010

RW (C;Ctr) = 32 (-0;-3) dB

Elegance flush casement (4-14-6.8)

No vents

Freq F HZ	Sound Reduction Index, dB	
	1/3 Octave	1/1 Octave
100	26.6	25.1
125	24.4	
160	24.4	
200	22.7	28.2
250	29.5	
315	32.3	
400	33.3	35.3
500	34.6	
630	38	
800	41.4	41.9
1000	41.7	
1250	42.6	
1600	43.9	42.8
2000	43.2	
2500	41.2	
3150	37.8	40.2
4000	39.9	
5000	42.9	

Rating according to BS EN ISO 10140-2:2010

RW (C;Ctr) = 39 (-1;-5) dB

PURGE VENTILATION AND DAYLIGHT AREA FIGURES

Purge ventilation is manually controlled ventilation of rooms or spaces at a relatively high rate to rapidly dilute pollutants and/or water vapour. Purge ventilation may be provided by natural means, eg. by a window that opens, or by mechanical means eg. a fan. For a window that opens 30° or more or for vertical sliding sash windows, the height x width of the opening part should be at least 1/20th of the floor area of the room. The same rule applies to windows opening between 15° - 30°, however the width x height should be at least 1/10th of the floor area. If the window opens less than 15°, then the window is not suitable for purge ventilation and other arrangements should be made. All of our windows when specified as opening will open past 30° unless a permanent restrictor is specified.

Below we provide purge ventilation and daylight figures for our standard sized products. If you require these figures for a made to measure product, then please follow the below calculation using the illustration provided.

Calculation for daylight figures

Width: Overall frame width (mm) minus A's
 Height: Overall frame height (mm) minus B's
 Width x height = mm² of daylight

Calculation for purge ventilation figures

Width: Overall frame width (mm) minus C's
 Height: Overall frame height (mm) minus D's
 Width x height = mm² of purge ventilation

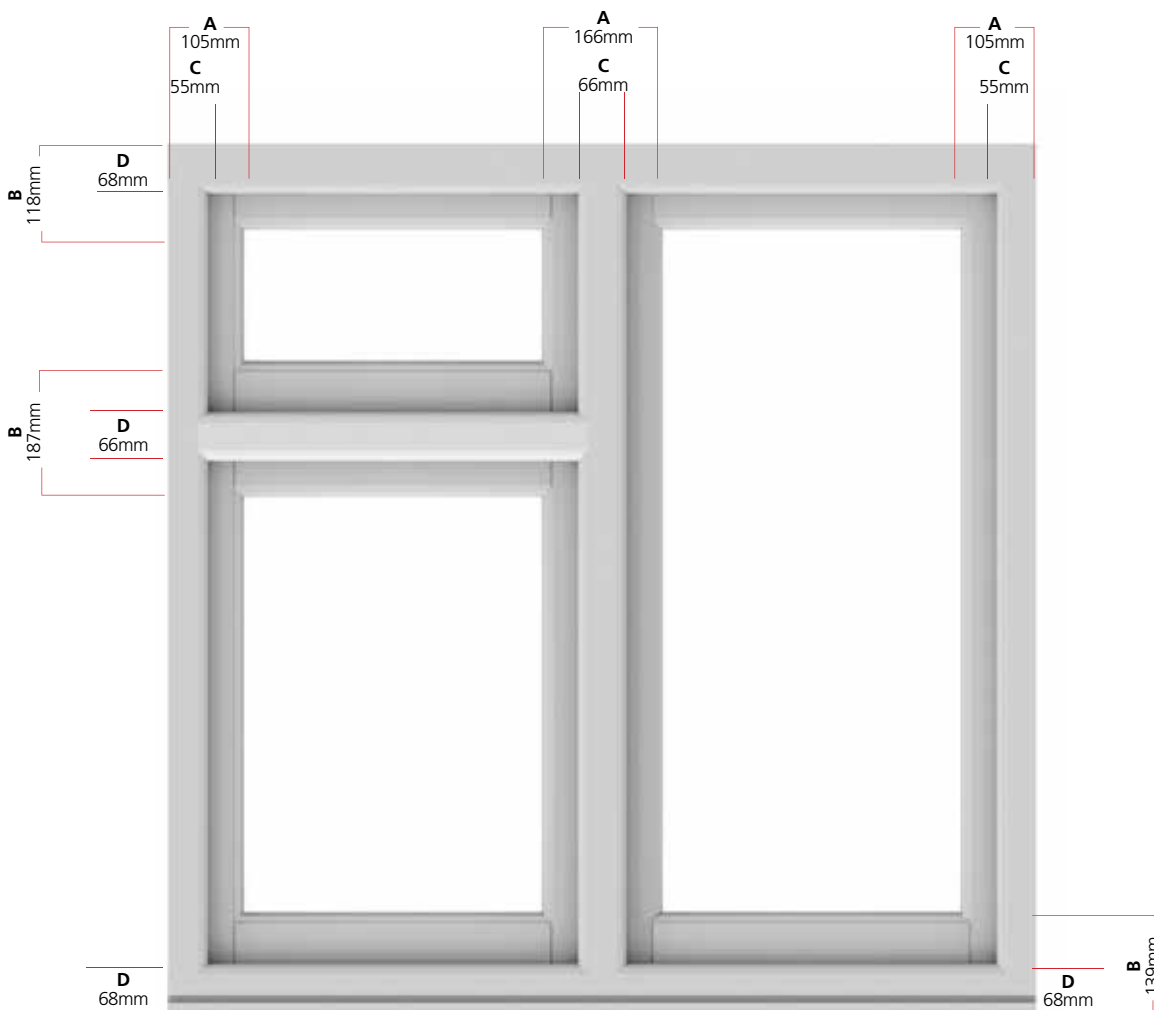

Internal view

ELEGANCE CASEMENT

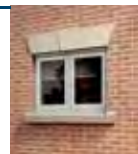
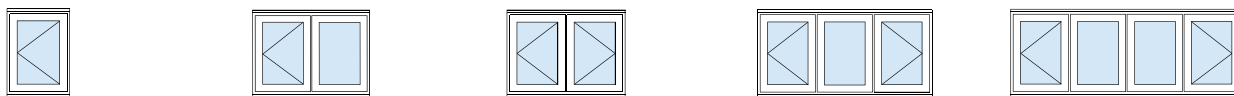

Height	Width 588mm	D mm ²	V mm ²	Width 1188mm	D mm ²	V mm ²	Width 1188mm	D mm ²	V mm ²	Width 1788mm	D mm ²	V mm ²	Width 2388mm	D mm ²	V mm ²
738	SLEEN07C	181818	287738	SLEE2N07C	390536	304572	SLEE2N07CC	390536	609144	SLEE3N07CC	599326	620371	SLEE4N07CMC	808101	625953
888	SLEEN09C	238518	359435	SLEE2N09C	512330	380466	SLEE2N09CC	512330	760932	SLEE3N09CC	786226	774956	SLEE4N09CMC	1060080	781932
1038	SLEEN10C	295218	431132	SLEE2N10C	634124	456360	SLEE2N10CC	634124	912720	SLEE3N10CC	973126	929541	SLEE4N10CMC	1312080	937911
1188	SLEEN12C	351918	502829	SLEE2N12C	755918	532254	SLEE2N12CC	755918	1064508	SLEE3N12CC	1160026	1084126	SLEE4N12CMC	1564080	1093890
1338	SLEEN13C	408618	574526	SLEE2N13C	877712	608148	SLEE2N13CC	877712	1216296	SLEE3N13CC	1346926	1238711	SLEE4N13CMC	1816080	1249869

D = Daylight mm² V = Ventilation mm²

ELEGANCE CASEMENT – NARROW MODULE

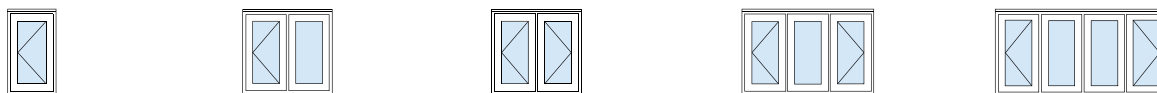

Height	Width 438mm	D mm ²	V mm ²	Width 888mm	D mm ²	V mm ²	Width 888mm	D mm ²	V mm ²	Width 1338mm	D mm ²	V mm ²	Width 1788mm	D mm ²	V mm ²
738	SLEEN07C	109668	197441	SLEE2N07C	246242	214278	SLEE2N07CC	246242	428556	SLEE3N07CC	382876	439786	SLEE4N07CMC	808080	625953
888	SLEEN09C	143868	246638	SLEE2N09C	323036	267672	SLEE2N09CC	323036	535344	SLEE3N09CC	502276	549371	SLEE4N09CMC	1060080	781932
1038	SLEEN10C	178068	295835	SLEE2N10C	399830	321066	SLEE2N10CC	399830	642132	SLEE3N10CC	621676	658956	SLEE4N10CMC	1312080	937911
1188	SLEEN12C	212268	345032	SLEE2N12C	476624	374460	SLEE2N12CC	476624	748920	SLEE3N12CC	741076	768541	SLEE4N12CMC	1564080	1093890
1338	SLEEN13C	246468	394229	SLEE2N13C	553418	427854	SLEE2N13CC	553418	855708	SLEE3N13CC	860476	878126	SLEE4N13CMC	1816080	1249869

D = Daylight mm² V = Ventilation mm²

ELEGANCE CASEMENT – NARROW MODULE FIRE ESCAPE



Height	Width 888mm	D mm ²	V mm ²	Width 1338mm	D mm ²	V mm ²	Width 1788mm	D mm ²	V mm ²	Width 1788mm	D mm ²	V mm ²
888	SLEE2N09FE	323036	535344	SLEE3N09FE	502276	824066	SLEE4N09FE	681480	834575	SLEE4N09FEC	681480	556407
1038	SLEE2N10FE	399830	642132	SLEE3N10FE	621676	988445	SLEE4N10FE	843480	1001051	SLEE4N10FEC	843480	667395
1188	SLEE2N12FE	476624	748920	SLEE3N12FE	741076	1152824	SLEE4N12FE	1005480	1167527	SLEE4N12FEC	1005480	778383
1338	SLEE2N13FE	553418	855708	SLEE3N13FE	860476	1317203	SLEE4N13FE	1167480	1334003	SLEE4N13FEC	1167480	889371

D = Daylight mm² V = Ventilation mm²

ELEGANCE CASEMENT - FIXED SASH



Height	Width 588mm	D mm ²	V mm ²	Width 1188mm	D mm ²	V mm ²
438	SLEE104CFS	68418	0	SLEE204CFS	177018	0
588	SLEE106CFS	125118	0	SLEE206CFS	323718	0
738	SLEE107CFS	181818	0	SLEE207CFS	470418	0
888	SLEE109CFS	238518	0	SLEE209CFS	617118	0
1038	SLEE110CFS	295218	0	SLEE210CFS	763818	0
1188	SLEE112CFS	351918	0	SLEE212CFS	910518	0
1338	SLEE113CFS	408618	0	SLEE213CFS	1106118	0



D = Daylight mm² V = Ventilation mm² Fixed sash window is a non-opening window.

ELEGANCE CASEMENT – WITH VENTS

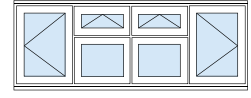
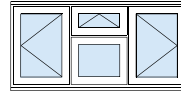
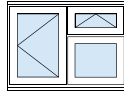
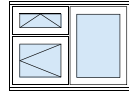

Height	Width 588mm	D mm ²	V mm ²	Width 1188mm	D mm ²	V mm ²	Width 1188mm	D mm ²	V mm ²	Width 1788mm	D mm ²	V mm ²	Width 2388mm	D mm ²	V mm ²
738	SLEE107V	111132	166805				SLEE207CV	314650	481175	SLEE307CVC	525008	804415	SLEE407CVVC	661109	983467
888	SLEE109V	167832	166805	SLEE209T	436450	347090	SLEE209CV	436450	557072	SLEE309CVC	713108	959809	SLEE409CVVC	913109	1136167
1038	SLEE110V	224532	166805	SLEE210T	558250	422987	SLEE210CV	558250	632969	SLEE310CVC	901208	1115203	SLEE410CVVC	1165109	1288866
1188	SLEE112V	281232	166805	SLEE212T	680050	498884	SLEE212CV	680050	708866	SLEE312CVC	1089308	1270597	SLEE412CVVC	1417109	1441566
1338	SLEE113V	337932	166805	SLEE213T	801850	574781	SLEE213CV	801850	784763	SLEE313CVC	1277408	1425991	SLEE413CVVC	1669109	1594265
1488	SLEE115V	394632	166805	SLEE215T	923650	650678									

ELEGANCE CASEMENT - LANDSCAPE WITH VENTS

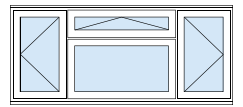
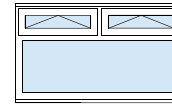
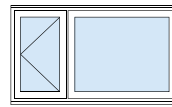
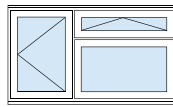
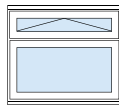
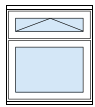

Height	Width 888mm	D mm ²	V mm ²	Width 1188mm	D mm ²	V mm ²	Width 1788mm	D mm ²	V mm ²	Width 1788mm	D mm ²	V mm ²	Width 1788mm	D mm ²	V mm ²	Width 2388mm	D mm ²	V mm ²
888	SLEE2N09W	301032	271496	SLEE209W	434232	376187	SLEE309CW	703224	767307	SLEE309C	890972	382013	SLEE309WW	626928	562584	SLEE409CWC	972661	1158746
1038	SLEE2N10W	402732	271496	SLEE210W	580932	376187	SLEE310CW	915024	843507	SLEE310C	1102772	458213	SLEE310WW	838728	562584	SLEE410CWC	1249711	1311146
1188	SLEE2N12W	504432	271496	SLEE212W	727632	376187	SLEE312CW	1126824	919706	SLEE312C	1314572	534413	SLEE312WW	1050528	562584	SLEE412CWC	1526762	1463545
1388	SLEE2N13W	640032	271496	SLEE213W	923232	376187	SLEE313CW	1409224	1021306	SLEE313C	1596972	636012	SLEE313WW	1332928	562584	SLEE413CWC	1896162	1666745
1488	SLEE2N15W	707832	271496	SLEE215W	1021032	376187							SLEE315WW	1474128	562584			

ELEGANCE CASEMENT - TRANSOM

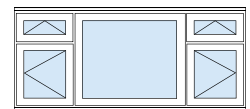
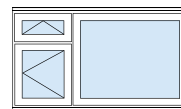
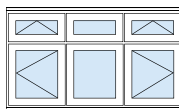
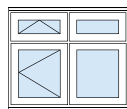
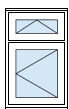

Height	Width 588mm	D mm ²	V mm ²	Width 1188mm	D mm ²	V mm ²	Width 1788mm	D mm ²	V mm ²	Width 1788mm	D mm ²	V mm ²	Width 2388mm	D mm ²	V mm ²
888	SLEE109T	167832	327874	SLEE209TX	360528	347113	SLEE309TXT	553447	707261	SLEE309T	814676	348485	SLEE409TT	1010973	696973
1038	SLEE110T	224532	399571	SLEE210TX	482328	423013	SLEE310TXT	740422	861911	SLEE310T	1026476	424685	SLEE410TT	1287574	849373
1188	SLEE112T	281232	471268	SLEE212TX	604128	498912	SLEE312TXT	927397	1016560	SLEE312T	1238276	500884	SLEE412TT	1564174	1001772
1338	SLEE113T	337932	542965	SLEE213TX	725928	574812	SLEE313TXT	1114372	1171210	SLEE313T	1450076	577084	SLEE413TT	1840774	1154172
1488	SLEE115T	394632	614662	SLEE215TX	847728	650712	SLEE315TXT	1301347	1325859	SLEE315T	1661876	653284	SLEE415TT	2117374	1306572

ELEGANCE CASEMENT – TOP HUNG

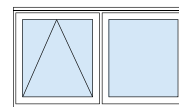
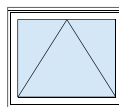
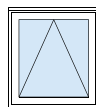
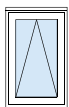

Height	Width 588mm	D mm ²	V mm ²	Width 888mm	D mm ²	V mm ²	Width 1188mm	D mm ²	V mm ²	Width 1788mm	D mm ²	V mm ²
438	SLEE104A	68418	144344	SLEE2N04A	122718	234938	SLEE204A	177018	325532	SLEE304AE	255536	243372
588	SLEE106A	125118	216041	SLEE2N06A	224418	351635	SLEE206A	323718	487229	SLEE306AE	467330	364266
788	SLEE107A	200718	311637	SLEE2N07A	360018	507231	SLEE207A	470418	648926	SLEE307AE	749722	525458
888	SLEE109A	238518	359435	SLEE2N09A	427818	585029	SLEE209A	617118	810623	SLEE309AE	890918	606054
1038	SLEE110A	295218	431132	SLEE2N10A	529518	701726	SLEE210A	763818	972320	SLEE310AE	1102712	726948
1188	SLEE112A	351918	502829	SLEE2N12A	631218	818423	SLEE212A	910518	1134017	SLEE312AE	1314506	847842



STORMSURE ENERGY+ HIGH PERFORMANCE CASEMENT



Our new Stormsure Energy+ casement window range comes with an A+ rating and U values down to $0.8W/m^2K$ for the best in energy performance.

- U values available $0.8-1.0 W/m^2K$, BFRC energy rated A+
- Engineered softwood timber
- Sash depth 68mm
- Triple glazed with warm edge black spacer bar as standard, white and grey optional
- Design options – Standard, Victorian Bar, Horizontal Bar, All Bar, Cottage Bar, Deco Bar, Regency and Designer available
- Hardex polished chrome handles as standard. Other options available see page 156 for more hardware information
- Espagnolette multi-point locking and projecting hinges as standard. Fire egress projecting hinge option available where indicated
- Standard, made to measure and imperial sizes available
- Factory finished in Hi-Build white paint as standard, other RAL colour options available – see page 152 for finishing details
- CAD drawings are available on our website
- Approved Document M – low level handles and cord operated ventilators are available as an optional extra
- Factory glazed windows are CE Marked, see page 26 for glazing options
- Non-opening areas are supplied with fixed sashes as standard
- RIBA timber window CPD seminar available, book online
- FSC certified, Chain of Custody on request
- Pinless beading on factory paint finished and glazed windows
- PAS 24 specification options available to meet the requirements of Approved Document Q and Secured by Design
- For full specification details see page 24





Glazing

The Stormsure Energy+ range incorporates 18mm x 55mm glazing rebates, accepting a 36mm (4:12:4:12:4) insulating glass units. The glazing system is fully drained and vented with a sloping bottom platform. A full 5mm clearance is provided between the insulating glass unit and rebate, in compliance with BS 6262.

Ventilation

Flush fitting ventilators are supplied fitted as standard to all Stormsure Energy+ windows to assist in compliance with Approved Document F of the Building Regulations. These provide an Equivalent Area of 6100mm² on windows 915mm and wider, 3050mm² on windows below that size, down to 488mm² wide. This product is also available with no trickle ventilation at time of order.

Sill Detail

A narrow 93mm stub sill is available as well as extended sills to widths of 208mm. Care must be taken to ensure that the correct sill width is specified to suit the brickwork detail and Approved Document L.

PLAIN GLAZED AND BAR DESIGN OPTIONS

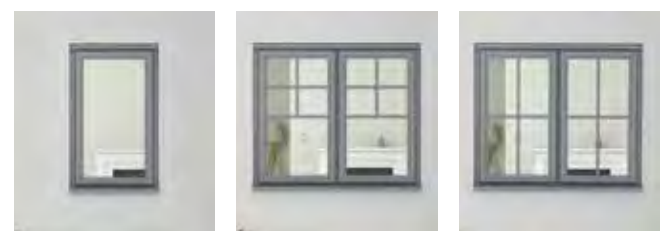

Plain

Victorian Bar

Cottage Bar

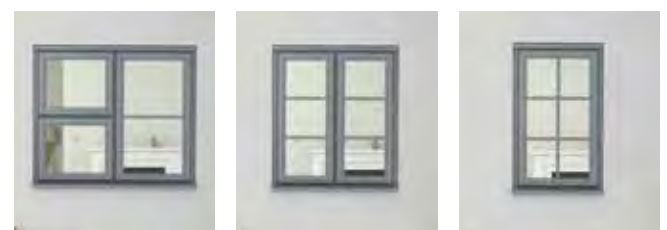

Horizontal Bar

Deco Bar

All Bar



U available down to: 0.8 Wm²K



Fire egress available to assist with compliance of Approved Document B



Background ventilation provided, to assist with compliance of Approved Document F



SECTION DETAILS

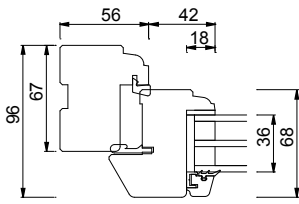
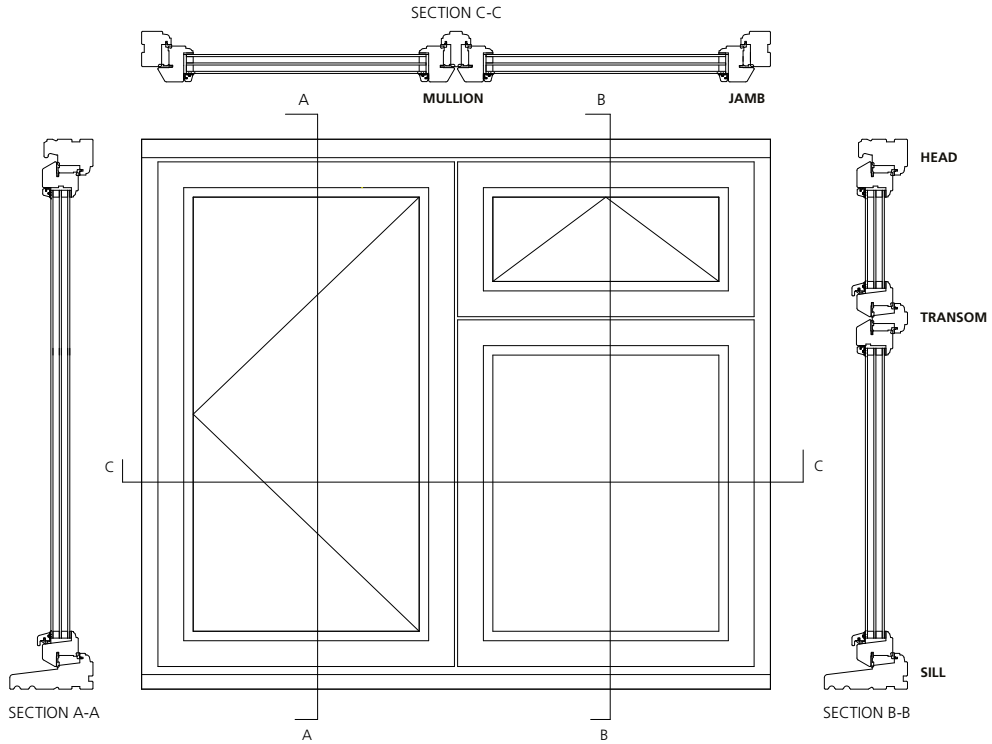

JAMB

TRANSOM

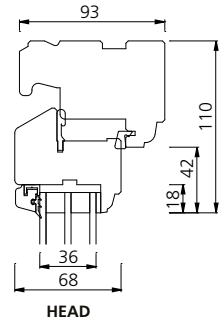
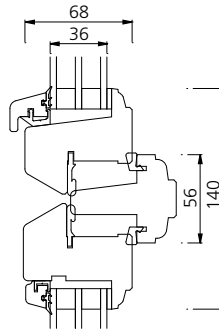

HEAD

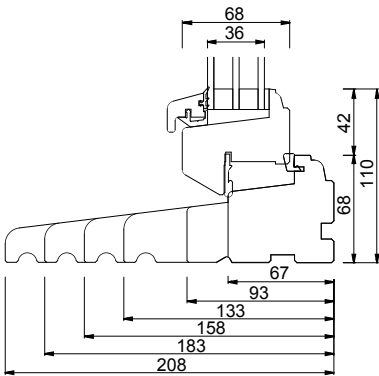

SILL PROJECTION OPTIONS

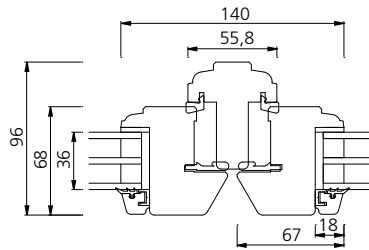

MULLION

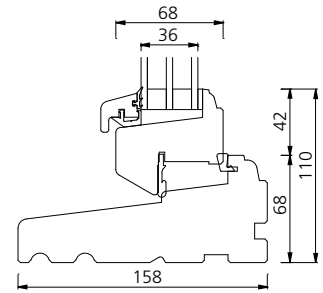

SILL

SIZE LIMITATIONS

Our Stormsure Energy+ casement range is available as standard sizes or made to measure. When specifying made to measure products, the below limitations should be used as a guide to what can be manufactured.

	Min Sash Width (mm)	Min Sash Height (mm)	Max Sash Width (mm)	Max Sash Height (mm)
Side hung	400	400	800	1600
Top hung	400	400	1200	1500

Limitations for projecting hinges

	Min Frame Width (mm)	Min Frame Height (mm)	Max Frame Width (mm)	Max Frame Height (mm)	Max Frame Area (mm ²)
Frame	300	300	3000	2400	2500

Including fixed sash

PAS 24 fixed sash: Max frame width is 1460mm, max frame height is 2350mm.

Please note, configuration limitations vary within the min/max dimensions due to weight and sash proportions.

For further detailed sizing please contact our estimating department on 0845 1222892.

ACOUSTIC PERFORMANCE

External noise reduction is required from various different sources. These can either be road traffic, air traffic, rail or pedestrians. Depending on the different sources, certain frequencies will be relatively higher which results in a significant reduction required for this specific band of frequency. These tables detail these bands, which will enable you to see the exact performance of the product.

Stormsure Energy+ (4-12-4-12-4)

No vents

Freq F HZ	Sound Reduction Index, dB	
	1/3 Octave	1/1 Octave
100	27.9	24.1
125	21	
160	23.4	
200	25	25.9
250	26.8	
315	25.8	
400	30.6	
500	33	33.3
630	36.4	
800	38.8	
1000	41.4	40.9
1250	42.5	
1600	44.2	
2000	44.3	42.4
2500	38.6	
3150	29.1	31.4
4000	30.4	
5000	34.8	

Rating according to BS EN ISO 10140-2:2010
RW (C;Ctr) = 36 (-2;-4) dB

Stormsure Energy+ (4-12-4-10-6.8)

No vents

Freq F HZ	Sound Reduction Index, dB	
	1/3 Octave	1/1 Octave
100	29.3	25.2
125	22.4	
160	23.8	
200	28.7	31.2
250	33.1	
315	31.7	
400	35.9	
500	38.9	38.5
630	40.7	
800	41.8	
1000	41.2	41.2
1250	40.6	
1600	43.2	
2000	43.4	43.4
2500	43.7	
3150	40.8	42.6
4000	42.2	
5000	44.7	

Rating according to BS EN ISO 10140-2:2010
RW (C;Ctr) = 40 (-1;-4) dB

PURGE VENTILATION AND DAYLIGHT AREA FIGURES

Purge ventilation is manually controlled ventilation of rooms or spaces at a relatively high rate to rapidly dilute pollutants and/or water vapour. Purge ventilation may be provided by natural means, eg. by a window that opens, or by mechanical means eg. a fan. For a window that opens 30° or more or for vertical sliding sash windows, the height x width of the opening part should be at least 1/20th of the floor area of the room. The same rule applies to windows opening between 15° - 30°, however the width x height should be at least 1/10th of the floor area. If the window opens less than 15°, then the window is not suitable for purge ventilation and other arrangements should be made. All of our windows when specified as opening will open past 30° unless a permanent restrictor is specified.

Below we provide purge ventilation and daylight figures for our standard sized products. If you require these figures for a made to measure product, then please follow the below calculation using the illustration provided.

Calculation for daylight figures

Width: Overall frame width (mm) minus A's

Height: Overall frame height (mm) minus B's

Width x height = mm² of daylight

Calculation for purge ventilation figures

Width: Overall frame width (mm) minus C's

Height: Overall frame height (mm) minus D's

Width x height = mm² of purge ventilation

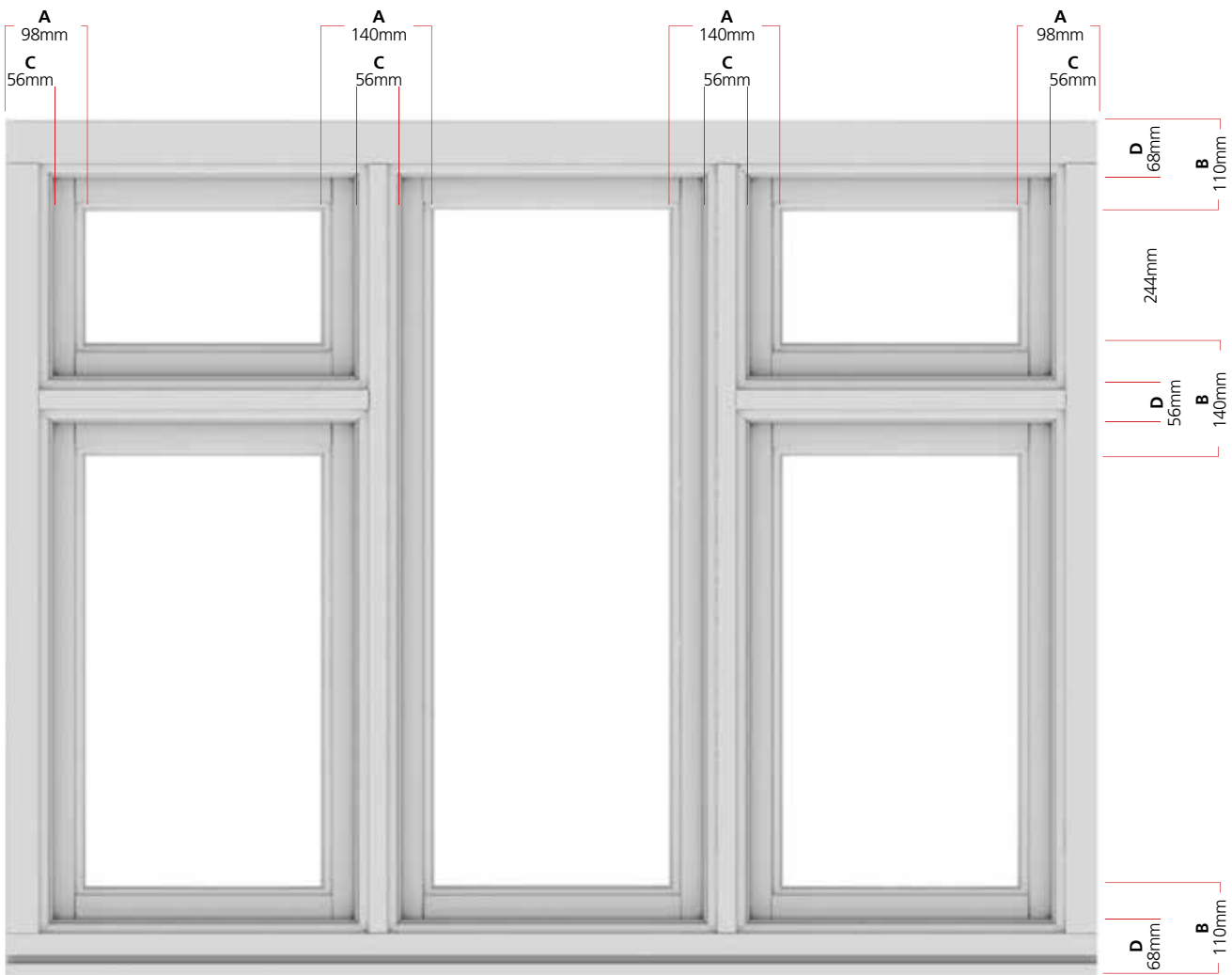

Internal view

STORMSURE ENERGY+ CASEMENT

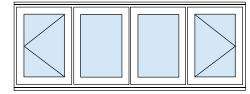
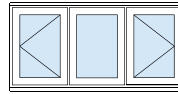
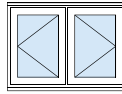
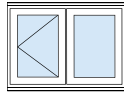

Height	Width 625mm	D mm ²	V mm ²	Width 1195mm	D mm ²	V mm ²	Width 1195mm	D mm ²	V mm ²	Width 1765mm	D mm ²	V mm ²	Width 2334mm	D mm ²	V mm ²
745	SLEWP107C	225225	312417	SLEWP207C	537642	312417	SLEWP207CC	450450	624834	SLEWP307CC	762867	624834	SLEWP407CMC	2404650	1395693
895	SLEWP109C	289575	389367	SLEWP209C	678942	389367	SLEWP209CC	579150	778734	SLEWP309CC	968517	778734	SLEWP409CMC	1357884	778734
1045	SLEWP110C	353925	466317	SLEWP210C	820242	466317	SLEWP210CC	707850	932634	SLEWP310CC	1174167	932634	SLEWP410CMC	1640484	932634
1195	SLEWP112C	418275	543267	SLEWP212C	961542	543267	SLEWP212CC	836550	1086534	SLEWP312CC	1379817	1086534	SLEWP412CMC	1923084	1086534
1345	SLEWP113C	482625	620217	SLEWP213C	1102842	620217	SLEWP213CC	965250	1240434	SLEWP313CC	1585467	1240434	SLEWP413CMC	2205684	1240434
1495	SLEWP115C	546975	697167	SLEWP215C	1148775	697847	SLEWP215CC	1095225	1395693	SLEWP315CC	1750575	1396146	SLEWP415CMC	2404650	1395693

D = Daylight mm² V = Ventilation mm²

STORMSURE ENERGY+ CASEMENT – NARROW MODULE

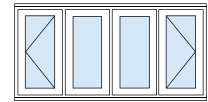
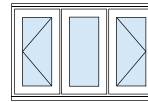
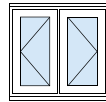
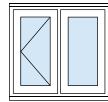
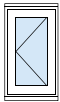

Height	Width 483mm	D mm ²	V mm ²	Width 910mm	D mm ²	V mm ²	Width 910mm	D mm ²	V mm ²	Width 1337mm	D mm ²	V mm ²	Width 1765mm	D mm ²	V mm ²
745	SLEWP07C	150675	228984	SLEWP2N07C	379659	228984	SLEWP2N07CC	301350	457968	SLEWP3N07CC	530334	457968	SLEWP4N07CMC	2404650	1395693
895	SLEWP09C	193725	285384	SLEWP2N09C	479109	285384	SLEWP2N09CC	387450	570768	SLEWP3N09CC	672834	570768	SLEWP4N09CMC	958218	570768
1045	SLEWP10C	236775	341784	SLEWP2N10C	578559	341784	SLEWP2N10CC	473550	683568	SLEWP3N10CC	815334	683568	SLEWP4N10CMC	1157118	683568
1195	SLEWP12C	279825	398184	SLEWP2N12C	678009	398184	SLEWP2N12CC	559650	796368	SLEWP3N12CC	957834	796368	SLEWP4N12CMC	1356018	796368
1345	SLEWP13C	322875	454584	SLEWP2N13C	777459	454584	SLEWP2N13CC	645750	909168	SLEWP3N13CC	1100334	909168	SLEWP4N13CMC	1554918	909168
1495	SLEWP15C	365925	504189	SLEWP2N15C	785400	504189	SLEWP2N15CC	731850	1008378	SLEWP3N15CC	1204875	1008378	SLEWP4N15CMC	2404650	1395693

D = Daylight mm² V = Ventilation mm²

STORMSURE ENERGY+ CASEMENT – NARROW MODULE FIRE ESCAPE

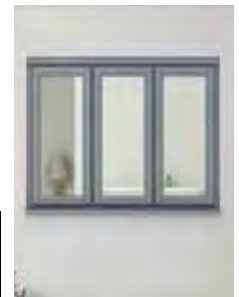
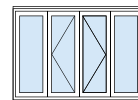
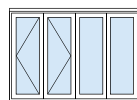
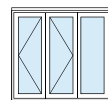
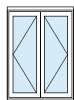

Height	Width 910mm	D mm ²	V mm ²	Width 1337mm	D mm ²	V mm ²	Width 1765mm	D mm ²	V mm ²	Width 1765mm	D mm ²	V mm ²
895	SLEWP2N09FE	2404650	1395693	SLEWP3N09FE	2404650	1395693	SLEWP4N09FE	2404650	1395693	SLEWP4N09FEC	2404650	1395693
1045	SLEWP2N10FE	473550	725382	SLEWP3N10FE	482625	620217	SLEWP4N10FE	482625	620217	SLEWP4N10FEC	482625	620217
1195	SLEWP2N12FE	559650	84508	SLEWP3N12FE	482625	620217	SLEWP4N12FE	482625	620217	SLEWP4N12FEC	482625	620217
1345	SLEWP2N13FE	482625	620217	SLEWP3N13FE	482625	620217	SLEWP4N13FE	482625	620217	SLEWP4N13FEC	482625	620217

D = Daylight mm² V = Ventilation mm²

STORMSURE ENERGY+ CASEMENT – NARROW MODULE WITH VENTS



Height	Width 483mm	D mm ²	V mm ²	Width 910mm	D mm ²	V mm ²
745	SLEWPN07V	162104	91744	SLEWP2N07CV	312779	320728
895	SLEWPN09V	218504	91744	SLEWP2N09CV	412229	377128
1045	SLEWPN10V	274904	91744	SLEWP2N10CV	511679	433528
1195	SLEWPN12V	331304	91744	SLEWP2N12CV	611129	489928

D = Daylight mm² V = Ventilation mm²

STORMSURE ENERGY+ CASEMENT – WITH VENTS

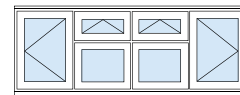
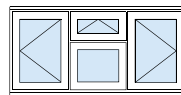
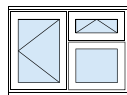
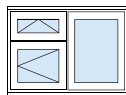

Height	Width 625mm	D mm ²	V mm ²	Width 1195mm	D mm ²	V mm ²	Width 1195mm	D mm ²	V mm ²	Width 1765mm	D mm ²	V mm ²	Width 2334mm	D mm ²	V mm ²
745	SLEWP107V	227157	125172				SLEWP207CV	452382	437589	SLEWP307CVC	720825	750775	SLEWP407CVVC	904764	875178
895	SLEWP109V	304107	125172	SLEWP209T	618882	360639	SLEWP209CV	593682	514539	SLEWP309CVC	883257	903906	SLEWP409CVVC	1187364	1029078
1045	SLEWP110V	381057	125172	SLEWP210T	760182	437589	SLEWP210CV	734982	591489	SLEWP310CVC	1088907	1057806	SLEWP410CVVC	1469964	1182978
1195	SLEWP112V	458007	125172	SLEWP212T	901482	514539	SLEWP212CV	876282	668439	SLEWP312CVC	1294557	1211706	SLEWP412CVVC	1752564	1336878
1345	SLEWP113V	534957	125172	SLEWP213T	1042782	591489	SLEWP213CV	1017582	745389	SLEWP313CVC	1500207	1365606	SLEWP413CVVC	2035164	1499778
1495	SLEWP115V	611907	125172	SLEWP215T	1184082	668439	SLEWP215CV	1148775	841027	SLEWP315CVC	1750575	1551273	SLEWP415CVVC	2297550	1682054

D = Daylight mm² V = Ventilation mm²

STORMSURE ENERGY+ CASEMENT - LANDSCAPE WITH VENTS

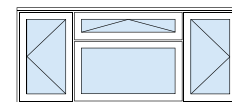
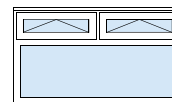
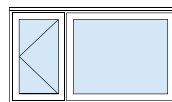
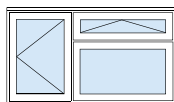
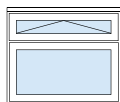
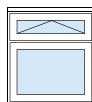

Height	Width 910mm	D mm ²	V mm ²	Width 1195mm	D mm ²	V mm ²	Width 1765mm	D mm ²	V mm ²	Width 1765mm	D mm ²	V mm ²	Width 1765mm	D mm ²	V mm ²	Width 2334mm	D mm ²	V mm ²
895	SLEWP2N09W	480522	194712	SLEWP209W	656937	264252	SLEWP309CW	992925	716930	SLEWP309C	1111572	389367	SLEWP309C	961044	389424	SLEWP409CWC	1236087	1181496
1045	SLEWP2N10W	600222	194712	SLEWP210W	819387	264252	SLEWP310CW	1173312	730569	SLEWP310C	1338372	466317	SLEWP310C	1200444	389424	SLEWP410CWC	1527237	1196886
1195	SLEWP2N12W	719922	194712	SLEWP212W	981837	264252	SLEWP312CW	1400112	807519	SLEWP312C	1565172	543267	SLEWP312C	1439844	389424	SLEWP412CWC	1818387	1350786
1345	SLEWP2N13W	839622	194712	SLEWP213W	1144287	264252	SLEWP313CW	1626912	884469	SLEWP313C	1791972	620217	SLEWP313C	1679244	389424	SLEWP413CWC	2109537	150468
1495	SLEWP2N15W	959322	194712	SLEWP215W	1306737	264252	SLEWP315CW	1875525	1283673	SLEWP315C	1875525	697167	SLEWP315C	1918644	389424	SLEWP415CWC	2400687	1658586

D = Daylight mm² V = Ventilation mm²

STORMSURE ENERGY+ CASEMENT – TOP HUNG WITH SUB LIGHT

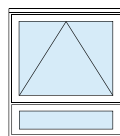
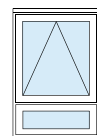
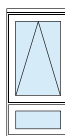

Height	Width 625mm	D mm ²	V mm ²	Width 910mm	D mm ²	V mm ²	Width 1195mm	D mm ²	V mm ²
1345	SLEWP113AS	479097	466317	SLEWP2N13AS	783762	725382	SLEWP213AS	1088427	984447
1495	SLEWP115AS	576792	543267	SLEWP2N15AS	942732	845082	SLEWP215AS	1308672	1146897

D = Daylight mm² V = Ventilation mm²

STORMSURE ENERGY+ CASEMENT - FIXED SASH

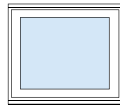
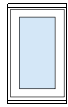

Height	Width 625mm	D mm ²	V mm ²	Width 1195mm	D mm ²	V mm ²
445	SLEWP104DG	158517	0	SLEWP204DG	334647	0
595	SLEWP106DG	235467	0	SLEWP206DG	497097	0
745	SLEWP107DG	312417	0	SLEWP207DG	659547	0
895	SLEWP109DG	389367	0	SLEWP209DG	821997	0
1045	SLEWP110DG	466317	0	SLEWP210DG	984447	0
1195	SLEWP112DG	543267	0	SLEWP212DG	1146897	0
1345	SLEWP113DG	620217	0	SLEWP213DG	1309347	0

D = Daylight mm² V = Ventilation mm²

STORMSURE ENERGY+ CASEMENT - TRANSOM WITH VENTS

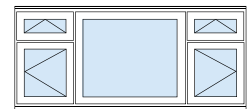
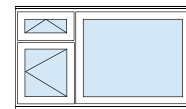
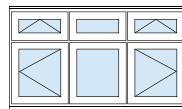
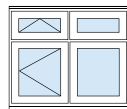
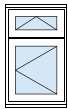

Height	Width 625mm	D mm ²	V mm ²	Width 1195mm	D mm ²	V mm ²	Width 1765mm	D mm ²	V mm ²	Width 1765mm	D mm ²	V mm ²	Width 2334mm	D mm ²	V mm ²
895	SLEWP109T	229515	360639	SLEWP209TX	590154	360639	SLEWP309TXT	1132839	721278	SLEWP309T	1051512	360639	SLEWP409TT	1307808	721278
1045	SLEWP110T	293865	437589	SLEWP210TX	731454	437589	SLEWP310TXT	1338489	875178	SLEWP310T	1278312	437589	SLEWP410TT	1547208	875178
1195	SLEWP112T	358215	514539	SLEWP212TX	872754	514539	SLEWP312TXT	1544139	1029078	SLEWP312T	1505112	514539	SLEWP412TT	1786608	1029078
1345	SLEWP113T	422565	591489	SLEWP213TX	1014054	591489	SLEWP313TXT	1749789	1182978	SLEWP313T	1731912	591489	SLEWP413TT	2026008	1182978
1495	SLEWP115T	486915	668439	SLEWP215TX	1155354	668439	SLEWP315TXT	1955439	1336878	SLEWP315T	1958712	668439	SLEWP415TT	2265408	1336878

D = Daylight mm² V = Ventilation mm²

STORMSURE ENERGY+ CASEMENT – TOP HUNG

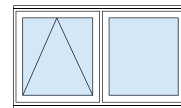
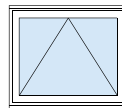
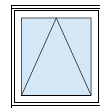
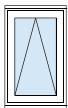

Height	Width 625mm	D mm ²	V mm ²	Width 910mm	D mm ²	V mm ²	Width 1195mm	D mm ²	V mm ²	Width 1765mm	D mm ²	V mm ²
445	SLEWP104A	96525	158517	SLEWP2N04A	160650	246582	SLEWP204A	224775	334647	SLEWP304AE	407232	246582
595	SLEWP106A	160875	235467	SLEWP2N06A	267750	366282	SLEWP206A	374625	497097	SLEWP306AE	634032	366282
745	SLEWP107A	225225	312417	SLEWP2N07A	374850	485982	SLEWP207A	524475	659547	SLEWP307AE	860832	485982
895	SLEWP109A	289575	389367	SLEWP2N09A	481950	605682	SLEWP209A	674325	821997	SLEWP309AE	1087632	605682
1045	SLEWP110A	353925	466317	SLEWP2N10A	589050	725382	SLEWP210A	824175	984447	SLEWP310AE	1313342	725382
1195	SLEWP112A	418275	543267	SLEWP2N12A	696150	845082	SLEWP212A	974025	1146897	SLEWP312AE	1541232	845082

D = Daylight mm² V = Ventilation mm²

STORMSURE STANDARD CASEMENT



Our most popular timber windows are available in a large range of standard sizes or made to measure to suit your project requirements.

- U values available 1.3-1.4 W/m²K, BFRC energy rated A-B
- Sash depth 55mm
- Double glazed with warm edge black spacer bar as standard, white and grey optional
- **Softwood and oak timber available in all standard casement frames excluding Regency**
- Design options – Standard, Victorian Bar, Horizontal Bar, All Bar, Cottage Bar, Deco Bar, Regency and Designer available
- Hardex polished chrome handles as standard. Other options available see page 156 for more hardware information
- Espagnolette multi-point locking and projecting hinges as standard. Fire egress projecting hinge option available where indicated
- Non-opening areas are direct glazed as standard, fixed sashes are available
- **Softwood:** Factory finished in Hi-Build white paint as standard, other RAL colour options available – see page 152 for finishing details
- **Oak:** Factory finished golden oak stained as standard, dark oak stain optional
- Standard, made to measure and imperial sizes available. CAD drawings are available on our website
- Approved Document M - low level handles and cord operated ventilators are available as an optional extra
- Factory glazed windows are CE Marked, see page 26 for glazing options
- FSC certified, Chain of Custody on request
- RIBA timber window CPD seminar available, book online
- PAS 24 specification options available to meet the requirements of Approved Document Q and Secured by Design
- For full specification details see page 24





Glazing

Using glazing rebates of 18mm x 42mm, Stormsure windows will accept 24mm (4:16:4) insulating glass units as standard. The Stormsure range incorporates 18mm x 55mm glazing rebates, accepting a 36mm (4:12:4:12:4) insulating glass units. The glazing system is fully drained and vented with a sloping bottom platform. A full 5mm clearance is provided between the insulating glass unit and rebate, in compliance with BS 6262.

Ventilation

Flush fitting ventilators are supplied fitted as standard to all Stormsure windows to assist in compliance with Approved Document F of the Building Regulations. These provide an Equivalent Area of 6100mm² on windows 915mm and wider, 3050mm² on windows below that size, down to 488mm² wide. This product is also available with no trickle ventilation at time of order.



dB reductions up to: 37dB



U available down to: 0.8 W/m²K



Fire egress available to assist with compliance of Approved Document B



Background ventilation provided, to assist with compliance of Approved Document F



Sill Detail

A narrow 93mm stub sill is available as well as extended sills to widths of 208mm. Care must be taken to ensure that the correct sill width is specified to suit the brickwork detail and Approved Document L.

PLAIN GLAZED AND BAR DESIGN OPTIONS



Plain



Victorian Bar



Cottage Bar



Horizontal Bar



Deco Bar



All Bar

SECTION DETAILS

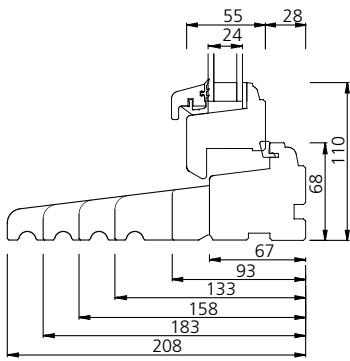
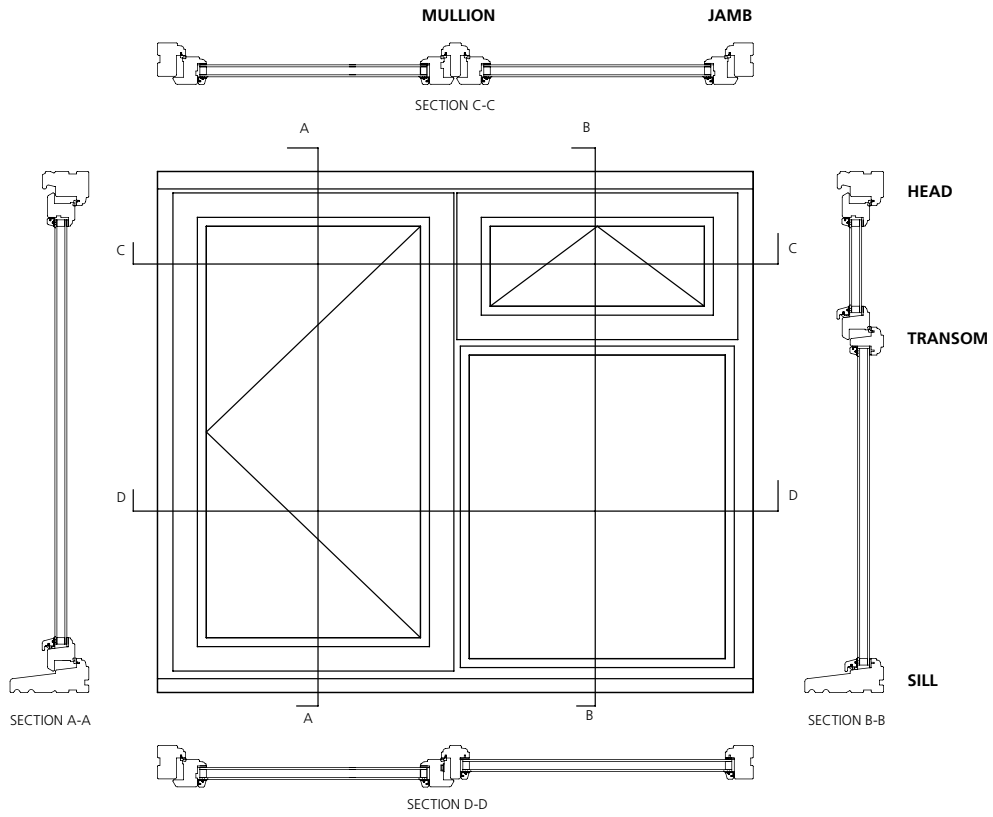

SILL PROJECTION OPTIONS

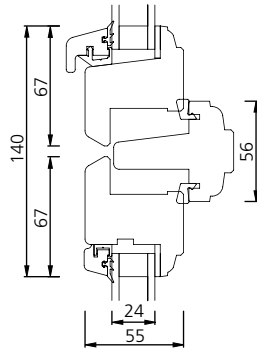

TRANSOM

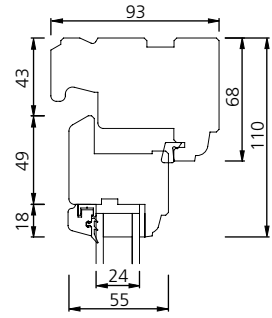

HEAD

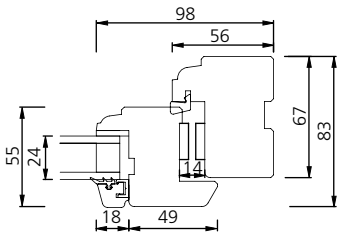

JAMB

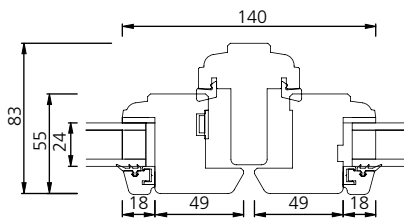

MULLION

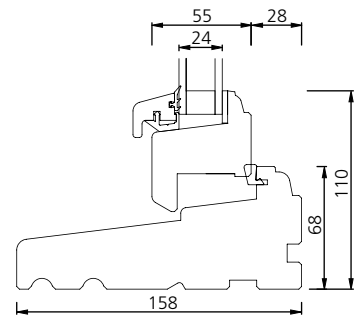

SILL

SIZE LIMITATIONS

Our Stormsure casement range is available as standard sizes or made to measure. When specifying made to measure products, the below limitations should be used as a guide to what can be manufactured.

	Min Sash Width (mm)	Min Sash Height (mm)	Max Sash Width (mm)	Max Sash Height (mm)
Side hung	400	400	800	1600
Top hung	400	400	1200	1480

Limitations for projecting hinges

	Min Frame Width (mm)	Min Frame Height (mm)	Max Frame Width (mm)	Max Frame Height (mm)	Max Frame Area (mm ²)
Frame	300	300	3000	2400	2500

Including direct glazed and fixed sash

PAS 24 fixed sash: Max frame width is 1460mm, max frame height is 2350mm.

Please note, configuration limitations vary within the min/max dimensions due to weight and sash proportions.

For further detailed sizing please contact our estimating department on 0845 1222892.



ACOUSTIC PERFORMANCE

External noise reduction is required from various different sources. These can either be road traffic, air traffic, rail or pedestrians. Depending on the different sources, certain frequencies will be relatively higher which results in a significant reduction required for this specific band of frequency. These tables detail these bands, which will enable you to see the exact performance of the product.

Stormsure (4F-16-4F)
Titon trickle vent blanked off

Freq F HZ	Sound Reduction Index, dB	
	1/3 Octave	1/1 Octave
100	22.6	22.2
125	21.9	
160	22.1	
200	14.9	19.0
250	24.0	
315	31.1	
400	32.2	33.3
500	33.4	
630	34.6	
800	34.5	35.7
1000	34.5	
1250	37.7	
1600	39.4	39.9
2000	41.2	
2500	39.2	
3150	36.5	38.0
4000	37.9	
5000	40.4	

Rating according to BS EN ISO 717-1:1997
RW (C;Ctr) = 35 (-3;-7) dB

Stormsure (4F-16-4F)
Titon trickle vent open

Freq F HZ	Sound Reduction Index, dB	
	1/3 Octave	1/1 Octave
100	19.3	18.8
125	18.5	
160	18.5	
200	14.1	17.7
250	21.0	
315	24.2	
400	24.8	24.4
500	24.6	
630	23.8	
800	21.3	20.8
1000	20.1	
1250	20.9	
1600	19.4	20.5
2000	21.1	
2500	21.2	
3150	20.2	21.4
4000	21.8	
5000	22.6	

Rating according to BS EN ISO 717-1:1997
RW (C;Ctr) = 21 (0;0) dB

Stormsure (4F-16-4F)
Titon trickle vent closed

Freq F HZ	Sound Reduction Index, dB	
	1/3 Octave	1/1 Octave
100	21.6	20.8
125	20.2	
160	20.6	
200	14.7	18.7
250	23.0	
315	28.4	
400	28.2	27.7
500	28.0	
630	27.0	
800	24.1	25.3
1000	24.7	
1250	27.7	
1600	29.4	30.2
2000	33.4	
2500	29.0	
3150	30.5	31.9
4000	32.4	
5000	33.5	

Rating according to BS EN ISO 717-1:1997
RW (C;Ctr) = 28 (-1;-3) dB

Stormsure (4F-16-4F)
Glidevale trickle vent closed

Freq F HZ	Sound Reduction Index, dB	
	1/3 Octave	1/1 Octave
100	20.1	19.9
125	19.1	
160	20.6	
200	14.1	18.1
250	23.0	
315	27.2	
400	26.9	27.0
500	27.1	
630	26.9	
800	22.4	21.8
1000	20.7	
1250	22.4	
1600	23.9	25.6
2000	26.4	
2500	27.1	
3150	28.8	30.3
4000	30.7	
5000	32.1	

Rating according to BS EN ISO 717-1:1997
RW (C;Ctr) = 25 (-1;-2) dB

Stormsure (4F-16-6.4L)
Vents blanked off

Freq F HZ	Sound Reduction Index, dB	
	1/3 Octave	1/1 Octave
100	23.1	23.3
125	22.2	
160	25.0	
200	22.4	26.0
250	28.6	
315	33.1	
400	33.8	35.1
500	35.3	
630	36.5	
800	35.4	36.4
1000	35.8	
1250	38.6	
1600	39.8	40.0
2000	40.5	
2500	39.9	
3150	40.7	41.6
4000	41.2	
5000	43.5	

Rating according to BS EN ISO 717-1:1997
RW (C;Ctr) = 37 (-1;-4) dB

Stormsure (4F-16-4F)
Titon select hood vent open

Freq F HZ	Sound Reduction Index, dB	
	1/3 Octave	1/1 Octave
100	17.5	17.7
125	17.9	
160	17.8	
200	13.5	17.2
250	21.0	
315	23.4	
400	24.1	24.4
500	23.8	
630	25.6	
800	23.1	20.5
1000	20.8	
1250	18.7	
1600	19.2	19.7
2000	19.9	
2500	20.1	
3150	19.5	20.4
4000	20.6	
5000	21.2	

Rating according to BS EN ISO 717-1:1997
RW (C;Ctr) = 21 (-1;-1) dB

Stormsure (4F-16-4F)

Vents blanked off

Freq F HZ	Sound Reduction Index, dB	
	1/3 Octave	1/1 Octave
100	22.1	23.0
125	22.3	
160	25.2	
200	22.4	25.8
250	28.1	
315	32.3	
400	32.8	33.8
500	34.1	
630	34.8	
800	33.6	33.6
1000	33.7	
1250	33.4	
1600	34.0	36.4
2000	38.0	
2500	38.8	
3150	39.3	39.3
4000	39.4	
5000	39.3	

Rating according to BS EN ISO 717-1:1997

RW (C;Ctr) = 35 (-1;-3) dB

Stormsure with 4-14-6.8PVB glass

Vents removed and blocked

Freq F HZ	Sound Reduction Index, dB	
	1/3 Octave	1/1 Octave
50+	17.7	19.6
63+	20.3	
80+	22.2	
100	19.7	21.9
125	24.7	
160	23.0	
200	20.9	24.6
250	27.2	
315	33.6	
400	32.6	34.5
500	35.6	
630	36.2	
800	36.0	36.4
1000	35.6	
1250	38.0	
1600	41.4	41.6
2000	42.3	
2500	41.3	
3150	39.3	39.5
4000	39.0	
5000	40.4	
6300+	45.3	47.6
8000+	48.1	
1000+	51.4	
Average 100-3150		33.0

Rating according to BS EN ISO 717-1:1997

RW (C;Ctr) = 37 (-2;-5) dB

Stormsure with 4-14-6.8PVB glass

2 x Titon R16-4000 vents closed

Freq F HZ	Sound Reduction Index, dB	
	1/3 Octave	1/1 Octave
50+	17.5	19.5
63+	20.4	
80+	21.9	
100	17.8	20.3
125	23.6	
160	21.4	
200	20.3	23.6
250	26.0	
315	29.3	
400	29.4	28.4
500	28.7	
630	27.4	
800	24.6	23.9
1000	23.3	
1250	24.0	
1600	27.7	29.2
2000	31.3	
2500	29.2	
3150	30.7	31.9
4000	32.2	
5000	33.0	
6300+	36.9	39.1
8000+	39.4	
1000+	42.8	
Average 100-3150		25.9

Rating according to BS EN ISO 717-1:1997

RW (C;Ctr) = 28 (-1;-3) dB

Stormsure with 4-14-6.8PVB glass

2 x Titon R16-4000 vents open

Freq F HZ	Sound Reduction Index, dB	
	1/3 Octave	1/1 Octave
50+	16.4	17.0
63+	18.4	
80+	20.0	
100	14.9	16.9
125	20.9	
160	16.7	
200	17.0	19.9
250	21.9	
315	23.7	
400	24.4	23.7
500	23.6	
630	23.3	
800	21.3	19.7
1000	20.6	
1250	18.0	
1600	15.9	17.0
2000	16.9	
2500	18.5	
3150	17.2	18.7
4000	19.1	
5000	20.5	
6300+	22.7	25.1
8000+	25.3	
1000+	30.4	
Average 100-3150		19.7

Rating according to BS EN ISO 717-1:1997

RW (C;Ctr) = 19 (-1;-0) dB

PURGE VENTILATION AND DAYLIGHT AREA FIGURES

Purge ventilation is manually controlled ventilation of rooms or spaces at a relatively high rate to rapidly dilute pollutants and/or water vapour. Purge ventilation may be provided by natural means, eg. by a window that opens, or by mechanical means eg. a fan. For a window that opens 30° or more or for vertical sliding sash windows, the height x width of the opening part should be at least 1/20th of the floor area of the room. The same rule applies to windows opening between 15° - 30°, however the width x height should be at least 1/10th of the floor area. If the window opens less than 15°, then the window is not suitable for purge ventilation and other arrangements should be made. All of our windows when specified as opening will open past 30° unless a permanent restrictor is specified.

Below we provide purge ventilation and daylight figures for our standard sized products. If you require these figures for a made to measure product, then please follow the below calculation using the illustration provided.

Calculation for daylight figures

Width: Overall frame width (mm) minus A's

Height: Overall frame height (mm) minus B's

Width x height = mm² of daylight

Calculation for purge ventilation figures

Width: Overall frame width (mm) minus C's

Height: Overall frame height (mm) minus D's

Width x height = mm² of purge ventilation

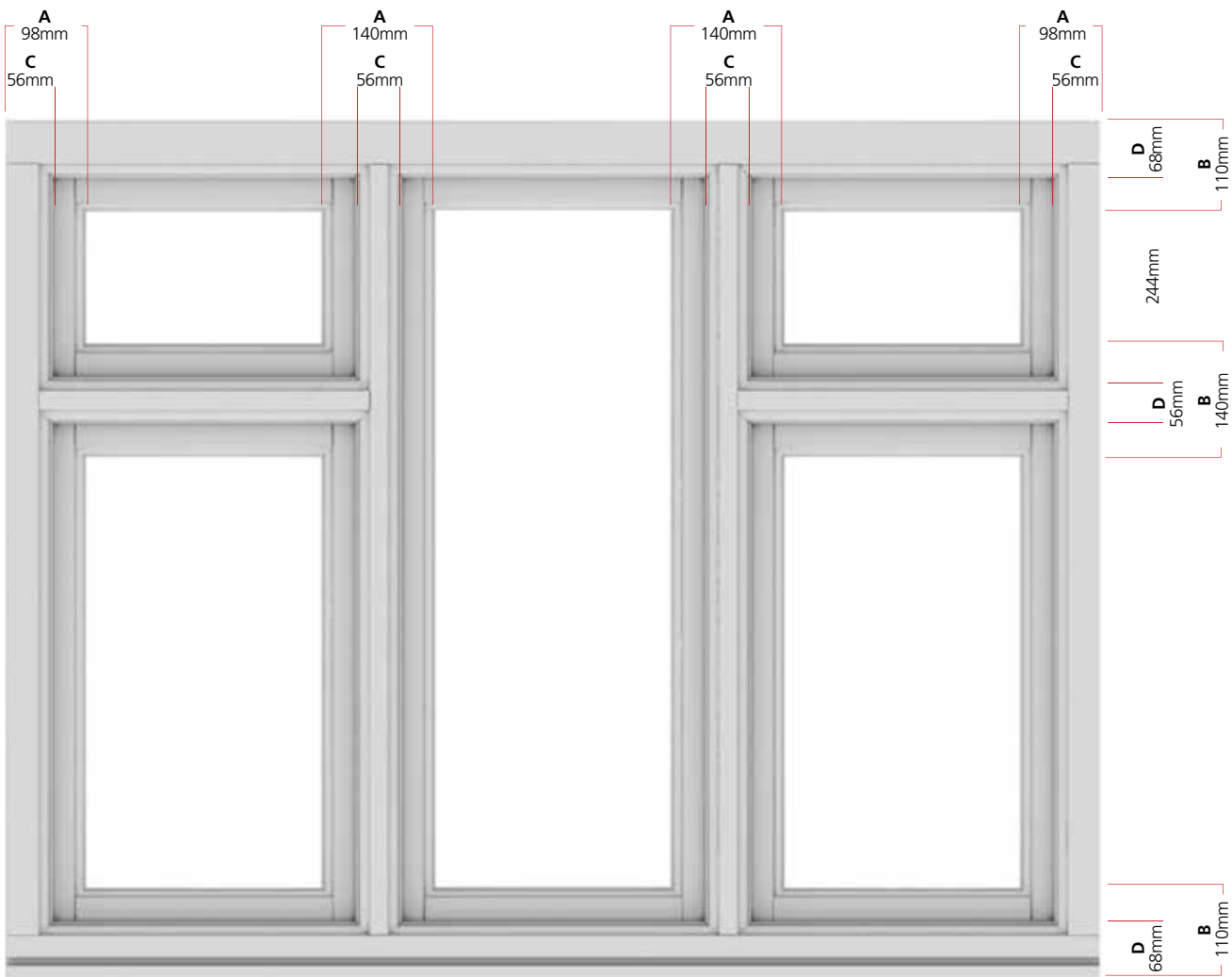

Internal view

STANDARD CASEMENT

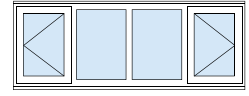
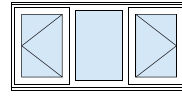
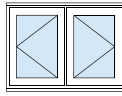
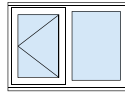

Height	Width 625mm	D mm ²	V mm ²	Width 1195mm	D mm ²	V mm ²	Width 1195mm	D mm ²	V mm ²	Width 1765mm	D mm ²	V mm ²	Width 2334mm	D mm ²	V mm ²
745	SLEW107C	225225	312417	SLEW207C	537642	312417	SLEW207CC	450450	624834	SLEW307CC	762867	624834	SLEW407CMC	2404650	1395693
895	SLEW109C	289575	389367	SLEW209C	678942	389367	SLEW209CC	579150	778734	SLEW309CC	968517	778734	SLEW409CMC	1357884	778734
1045	SLEW110C	353925	466317	SLEW210C-A	820242	466317	SLEW210CC	707850	932634	SLEW310CC	1174167	932634	SLEW410CMC	1640484	932634
1195	SLEW112C	418275	543267	SLEW212C	961542	543267	SLEW212CC	836550	1086534	SLEW312CC	1379817	1086534	SLEW412CMC	1923084	1086534
1345	SLEW113C	482625	620217	SLEW213C	1102842	620217	SLEW213CC	965250	1240434	SLEW313CC	1585467	1240434	SLEW413CMC	2205684	1240434
1495	SLEW115C	546975	697167	SLEW215C	1148775	697847	SLEW215CC	1095225	1395693	SLEW315CC	1750575	1396146	SLEW415CMC	2404650	1395693

D = Daylight mm² V = Ventilation mm²

STANDARD CASEMENT – NARROW MODULE

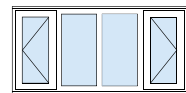
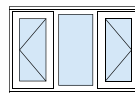

Height	Width 483mm	D mm ²	V mm ²	Width 910mm	D mm ²	V mm ²	Width 910mm	D mm ²	V mm ²	Width 1337mm	D mm ²	V mm ²	Width 1765mm	D mm ²	V mm ²
745	SLEWN07C	150675	228984	SLEW2N07C	379659	228984	SLEW2N07CC	301350	457968	SLEW3N07CC	530334	457968	SLEW4N07CMC	2404650	1395693
895	SLEWN09C	193725	285384	SLEW2N09C	479109	285384	SLEW2N09CC	387450	570768	SLEW3N09CC	672834	570768	SLEW4N09CMC	958218	570768
1045	SLEWN10C	236775	341784	SLEW2N10C	578559	341784	SLEW2N10CC	473550	683568	SLEW3N10CC	815334	683568	SLEW4N10CMC	1157118	683568
1195	SLEWN12C	279825	398184	SLEW2N12C	678009	398184	SLEW2N12CC	559650	796368	SLEW3N12CC	957834	796368	SLEW4N12CMC	1356018	796368
1345	SLEWN13C	322875	454584	SLEW2N13C	777459	454584	SLEW2N13CC	645750	909168	SLEW3N13CC	1100334	909168	SLEW4N13CMC	1554918	909168
1495	SLEWN15C	365925	504189	SLEW2N15C	785400	504189	SLEW2N15CC	731850	1008378	SLEW3N15CC	1204875	1008378	SLEW4N15CMC	2404650	1395693

D = Daylight mm² V = Ventilation mm²

STANDARD CASEMENT – NARROW MODULE FIRE ESCAPE

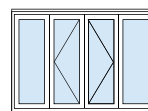
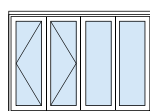
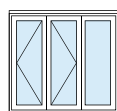
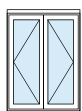

Height	Width 910mm	D mm ²	V mm ²	Width 1337mm	D mm ²	V mm ²	Width 1765mm	D mm ²	V mm ²	Width 1765mm	D mm ²	V mm ²
895	SLEW2N09FE	2404650	1395693	SLEW3N09FE	2404650	1395693	SLEW4N09FE	2404650	1395693	SLEW4N09FEC	2404650	1395693
1045	SLEW2N10FE	473550	725382	SLEW3N10FE	482625	620217	SLEW4N10FE	482625	620217	SLEW4N10FEC	482625	620217
1195	SLEW2N12FE	559650	84508	SLEW3N12FE	482625	620217	SLEW4N12FE	482625	620217	SLEW4N12FEC	482625	620217
1345	SLEW2N13FE	482625	620217	SLEW3N13FE	482625	620217	SLEW4N13FE	482625	620217	SLEW4N13FEC	482625	620217

D = Daylight mm² V = Ventilation mm²



All codes listed in this section refer to fully finished windows.
For Stormsure Oak codes please refer to the JELD-WEN catalogue

STANDARD CASEMENT – NARROW MODULE WITH VENTS



Height	Width 483mm	D mm ²	V mm ²	Width 910mm	D mm ²	V mm ²
745	SLEWN07V	162104	91744	SLEW2N07CV	312779	320728
895	SLEWN09V	218504	91744	SLEW2N09CV	412229	377128
1045	SLEWN10V	274904	91744	SLEW2N10CV	511679	433528
1195	SLEWN12V	331304	91744	SLEW2N12CV	611129	489928

D = Daylight mm² V = Ventilation mm²

STANDARD CASEMENT – WITH VENTS

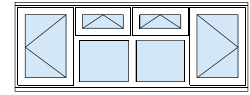
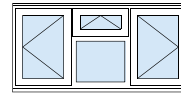
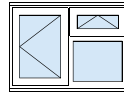
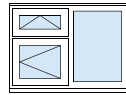

Height	Width 625mm	D mm ²	V mm ²	Width 1195mm	D mm ²	V mm ²	Width 1195mm	D mm ²	V mm ²	Width 1765mm	D mm ²	V mm ²	Width 2334mm	D mm ²	V mm ²
745	SLEW107V	227157	125172	SLEW207T	473025	283966	SLEW207CV	452382	437589	SLEW307CVC	720825	750775	SLEW407CVVC	904764	875178
895	SLEW109V	304107	125172	SLEW209T	618882	360639	SLEW209CV	593682	514539	SLEW309CVC	883257	903906	SLEW409CVVC	1187364	1029078
1045	SLEW110V	381057	125172	SLEW210T	760182	437589	SLEW210CV	734982	591489	SLEW310CVC	1088907	1057806	SLEW410CVVC	1469964	1182978
1195	SLEW112V	458007	125172	SLEW212T	901482	514539	SLEW212CV	876282	668439	SLEW312CVC	1294557	1211706	SLEW412CVVC	1752564	1336878
1345	SLEW113V	534957	125172	SLEW213T	1042782	591489	SLEW213CV	1017582	745389	SLEW313CVC	1500207	1365606	SLEW413CVVC	2035164	1499778
1495	SLEW115V	611907	125172	SLEW215T	1184082	668439	SLEW215CV	1148775	841027	SLEW315CVC	1750575	1551273	SLEW415CVVC	2297550	1682054

D = Daylight mm² V = Ventilation mm²

STANDARD CASEMENT – LANDSCAPE WITH VENTS

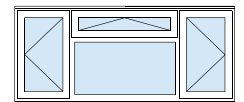
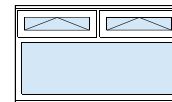
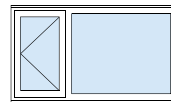
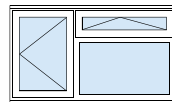
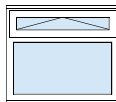
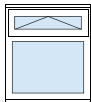

Height	Width 910mm	D mm ²	V mm ²	Width 1195mm	D mm ²	V mm ²	Width 1765mm	D mm ²	V mm ²	Width 1765mm	D mm ²	V mm ²	Width 1765mm	D mm ²	V mm ²	Width 2334mm	D mm ²	V mm ²
895	SLEW2N09W	480522	194712	SLEW209W	656937	264252	SLEW309CW	992925	716930	SLEW309C	1111572	389367	SLEW309WW	961044	389424	SLEW409CWC	1236087	1181496
1045	SLEW2N10W	600222	194712	SLEW210W	819387	264252	SLEW310CW	1173312	730569	SLEW310C	1338372	466317	SLEW310WW	1200444	389424	SLEW410CWC	1527237	1196886
1195	SLEW2N12W	719922	194712	SLEW212W	981837	264252	SLEW312CW	1400112	807519	SLEW312C	1565172	543267	SLEW312WW	1439844	389424	SLEW412CWC	1818387	1350786
1345	SLEW2N13W	839622	194712	SLEW213W	1144287	264252	SLEW313CW	1626912	884469	SLEW313C	1791972	620217	SLEW313WW	1679244	389424	SLEW413CWC	2109537	150468
1495	SLEW2N15W	959322	194712	SLEW215W	1306737	264252	SLEW315CW	1875525	1283673	SLEW315C	1875525	697167	SLEW315WW	1918644	389424	SLEW415CWC	2400687	1658586

D = Daylight mm² V = Ventilation mm²

STANDARD CASEMENT – TOP HUNG WITH SUB LIGHT

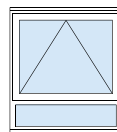
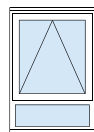
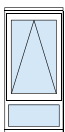

Height	Width 625mm	D mm ²	V mm ²	Width 910mm	D mm ²	V mm ²	Width 1195mm	D mm ²	V mm ²
1345	SLEW113AS	479097	466317	SLEW2N13AS	783762	725382	SLEW213AS	1088427	984447
1495	SLEW115AS	576792	543267	SLEW2N15AS	942732	845082	SLEW215AS	1308672	1146897

D = Daylight mm² V = Ventilation mm²

STANDARD CASEMENT - DIRECT GLAZED

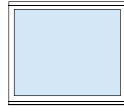
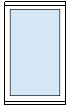

Height	Width 625mm	D mm ²	V mm ²	Width 1195mm	D mm ²	V mm ²
445	SLEW104DG	158517	0	SLEW204DG	334647	0
595	SLEW106DG	235467	0	SLEW206DG	497097	0
745	SLEW107DG	312417	0	SLEW207DG	659547	0
895	SLEW109DG	389367	0	SLEW209DG	821997	0
1045	SLEW110DG	466317	0	SLEW210DG	984447	0
1195	SLEW112DG	543267	0	SLEW212DG	1146897	0
1345	SLEW113DG	620217	0	SLEW213DG	1309347	0

D = Daylight mm² V = Ventilation mm²

STANDARD CASEMENT – TRANSOM WITH VENTS

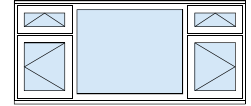
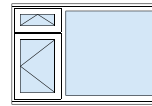
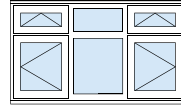
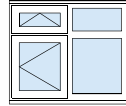
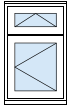

Height	Width 625mm	D mm ²	V mm ²	Width 1195mm	D mm ²	V mm ²	Width 1765mm	D mm ²	V mm ²	Width 1765mm	D mm ²	V mm ²	Width 2334mm	D mm ²	V mm ²
895	SLEW109T	229515	360639	SLEW209TX	590154	360639	SLEW309TXT	1132839	721278	SLEW309T	1051512	360639	SLEW409TT	1307808	721278
1045	SLEW110T	293865	437589	SLEW210TX	731454	437589	SLEW310TXT	1338489	875178	SLEW310T	1278312	437589	SLEW410TT	1547208	875178
1195	SLEW112T	358215	514539	SLEW212TX	872754	514539	SLEW312TXT	1544139	1029078	SLEW312T	1505112	514539	SLEW412TT	1786608	1029078
1345	SLEW113T	422565	591489	SLEW213TX	1014054	591489	SLEW313TXT	1749789	1182978	SLEW313T	1731912	591489	SLEW413TT	2026008	1182978
1495	SLEW115T	486915	668439	SLEW215TX	1155354	668439	SLEW315TXT	1955439	1336878	SLEW315T	1958712	668439	SLEW415TT	2265408	1336878

D = Daylight mm² V = Ventilation mm²

STANDARD CASEMENT – TOP HUNG WITH VENTS

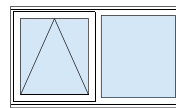
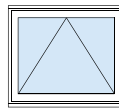
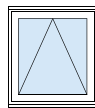
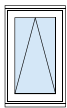

Height	Width 625mm	D mm ²	V mm ²	Width 910mm	D mm ²	V mm ²	Width 1195mm	D mm ²	V mm ²	Width 1765mm	D mm ²	V mm ²
445	SLEW104A	96525	158517	SLEW2N04A	160650	246582	SLEW204A	224775	334647	SLEW304AE	407232	246582
595	SLEW106A	160875	235467	SLEW2N06A	267750	366282	SLEW206A	374625	497097	SLEW306AE	634032	366282
745	SLEW107A	225225	312417	SLEW2N07A	374850	485982	SLEW207A	524475	659547	SLEW307AE	860832	485982
895	SLEW109A	289575	389367	SLEW2N09A	481950	605682	SLEW209A	674325	821997	SLEW309AE	1087632	605682
1045	SLEW110A	353925	466317	SLEW2N10A	589050	725382	SLEW210A	824175	984447	SLEW310AE	1313342	725382
1195	SLEW112A	418275	543267	SLEW2N12A	696150	845082	SLEW212A	974025	1146897	SLEW312AE	1541232	845082

D = Daylight mm² V = Ventilation mm²

All codes listed in this section refer to fully finished windows.
For Stormsure Oak codes please refer to the JELD-WEN catalogue



COTTAGE BAR

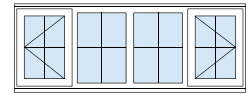
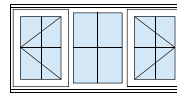
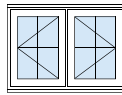
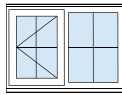

Height	Width 625mm	D mm ²	V mm ²	Width 1195mm	D mm ²	V mm ²	Width 1195mm	D mm ²	V mm ²	Width 1765mm	D mm ²	V mm ²	Width 2334mm	D mm ²	V mm ²
895	SLEWC109CSDL	268960	389367	SLEWC209CSDL	592975	389367	SLEWC209CCSDL	537920	778734	SLEWC309CCSDL	841320	778734	SLEWC409CMCSDL	898720	624834
1045	SLEWC110CSDL	330460	466317	SLEWC210CSDL	718825	466317	SLEWC210CCSDL	660920	932634	SLEWC310CCSDL	1025820	932634	SLEWC410CMCSDL	1144720	78734
1195	SLEWC112CSDL	391960	543267	SLEWC212CSDL	844675	543267	SLEWC212CCSDL	783920	1086534	SLEWC312CCSDL	1210320	1086534	SLEWC412CMCSDL	1390720	932634
1345	SLEWC113CSDL	453460	620217	SLEWC213CSDL	970525	620217	SLEWC213CCSDL	906920	1240434	SLEWC313CCSDL	1394820	1240434	SLEWC413CMCSDL	1636720	1086534

D = Daylight mm² V = Ventilation mm²

COTTAGE BAR – DIVIDED CASEMENT

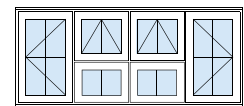
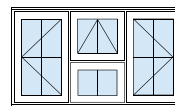
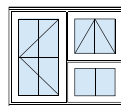
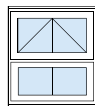
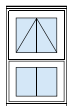

Height	Width 625mm	D mm ²	V mm ²	Width 1195mm	D mm ²	V mm ²	Width 1195mm	D mm ²	V mm ²	Width 1765mm	D mm ²	V mm ²	Width 2334mm	D mm ²	V mm ²
895	SLEWC109DSDL	219350	180319.5	SLEWC209DSDL	371825	280489	SLEWC209CDCSDL	524300	380674.5	SLEWC309CDCSDL	743650	560994	SLEWC409CDDCSDL	1048600	761349
1045	SLEWC110DSDL	280850	218794.5	SLEWC210DSDL	476075	340347	SLEWC210CDCSDL	671300	461899.5	SLEWC310CDCSDL	952150	680694	SLEWC410CDDCSDL	1342600	923799
1195	SLEWC112DSDL	342350	257269.5	SLEWC212DSDL	580325	400197	SLEWC212CDCSDL	818300	543124.5	SLEWC312CDCSDL	1160650	800394	SLEWC412CDDCSDL	1636600	1086249
1345	SLEWC113DSDL	403850	295744.5	SLEWC213DSDL	684575	460047	SLEWC213CDCSDL	965300	624349.5	SLEWC313CDCSDL	1369150	920094	SLEWC413CDDCSDL	1930600	1248699

D = Daylight mm² V = Ventilation mm²

HORIZONTAL BAR

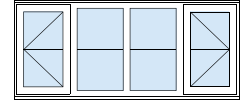
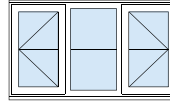
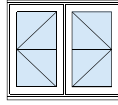
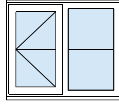
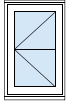

Height	Width 625mm	D mm ²	V mm ²	Width 1195mm	D mm ²	V mm ²	Width 1195mm	D mm ²	V mm ²	Width 1765mm	D mm ²	V mm ²	Width 2334mm	D mm ²	V mm ²
745	SLEWH107CSDL	217074	312417	SLEWH207CSDL	519744	312417	SLEWH207CCSDL	450450	624834	SLEWH307CSDL	762867	624834	SLEWH407CMCSDL	996150	625443
895	SLEWH109CSDL	281424	389367	SLEWH209CSDL	661044	389367	SLEWH209CCSDL	562848	778734	SLEWH309CSDL	942468	778734	SLEWH409CMCSDL	1357884	778734
1045	SLEWH110CSDL	345774	466317	SLEWH210CSDL	802344	466317	SLEWH210CCSDL	691548	932634	SLEWH310CSDL	1148118	932634	SLEWH410CMCSDL	1604688	932634
1195	SLEWH112CSDL	410124	543267	SLEWH212CSDL	943644	543267	SLEWH212CCSDL	820248	1086534	SLEWH312CSDL	1353768	1086534	SLEWH412CMCSDL	1887288	1086534
1345	SLEWH113CSDL	474474	620217	SLEWH213CSDL	1084944	620217	SLEWH213CCSDL	948948	1240434	SLEWH313CSDL	1559418	1240434	SLEWH413CMCSDL	2169888	1240434

D = Daylight mm² V = Ventilation mm²

HORIZONTAL BAR – NARROW MODULE

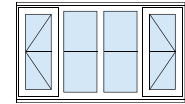
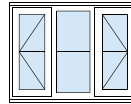
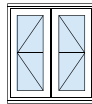
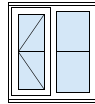
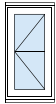

Height	Width 483mm	D mm ²	V mm ²	Width 910mm	D mm ²	V mm ²	Width 910mm	D mm ²	V mm ²	Width 1337mm	D mm ²	V mm ²	Width 1765mm	D mm ²	V mm ²
895	SLEWHN09CSDL	188272	285384	SLEWH2N09CSDL	466512	285384	SLEWH2N09CCSDL	376544	570768	SLEWH3N09CSDL	654784	570768	SLEWH4N09CMCSDL	1357884	778734
1045	SLEWHN10CSDL	231322	341784	SLEWH2N10CSDL	565962	341784	SLEWH2N10CCSDL	462644	683568	SLEWH3N10CSDL	797284	683568	SLEWH4N10CMCSDL	1131924	683568
1195	SLEWHN12CSDL	274372	398184	SLEWH2N12CSDL	665412	398184	SLEWH2N12CCSDL	548744	796368	SLEWH3N12CSDL	939784	796368	SLEWH4N12CMCSDL	1330824	796368
1345	SLEWHN13CSDL	317422	454584	SLEWH2N13CSDL	764862	454584	SLEWH2N13CCSDL	634844	909168	SLEWH3N13CSDL	1082284	909168	SLEWH4N13CMCSDL	1529724	909168

D = Daylight mm² V = Ventilation mm²

HORIZONTAL BAR – DIVIDED CASEMENT AND NARROW MODULE

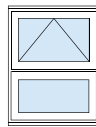
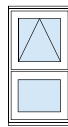
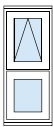

Height	Width 483mm	D mm ²	V mm ²	Width 625mm	D mm ²	V mm ²	Width 910mm	D mm ²	V mm ²
895	SLEWHN09D	153545	132164	SLEWH109D	229515	180319.5	SLEWH2N09D	381990	280497
1045	SLEWHN10D	196595	160364	SLEWH110D	293865	218794.5	SLEWH2N10D	489090	340347
1195	SLEWHN12D	239645	188564	SLEWH112D	358215	257269.5	SLEWH2N12D	596190	400197
1345	SLEWHN13D	282695	216764	SLEWH113D	422565	295744.5	SLEWH2N13D	703290	460047

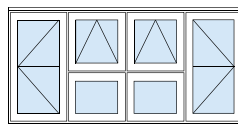
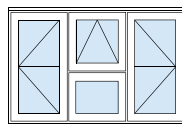
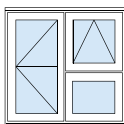

Height	Width 1195mm	D mm ²	V mm ²	Width 1765mm	D mm ²	V mm ²	Width 2334mm	D mm ²	V mm ²
895	SLEWFGH209CD	510939	569686.5	SLEWFGH309CDC	792363	959053.5	SLEWFGH409CDDC	1021878	1139373
1045	SLEWFGH210CD	639639	685111.5	SLEWFGH310CDC	985413	1151428.5	SLEWFGH410CDDC	1279278	1370223
1195	SLEWFGH212CD	768339	800536.5	SLEWFGH312CDC	1178463	1343803.5	SLEWFGH412CDDC	1536678	1601073
1345	SLEWFGH213CD	897039	915961.5	SLEWFGH313CDC	1371513	1536178.5	SLEWFGH413CDDC	1794078	1831923

D = Daylight mm² V = Ventilation mm²



All codes listed in this section refer to fully finished windows. For Stormsure Oak codes please refer to the JELD-WEN catalogue

ALL BAR

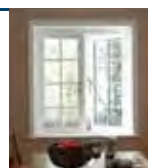
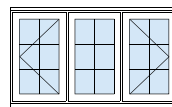
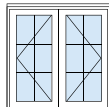
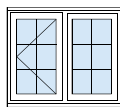
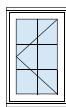

Height	Width 625mm	D mm ²	V mm ²	Width 1195mm	D mm ²	V mm ²	Width 1195mm	D mm ²	V mm ²	Width 1765mm	D mm ²	V mm ²
895	SLEWB109C	261170	389367	SLEWB209C	522340	389367	SLEWB209CC	579150	778734	SLEWB309CC	783510	778734
1045	SLEWB110C	322670	466317	SLEWB210C	645340	466317	SLEWB210CC	707850	932634	SLEWB310CC	968010	932634
1195	SLEWB112C	376380	543267	SLEWB212C	752760	543267	SLEWB212CC	836550	1086534	SLEWB312CC	1129140	1086534
1345	SLEWB113C	437880	620217	SLEWB213C	875760	620217	SLEWB213CC	965250	1240434	SLEWB313CC	1313640	1240434
1495	SLEWB115C	546975	697167	SLEWB215C	998760	647167	SLEWB215CC	731850	1008370	SLEWB315CC	1750575	1396146

D = Daylight mm² V = Ventilation mm²

ALL BAR – WITH CASEMENT VENTS

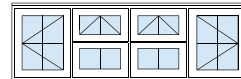
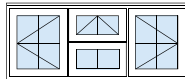
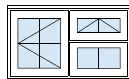

Height	Width 625mm	D mm ²	V mm ²	Width 1195mm	D mm ²	V mm ²	Width 1765mm	D mm ²	V mm ²	Width 2334mm	D mm ²	V mm ²
745	SLEWB107V	157850	125172	SLEWB207CV	365310	437589	SLEWB307CVC	599313	766678	SLEWB407CVVC	764478	908523
895	SLEWB109V	211560	125172	SLEWB209CV	472730	514539	SLEWB309CVC	733900	903906	SLEWB409CVVC	1021878	1139373
1045	SLEWB110V	273060	125172	SLEWB210CV	595730	591489	SLEWB310CVC	918400	1057806	SLEWB410CVVC	1191460	1182978
1195	SLEWB112V	326770	125172	SLEWB212CV	703150	668439	SLEWB312CVC	1079530	1211706	SLEWB412CVVC	1406300	1336878
1345	SLEWB113V	388270	125172	SLEWB213CV	826150	745389	SLEWB313CVC	1264030	1365606	SLEWB413CVVC	1652300	1490778

D = Daylight mm² V = Ventilation mm²

ALL BAR – TRANSOM

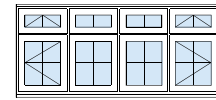
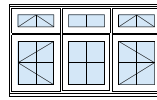
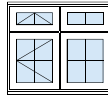

Height	Width 625mm	D mm ²	V mm ²	Width 1195mm	D mm ²	V mm ²	Width 1765mm	D mm ²	V mm ²	Width 2334mm	D mm ²	V mm ²
895	SLEWB109T	229515	360639	SLEWB209TX	590154	360639	SLEWB309TXT	783510	778734	SLEWB409TXXT	1510452	721278
1045	SLEWB110T	273060	437589	SLEWB210TX	731454	437589	SLEWB310TXT	776540	591489	SLEWB410TXXT	1784652	875178
1195	SLEWB112T	326770	514539	SLEWB212TX	872754	514539	SLEWB312TXT	1544139	1029078	SLEWB412TXXT	2058852	1029078
1345	SLEWB113T	388270	591489	SLEWB213TX	776540	591489	SLEWB313TXT	1164810	1182978	SLEWB413TXXT	2333052	11825978
1495	SLEWB115T	486915	668439	SLEWB215TX	883960	668439	SLEWB315TXT	1325940	1336878	SLEWB415TXXT	638780	1336878

D = Daylight mm² V = Ventilation mm²

ALL BAR – WITH CASEMENT VENTS AND NARROW MODULE

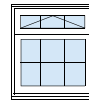
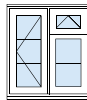
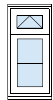

Height	Width 483mm	D mm ²	V mm ²	Width 910mm	D mm ²	V mm ²	Width 910mm	D mm ²	V mm ²
895	SLEWBN09V	148092	91744	SLEWB2N09CV	293314	377128	SLEWB2N09W	361660	114240
1045	SLEWBN10V	191142	91744	SLEWB2N10CV	373961	433528	SLEWB2N10W	450216	114240
1195	SLEWBN12V	228739	91744	SLEWB2N12CV	454608	489928	SLEWB2N12W	538772	114240

D = Daylight mm² V = Ventilation mm²

All codes listed in this section refer to fully finished windows.
For Stormsure Oak codes please refer to the JELD-WEN catalogue

ALL BAR – WITH CASEMENT AND NARROW MODULE

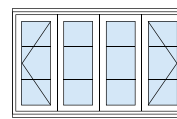
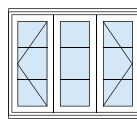
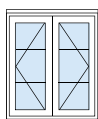
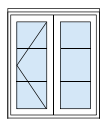
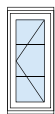

Height	Width 483mm	D mm ²	V mm ²	Width 910mm	D mm ²	V mm ²	Width 910mm	D mm ²	V mm ²	Width 1337mm	D mm ²	V mm ²	Width 1765mm	D mm ²	V mm ²
895	SLEWBN09C	182819	389367	SLEWB2N09C	479109	285384	SLEWB2N09CC	387450	570768	SLEWB3N09CC	672834	570768	SLEWB4N09CMC	958218	570768
1045	SLEWBN10C	225869	466317	SLEWB2N10C	578559	341784	SLEWB2N10CC	473550	683568	SLEWB3N10CC	815334	683568	SLEWB4N10CMC	1157118	683568
1195	SLEWBN12C	263466	543267	SLEWB2N12C	678009	398184	SLEWB2N12CC	559650	796368	SLEWB3N12CC	957834	796368	SLEWB4N12CMC	1356018	796368
1345	SLEWBN13C	301063	620217	SLEWB2N13C	777459	454584	SLEWB2N13CC	645750	909168	SLEWB3N13CC	1100334	909168	SLEWB4N13CMC	1554918	909168

REGENCY – NON BAR

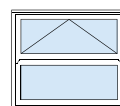
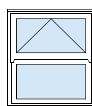
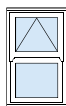
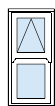

Height	Width 483mm	D mm ²	V mm ²	Width 625mm	D mm ²	V mm ²	Width 910mm	D mm ²	V mm ²	Width 1195mm	D mm ²	V mm ²
745	LEWSRN07	134603	103964	LEWSR107	201201	141844.5	LEWSR2N07	329612.5	220647	LEWSR207	468531	299450
895	LEWSRN09	177653	132164	LEWSR109	265551	180319.5	LEWSR2N09	435287.5	280497	LEWSR209	618381	380674.5
1045	LEWSRN10	220703	160364	LEWSR110	329901	218794.5	LEWSR2N10	540962.5	340347	LEWSR210	768231	461899.5
1195	LEWSRN12	263753	188564	LEWSR112	394251	252769.5	LEWSR2N12	646637.5	400197	LEWSR212	918081	543124.5
1345	LEWSRN13	306803	216764	LEWSR113	458601	295744.5	LEWSR2N13	752312.5	460047	LEWSR213	1067931	624349.5
1495	LEWSRN15	371378	244964	LEWSR115	555126	334219.5	LEWSR2N15	857987.5	519897	LEWSR215	1292706	705574.5
1645	LEWSRN16	435953	273164	LEWSR116	611668.5	372694.5	LEWSR2N16	963662.5	579747	LEWSR216	125773.5	786799.5

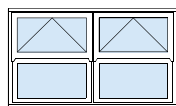
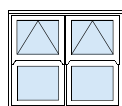

Height	Width 1195mm	D mm ²	V mm ²	Width 1765mm	D mm ²	V mm ²
745	LEWSR207D	402402	283689	LEWSR4N07	669732	441294
895	LEWSR209D	531102	360639	LEWSR4N09	883932	560994
1045	LEWSR210D	659802	437589	LEWSR4N10	1098132	680694
1195	LEWSR212D	788502	514539	LEWSR4N12	1312332	800394
1345	LEWSR213D	917202	745381	LEWSR4N13	1526532	920094
1495	LEWSR215D	1110252	668439	LEWSR4N15	1847832	1039794
1645	LEWSR216D	623337	668439	LEWSR4N16	2062032	1159494



D = Daylight mm² V = Ventilation mm²

REGENCY – VERTICAL BAR

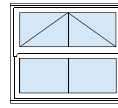
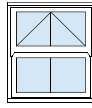
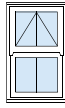
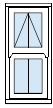

Height	Width 483mm	D mm ²	V mm ²	Width 625mm	D mm ²	V mm ²	Width 910mm	D mm ²	V mm ²	Width 1195mm	D mm ²	V mm ²
745	LEWSRN07	134603	103964	LEWSRV107	192290	141844.5	LEWSRV2N07	354434.5	220647	LEWSRV207	459620	299450
895	LEWSRN09	177653	132164	LEWSRV109	253790	180319.5	LEWSRV2N09	466409.5	280497	LEWSRV209	606620	380674.5
1045	LEWSRN10	220703	160364	LEWSRV110	315290	218794.5	LEWSRV2N10	578384.5	340347	LEWSRV210	753620	461899.5
1195	LEWSRN12	263753	188564	LEWSRV112	376790	257269.5	LEWSRV2N12	690359.5	400197	LEWSRV212	900620	543124.5
1345	LEWSRN13	306803	216764	LEWSRV113	438290	295744.5	LEWSRV2N13	802334.5	460047	LEWSRV213	1047620	624349.5
1495	LEWSRN15	371378	244964	LEWSRV115	499790	334219.5	LEWSRV2N15	914309.5	519897	LEWSRV215	1194620	705574.5
1645	LEWSRN16	435953	273164	LEWSRV116	561290	372694.5	LEWSRV2N16	1026284.5	579747	LEWSRV216	1341620	786799.5

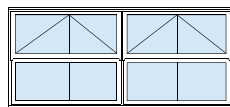
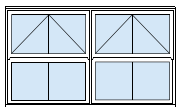

Height	Width 1765mm	D mm ²	V mm ²	Width 2334mm	D mm ²	V mm ²
745	LEWSRV4N07	651910	441294	LEWSRV407	919240	598899
895	LEWSRV4N09	860410	560994	LEWSRV409	1213240	761349
1045	LEWSRV4N10	1068910	680694	LEWSRV410	1507240	923799
1195	LEWSRV4N12	1277410	800394	LEWSRV412	1801240	1086249
1345	LEWSRV4N13	1485910	920094	LEWSRV413	2095240	1248699
1495	LEWSRV4N15	1694410	1039794	LEWSRV415	2389240	1411149
1645	LEWSRV4N16	1902910	1159494	LEWSRV416	2683240	1573599



D = Daylight mm² V = Ventilation mm²

REGENCY – ALL BAR

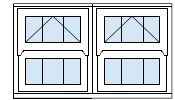
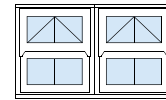
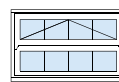

Height	Width 483mm	D mm ²	V mm ²	Width 625mm	D mm ²	V mm ²	Width 910mm	D mm ²	V mm ²	Width 1195mm	D mm ²	V mm ²	Width 1195mm	D mm ²	V mm ²	Width 1765mm	D mm ²	V mm ²
745	LEWSRBN07	134603	103964	LEWSRB107	192290	141844.5	LEWSRB2N07	317044	220647	LEWSRB207	441798	299449.5	LEWSRB207D	400160	283689	LEWSRB4N07	669732	441294
895	LEWSRBN09	172200	103964	LEWSRB109	246000	141844.5	LEWSRB2N09	405600	220647	LEWSRB209	565200	299449.5	LEWSRB209D	507580	360639	LEWSRB4N09	883932	560994
1045	LEWSRBN10	215250	103964	LEWSRB110	307500	141844.5	LEWSRB2N10	507000	220647	LEWSRB210	706500	299449.5	LEWSRB210D	829840	437589	LEWSRB4N10	1014000	441294
1195	LEWSRBN12	138477.5	188564	LEWSRB112	361210	257269.5	LEWSRB2N12	595556	326170	LEWSRB212	829902	543124.5	LEWSRB212D	937260	514539	LEWSRB4N12	1191112	652340
1345	LEWSRBN13	181527.5	188564	LEWSRB113	422710	257269.5	LEWSRB2N13	696956	326170	LEWSRB213	971202	543124.5	LEWSRB213D	1044680	745381	LEWSRB4N13	1393912	652340
1495	LEWSRBN15	219124.5	188564	LEWSRB115	476420	257269.5	LEWSRB2N15	785512	326170	LEWSRB215	1094604	543124.5	LEWSRB215D	1110252	668439	LEWSRB4N15	1571024	652340
1645	LEWSRBN16	435953	273164	LEWSRB116	537920	257269.5	LEWSRB2N16	886912	326170	LEWSRB216	1235904	543124.5	LEWSRB216D	623337	668439	LEWSRB4N16	1773824	652340

D = Daylight mm² V = Ventilation mm²

SLIDING SASH

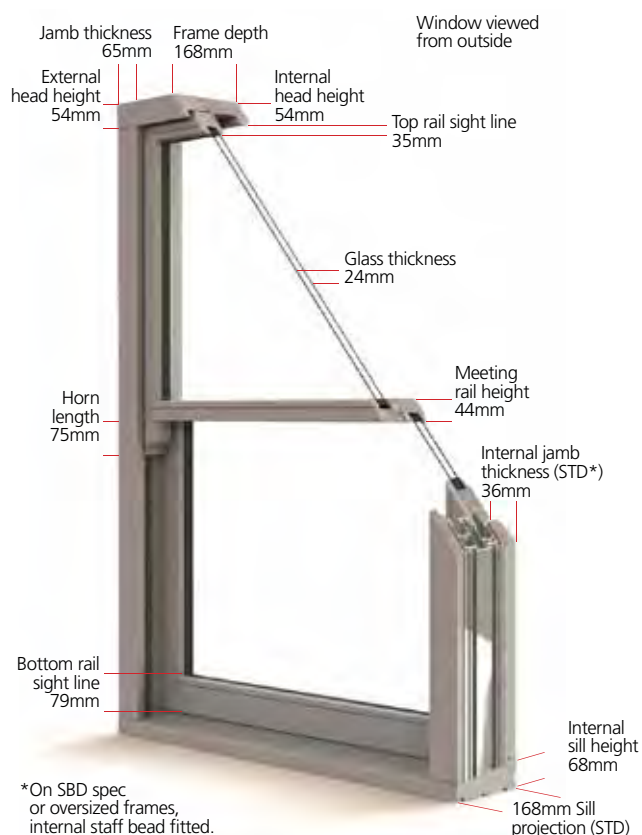

Our softwood timber Sliding Sash windows combine an authentic period feel with modern engineering to match local architectural style and planning requirements. This fully weather stripped range features stepped sashes for improved performance with horns to the top sash.

- U values available 1.4 W/m²K, BFR energy rated B
- Engineered softwood timber
- Double glazed with black warm edge spacer bar as standard, white and grey optional
- Polished chrome fit catch and lift as standard, other options available see page 156 for more hardware information
- Factory finished in Hi-Build white paint as standard, other RAL colour options available – see page 152 for finishing details
- Design options – Non Bar, Victorian Bar, All Bar, Marginal Bar, Vertical Bar and designer options available
- Standard and made to measure sizes available. CAD drawings are available on our website
- FSC certified, Chain of Custody on request
- Venetian style sliding sash windows that are 3 lites (1665mm and 1890mm wide) are supplied as standard with fixed outer sashes. Sliding sashes are available as special order
- Large windows may be supplied with loose sashes to reduce the risk of damage and to assist in manual handling and fixing
- Tilt facility for easy cleaning and maintenance as standard on most standard sizes. PAS 24, Secured by Design and oversized windows have staff beads fitted internally which disables this facility
- Factory glazed windows are CE Marked, see page 26 for glazing options
- RIBA timber window CPD seminar available, book online
- Spiral balance as standard, assisted lift spiral balance available as a special order
- PAS 24 specification options available to meet the requirements of Approved Document Q and Secured by Design. 405mm window widths will be supplied with fixed sashes. The minimum width for opening sash is 448mm
- For full specification details see page 24





Glazing

Using glazing rebates of 18mm x 42mm, our Sliding Sash windows will accept 24mm (4:16:4) insulating glass units as standard. The glazing system is fully drained and vented. A full 5mm clearance is provided between the insulating glass unit and rebate, in compliance with BS 6262.

Ventilation

Face fixed Titon Trimvent® select ventilators are fitted as standard to all Vertical Sliding windows to assist in compliance with Approved Document F of the Building Regulations. These provide an Equivalent Area of 5214mm² fitted on windows 860mm and wider and 2607mm² on windows below that size. Windows below 483mm wide are not fitted with ventilators. This product is also available with no trickle ventilation at time of order.

Sill Detail

A standard flush 168mm sill is available as well as extended sills to widths of 225mm. Care must be taken to ensure that the correct sill width is specified to suit the brickwork detail and Approved Document L.

PLAIN GLAZED AND BAR DESIGN OPTIONS

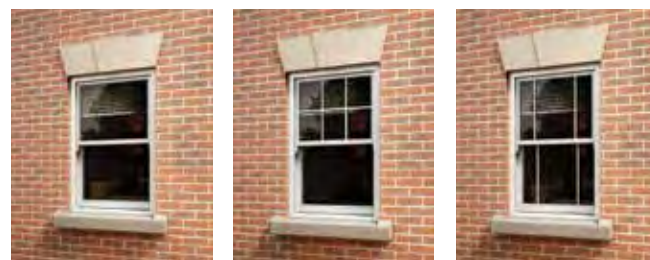

Plain

Victorian Bar

Marginal Bar



Vertical Bar

All Bar



dB reductions up to: 31dB



U-Value available down to: 1.5 W/m²K



Fire egress available to assist with compliance of Approved Document B



Background ventilation provided, to assist with compliance of Approved Document F



SECTION DETAILS

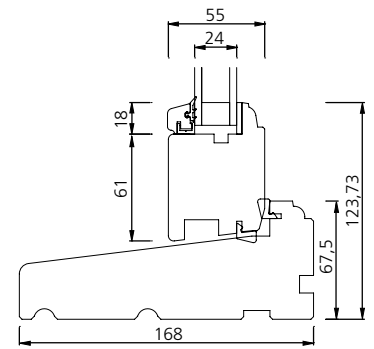
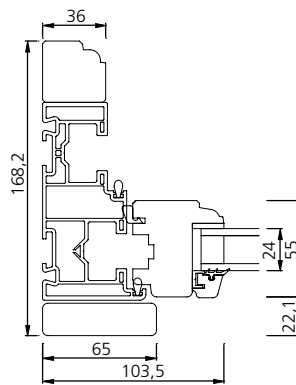
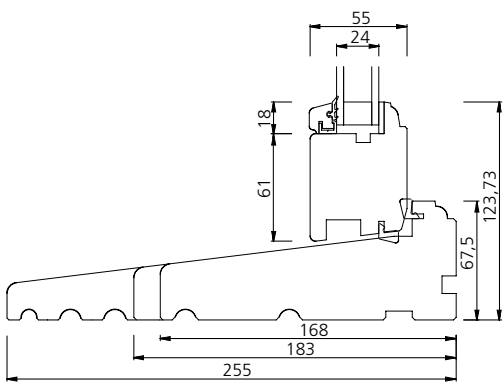
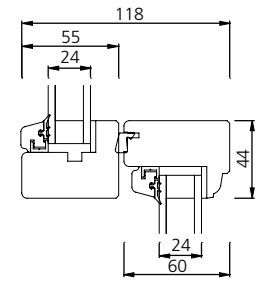
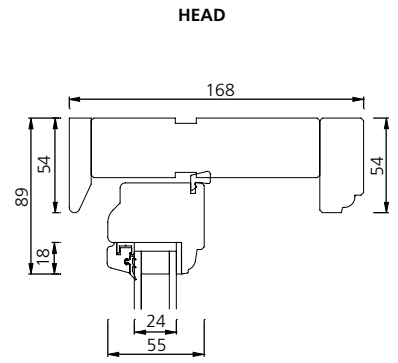
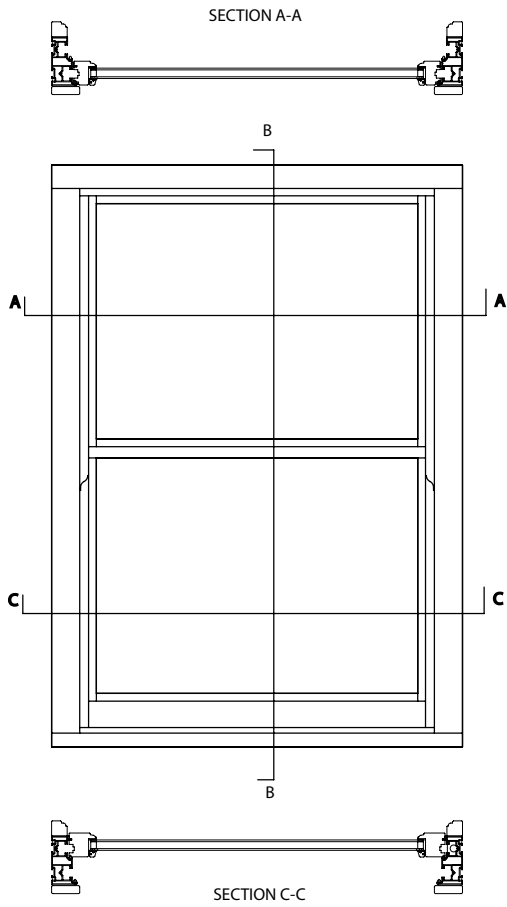

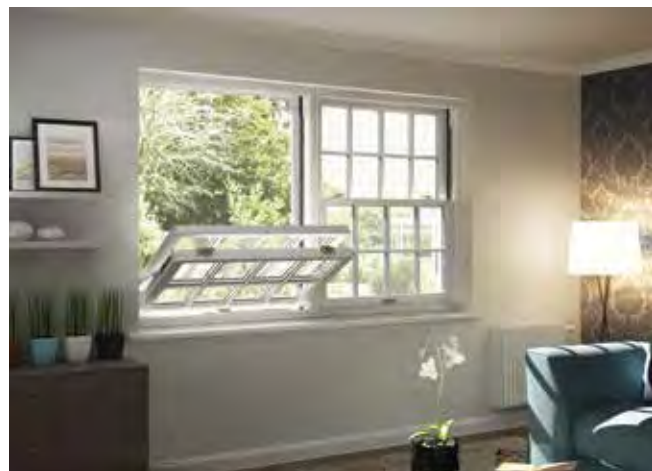
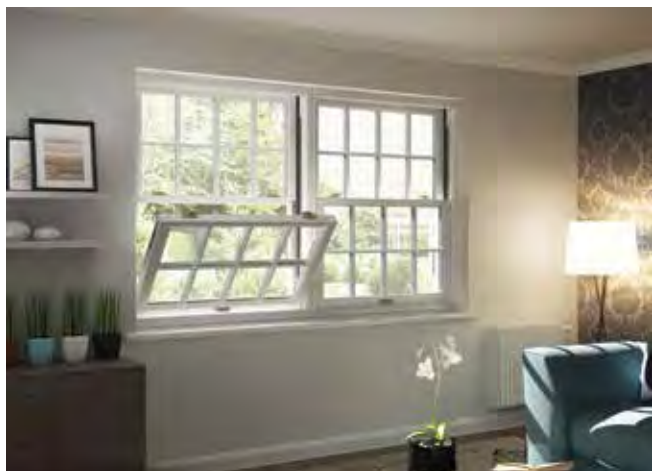

SIZE LIMITATIONS

Our Sliding Sash range is available as standard sizes or made to measure. When specifying made to measure products, the below limitations should be used as a guide to what can be manufactured.

	Min Frame Width (mm)	Min Frame Height (mm)	Max Frame Width (mm)	Max Frame Height (mm)
Frame and sash	385	745	1495*	2600*

All opening sash sizes are available as fixed sashes.

Please note, configuration limitations vary within the min/max dimensions due to weight and sash proportions.

For further detailed sizing please contact our estimating department on 0845 1222892.

* Internal staff beads fitted to windows exceeding 1200mm wide and/or 1650mm high. This prevents the tilt facility.

Secured by Design window below 450mm wide will have fixed sashes. 450mm and above will have opening sashes if required.

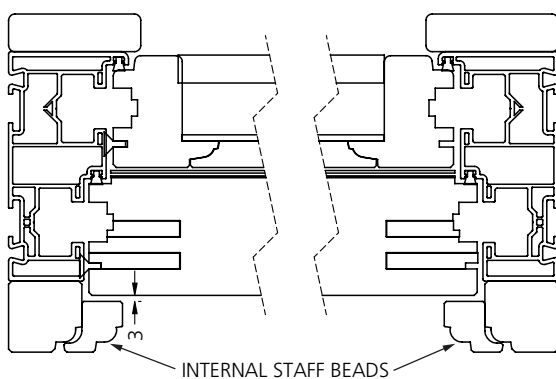

SECURED BY DESIGN JAMB

(Includes oversized frames)

ACOUSTIC PERFORMANCE

External noise reduction is required from various different sources. These can either be road traffic, air traffic, rail or pedestrians. Depending on the different sources, certain frequencies will be relatively higher which results in a significant reduction required for this specific band of frequency. These tables detail these bands, which will enable you to see the exact performance of the product.

Sliding Sash

2x Titon Select S 16 4000 trickle vents both closed

Freq F HZ	Sound Reduction Index, dB	
	1/3 Octave	1/1 Octave
100	20.7	18.3
125	16.9	
160	18.1	
200	18.0	20.4
250	21.9	
315	23.0	
400	21.8	18.3
500	20.0	
630	15.5	
800	16.5	18.6
1000	20.3	
1250	20.2	
1600	20.8	23.3
2000	24.4	
2500	27.3	
3150	27.9	28.8
4000	28.8	
5000	29.8	

Rating according to BS EN ISO 717-1:1997
Rw(C;Ctr) = 21 (0;-2) dB

Sliding Sash

2x Titon Select S 16 4000 trickle vents both open

Freq F HZ	Sound Reduction Index, dB	
	1/3 Octave	1/1 Octave
100	19.4	17.3
125	16.0	
160	17.2	
200	17.6	19.8
250	21.1	
315	22.4	
400	21.7	19.1
500	20.6	
630	16.7	
800	12.6	14.1
1000	13.6	
1250	17.3	
1600	16.4	18.7
2000	19.2	
2500	22.9	
3150	24.0	25.3
4000	26.6	
5000	25.9	

Rating according to BS EN ISO 717-1:1997
Rw(C;Ctr) = 18 (-1;-2) dB

Sliding Sash

4-16-4 glass vents removed and blocked off

Freq F HZ	Sound Reduction Index, dB	
	1/3 Octave	1/1 Octave
50+	15.7	18.4
63+	19.5	
80+	22.8	
100	15.8	17.4
125	20.8	
160	16.9	
200	14.2	18.1
250	21.4	
315	30.2	
400	26.4	28.2
500	29.2	
630	29.9	
800	30.3	30.9
1000	31.3	
1250	31.3	
1600	31.8	32.9
2000	33.4	
2500	33.9	
3150	33.3	34.7
4000	35.0	
5000	36.5	
6300+	39.8	41.4
8000+	41.4	
10000+	44.2	
Average 100-3150		26.9

Rating according to BS EN ISO 717-1:1997
Rw(C;Ctr) = 30 (-1; -4) dB

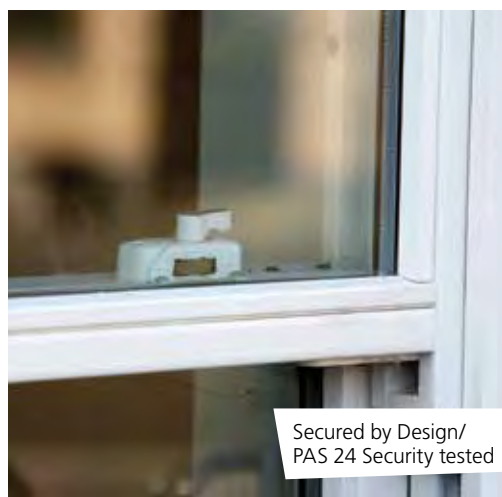

Secured by Design/
PAS 24 Security tested



All Bar

Sliding Sash

4-16-6.8PVB glass 2 x Titon R16-4000 vents - closed

Freq F HZ	Sound Reduction Index, dB	
	1/3 Octave	1/1 Octave
50+	16.2	18.6
63+	20.2	
80+	21.4	
100	17.0	17.9
125	20.4	
160	17.0	
200	18.7	21.7
250	23.4	
315	26.5	
400	24.7	21.2
500	23.0	
630	18.4	
800	14.4	17.2
1000	18.8	
1250	21.4	
1600	18.7	21.0
2000	21.3	
2500	25.1	
3150	24.9	25.0
4000	24.2	
5000	26.3	
6300+	30.9	34.1
8000+	35.5	
1000+	40.9	
Average 100-3150		20.9

Rating according to BS EN ISO 717-1:1997
Rw(C;Ctr) = 21 (-1; -2) dB

Sliding Sash

4-16-6.8PVB glass vents removed and blocked off

Freq F HZ	Sound Reduction Index, dB	
	1/3 Octave	1/1 Octave
50+	19.2	20.9
63+	21.1	
80+	23.3	
100	18.6	19.8
125	22.8	
160	19.0	
200	19.4	23.1
250	25.5	
315	32.6	
400	29.9	30.5
500	31.1	
630	30.4	
800	30.2	30.5
1000	30.6	
1250	30.9	
1600	31.8	32.6
2000	32.7	
2500	33.3	
3150	34.3	35.6
4000	36.4	
5000	36.3	
6300+	38.8	40.9
8000+	41.1	
1000+	44.6	
Average 100-3150		28.3

Rating according to BS EN ISO 717-1:1997
Rw(C;Ctr) = 31 (0; -3) dB

Sliding Sash

4-16-6.8PVB glass 2 X Titon R16-4000 vents - open

Freq F HZ	Sound Reduction Index, dB	
	1/3 Octave	1/1 Octave
50+	14.6	17.4
63+	19.6	
80+	20.5	
100	16.4	17.5
125	20.7	
160	16.5	
200	18.1	21.2
250	23.4	
315	25.4	
400	24.9	22.3
500	23.4	
630	20.0	
800	14.5	16.0
1000	15.2	
1250	20.0	
1600	17.8	19.7
2000	19.8	
2500	23.0	
3150	21.1	22.3
4000	21.8	
5000	23.3	
6300+	27.7	30.7
8000+	31.7	
1000+	37.2	
Average 100-3150		20.1

Rating according to BS EN ISO 717-1:1997
Rw(C;Ctr) = 19 (0; -1) dB

PURGE VENTILATION AND DAYLIGHT AREA FIGURES

Purge ventilation is manually controlled ventilation of rooms or spaces at a relatively high rate to rapidly dilute pollutants and/or water vapour. Purge ventilation may be provided by natural means, eg. by a window that opens, or by mechanical means eg. a fan. For a window that opens 30° or more or for vertical sliding sash windows, the height x width of the opening part should be at least 1/20th of the floor area of the room. The same rule applies to windows opening between 15° - 30°, however the width x height should be at least 1/10th of the floor area. If the window opens less than 15°, then the window is not suitable for purge ventilation and other arrangements should be made. All of our windows when specified as opening will open past 30° unless a restrictor is specified.

Below we provide purge ventilation and daylight figures for our standard sized products. If you require these figures for a made to measure product, then please follow the below calculation using the illustration provided.

Calculation for daylight figures

Width: Overall frame width (mm) minus A's
 Height: Overall frame height (mm) minus B's
 Width x height = mm² of daylight

Calculation for purge ventilation figures

Width: Overall frame width (mm) minus C's
 Height: Overall frame height (mm) minus D's
 Width x height = mm² of purge ventilation

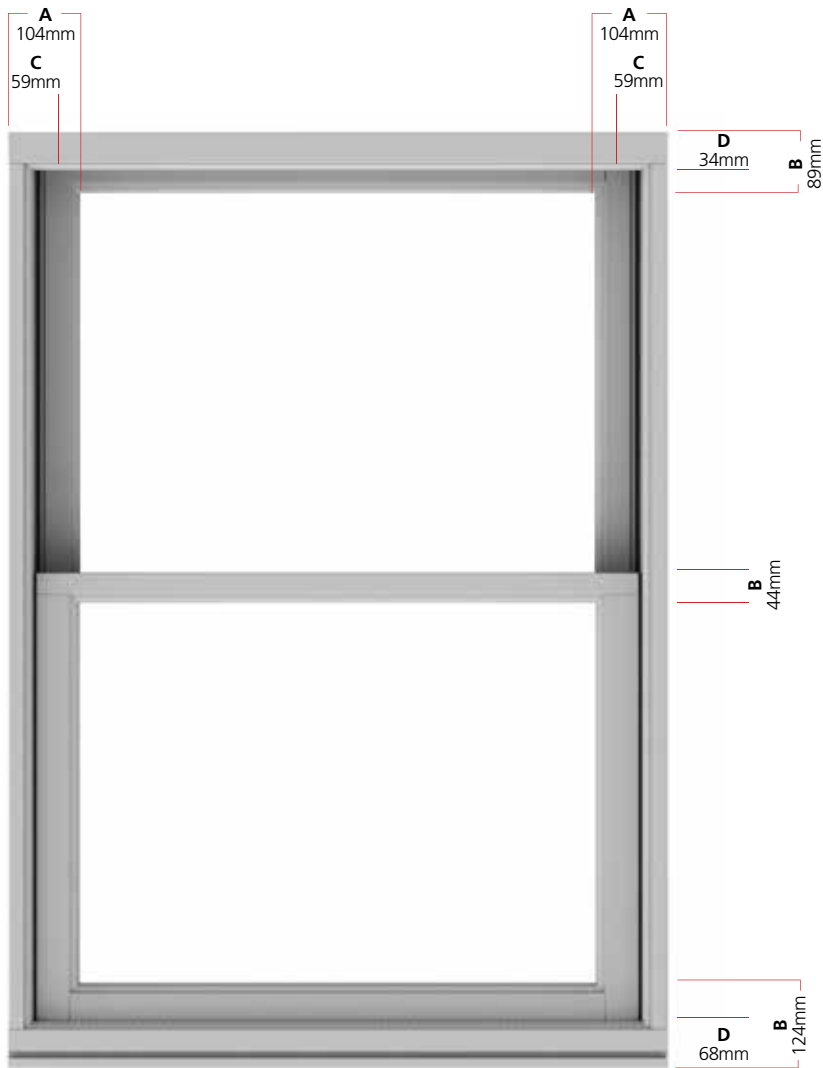

C referencing external jamb liner (not visible on drawing)

Internal view

SLIDING SASH



Height	Width 405mm	D mm ²	V mm ²	Width 630mm	D mm ²	V mm ²	Width 855mm	D mm ²	V mm ²	Width 1080mm	D mm ²	V mm ²
1045	SLETVS0410	156024	109450	SLETVS0610	333324	199000	SLETVS0810	510624	288550	SLETVS1010	687924	378100
1195	SLETVS0412	185724	130075	SLETVS0612	396774	236500	SLETVS0812	607824	342925	SLETVS1012	818874	449350
1345	SLETVS0413	215424	150700	SLETVS0613	460224	274000	SLETVS0813	705024	397300	SLETVS1013	949824	520600
1495	SLETVS0415	245124	171325	SLETVS0615	523674	311500	SLETVS0815	802224	451675	SLETVS1015	1080774	591850
1645	SLETVS0416	274824	191950	SLETVS0616	587124	349000	SLETVS0816	899424	506050	SLETVS1016	1211724	663100
1795	SLETVS0418	304524	212575	SLETVS0618	650574	386500	SLETVS0818	996624	560425	SLETVS1018	1342674	734350
2095	SLETVS0421	363924	233200	SLETVS0621	714024	424000	SLETVS0821	1093824	700450	SLETVS1021	1604574	876850

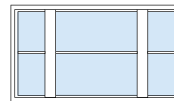
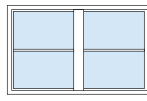
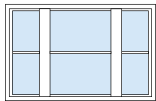

Height	Width 1665mm	D mm ²	V mm ² SL open	V mm ² SL fixed	Width 1710mm	D mm ²	V mm ²	Width 1890mm	D mm ²	V mm ² SL open	V mm ² SL fixed
1045	SLETVS1610	822672	507450	288550	SLETVS1710	1021248	577100	SLETVS1810	999972	597000	378100
1195	SLETVS1612	979272	603075	342925	SLETVS1712	1215648	685850	SLETVS1812	1190322	709500	449350
1345	SLETVS1613	1135872	698700	397300	SLETVS1713	1410048	794600	SLETVS1813	1380672	822000	520600
1495	SLETVS1615	1292472	794325	451675	SLETVS1715	1604448	903350	SLETVS1815	2570994	934500	591850
1645	SLETVS1616	1449072	889950	506050	SLETVS1716	1798848	1012100	SLETVS1816	1761372	1047000	663100
1795	SLETVS1618	1605672	985575	560425	SLETVS1718	1993248	1120850	SLETVS1818	3761316	1159500	734350
2095	SLETVS1621	1918872	1176825	669175	SLETVS1721	2382048	1338350	SLETVS1821	6141960	1384500	876850

D = Daylight mm² V = Ventilation mm²

SLIDING SASH – MARGINAL BAR (SIMULATED DIVIDED LITES)

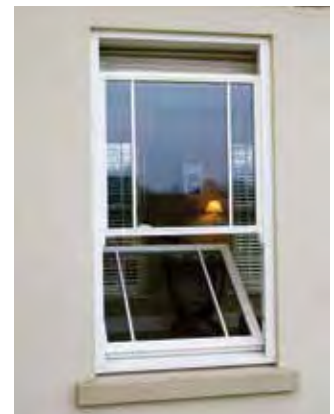
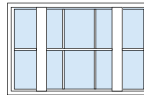
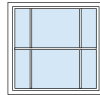

Height	Width 855mm	D mm ²	V mm ²	Width 1080mm	D mm ²	V mm ²	Width 1665mm	D mm ²	V mm ² SL open	V mm ² SL fixed
1045	SLESVS0810MB	480680	288550	SLESVS1010MB	657980	378100	SLESVS1610MB	792728	507450	288550
1195	SLESVS0812MB	572180	342925	SLESVS1012MB	783230	449350	SLESVS1612MB	943628	603075	342925
1345	SLESVS0813MB	663680	397300	SLESVS1013MB	908480	520600	SLESVS1613MB	1094528	698700	397300
1495	SLESVS0815MB	755180	451675	SLESVS1015MB	1033730	591850	SLESVS1615MB	1245428	794325	451675
1645	SLESVS0816MB	846680	506050	SLESVS1016MB	1158980	663100	SLESVS1616MB	1396328	889950	506050
1795	SLESVS0818MB	938180	560425	SLESVS1018MB	1284230	734350	SLESVS1618MB	1547228	985575	560050
2095	SLESVS0821MB	1121180	669175	SLESVS1021MB	1534730	876850	SLESVS1621MB	1849028	1176825	669175

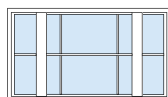
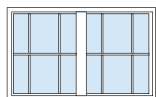

Height	Width 1710mm	D mm ²	V mm ²	Width 1890mm	D mm ²	V mm ² SL open	V mm ² SL fixed
1045	SLESVS1710MB	961360	577100	SLESVS1810MB	970028	597000	378100
1195	SLESVS1712MB	1144360	685850	SLESVS1812MB	1154678	709500	449350
1345	SLESVS1713MB	1327360	794600	SLESVS1813MB	1339328	822000	520600
1495	SLESVS1715MB	1510360	903350	SLESVS1815MB	1523978	934500	591850
1645	SLESVS1716MB	1693360	1012100	SLESVS1816MB	1708628	1047000	663100
1795	SLESVS1718MB	1876360	1120850	SLESVS1818MB	1893278	1159500	734350
2095	SLESVS1721MB	2242360	1338350	SLESVS1821MB	2262578	1384500	876850

SLIDING SASH – ALL BAR (SIMULATED DIVIDED LITES)



Height	Width 405mm	D mm ²	V mm ²	Width 630mm	D mm ²	V mm ²	Width 855mm	D mm ²	V mm ²	Width 1080mm	D mm ²	V mm ²
1045	SLESVS0410B	152262	68200	SLESVS0610B	310676	124000	SLESVS0810B	469090	179800	SLESVS1010B	627504	316200
1345	SLESVS0413B	207900	150700	SLESVS0613B	424200	274000	SLESVS0813B	640500	397300	SLESVS1013B	856800	520600
1645	SLESVS0416B	263538	150700	SLESVS0616B	537724	274000	SLESVS0816B	811910	397300	SLESVS1016B	1086096	520600

D = Daylight mm² V = Ventilation mm²

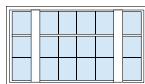
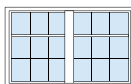

Height	Width 1665mm	D mm ²	V mm ² SL open	V mm ² SL fixed	Width 1710mm	D mm ²	V mm ²	Width 1890mm	D mm ²	V mm ² SL open	V mm ² SL fixed
1045	SLESVS1610B	773614	316200	179800	SLESVS1710B	938180	359600	SLESVS1810B	932028	372000	235600
1345	SLESVS1613B	848400	698700	397300	SLESVS1713B	1281000	794600	SLESVS1813B	1272600	822000	520600
1645	SLESVS1616B	1613172	698700	397300	SLESVS1716B	1623820	794600	SLESVS1816B	1613172	822000	520600

D = Daylight mm² V = Ventilation mm²



SLIDING SASH – SEMI-CIRCULAR

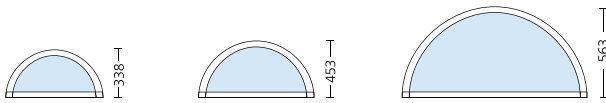

Width 630mm	D mm ²	Width 855mm	D mm ²	Width 1080mm	D mm ²
SLEVSSEM6	91751	SLEVSSEM8	199709	SLEVSSEM10	345710

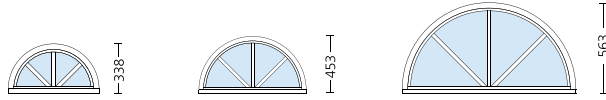

Width 630mm	D mm ²	Width 855mm	D mm ²	Width 1080mm	D mm ²
SLEVSSEM6SD	91751	SLEVSSEM8SD	199709	SLEVSSEM10SD	345710

SLIDING SASH – VERTICAL BAR (SIMULATED DIVIDED LITES)

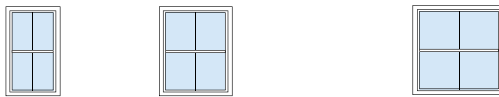

Height	Width 630mm	D mm ²	V mm ²	Width 855mm	D mm ²	V mm ²	Width 1080mm	D mm ²	V mm ²
1045	SLEVS0610VB	318352	199000	SLEVS0810VB	495652	288550	SLEVS1010VB	672952	378100
1195	SLEVS0612VB	378952	236500	SLEVS0812VB	590002	342925	SLEVS1012VB	801052	449350
1345	SLEVS0613VB	439552	274000	SLEVS0813VB	684352	397300	SLEVS1013VB	929152	520600
1495	SLEVS0615VB	500152	311500	SLEVS0815VB	778702	451675	SLEVS1015VB	1057252	591850
1645	SLEVS0616VB	560752	349000	SLEVS0816VB	873052	506050	SLEVS1016VB	1185352	663100
1795	SLEVS0618VB	621352	386500	SLEVS0818VB	967402	560425	SLEVS1018VB	1313452	734350
2095	SLEVS0621VB	742552	461500	SLEVS0821VB	1156102	669175	SLEVS1021VB	1569652	876850

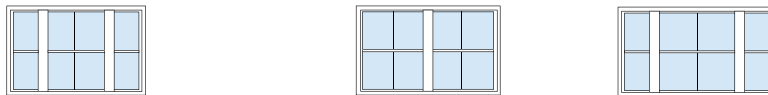

Height	Width 1665mm	D mm ²	V mm ² SL open	V mm ² SL fixed	Width 1710mm	D mm ²	V mm ²	Width 1890mm	D mm ²	V mm ² SL open	V mm ² SL fixed
1045	SLEVS1610VB	807700	507450	288550	SLEVS1710VB	495652	577100	SLEVS1810VB	985000	597000	378100
1195	SLEVS1612VB	961450	603075	342925	SLEVS1712VB	590002	685850	SLEVS1812VB	1172500	709500	449350
1345	SLEVS1613VB	1115200	698700	397300	SLEVS1713VB	684352	794600	SLEVS1813VB	1360000	822000	520600
1495	SLEVS1615VB	1268950	794325	451675	SLEVS1715VB	778702	903350	SLEVS1815VB	1547500	934500	591850
1645	SLEVS1616VB	1422700	889950	506050	SLEVS1716VB	873052	1012100	SLEVS1816VB	1735000	1047000	663100
1795	SLEVS1618VB	1576450	985575	560425	SLEVS1718VB	967402	1120850	SLEVS1818VB	1922500	1159500	734350
2095	SLEVS1621VB	1883950	1176825	669175	SLEVS1721VB	1156102	1338350	SLEVS1821VB	2297500	1384500	876850

D = Daylight mm² V = Ventilation mm²





BAY WINDOWS

We offer bay window solutions in almost every window design in our range, so you can achieve a continuous look throughout the whole property. Choose from square, splay or oriel bay window options from some of our most popular window designs.

For the commonly selected casement and Sliding Sash ranges we have provided information to guide you through the measuring process but there are other methods you can apply. Whatever method you decide, the junction between the window and the structure must comply with the relevant Building Regulations.

To help you further you can download the bay measuring forms at www.jeld-wen.co.uk

- Available in Elegance, Stormsure Casement, Regency and Sliding Sash windows
- A standard 45° splay bay (SP) and 90° square bay (SQ) will have 2 return ends of equal size. If you require a single return end (SQR or SPR) please specify when ordering
- Engineered softwood timber
- For primed and Hi-Build paint or stain factory finishing options see page 152. Basecoat stained windows are suitable for site Hi-Build painting or staining
- Trickle ventilators will generally be positioned centrally on the front module as standard with each bay
- Where the component window size allows ventilators can also be added to the returns
- We also supply 30°, 60° and Oriel bays which are available on special order
- Factory glazed windows are CE Marked, see page 26 for glazing options
- FSC certified, Chain of Custody on request
- NOTE: Bay windows are not designed to be load bearing, if in doubt contact your architect or our sales team on 0845 122 2892.



Installation and Building Regulations

Bay windows need careful consideration when planning building detail and installation. The Building Regulations Approved Document L requires the thermal performance around openings to achieve levels that some traditional methods of bay window installation cannot meet. Traditionally the various types of bays were set against plain brickwork with the joints made by butting the jambs or corner posts up to the brickwork. Most of these details create a cold bridge at this joint which is unacceptable under current regulations.

Scottish Building Regulations may vary so please check for information.

Square Bays – returned cavities

We recommend that brickwork is brought up to the edge of the window using angled or cut brick to replicate the joint between a flat window and the wall. This provides good thermal detail and an attractive finish.

The insulation of the horizontal roof and underside details of bay windows also require careful attention to ensure compliance, particularly where the bay projects beyond the structure. You will need to discuss this with your architect or building control officer.

How to order

To order your bay windows:

- 1 Complete the bay measuring form to provide brickwork dimensions – available to download from the website or by calling our sales team
- 2 For replacement windows also supply the existing window dimensions
- 3 Supply installation details (ie Approved Document L 2002 robust detail)
- 4 Provide a copy of the architects drawings if available – email to windowsuk@jeldwen.com or fax to 01664 503 403

If you do have any questions give us a call to discuss your requirements.

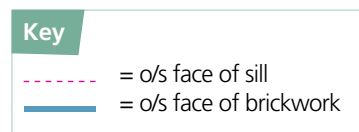

SQUARE BAY

STORMSURE CASEMENT - 90°

To meet the requirements of the published ‘robust detail’ and to achieve a 30mm overhang of the window frame over the cavity, a 158mm is needed when using plain brickwork. If a cant brick or similar detail is used the sill width will be different.

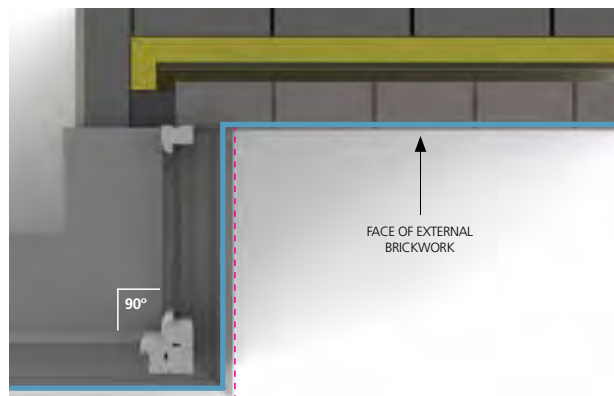

Examples of standard module

	Front module window frame width (exc. posts)	DIM A Brickwork	DIM B Brickwork
2 Lights on front elevation	1195mm	1439mm	752mm*
3 Lights on front elevation	1765mm	2008mm	752mm*
4 Lights on front elevation	2334mm	2578mm	752mm*

All standard module returns are 625mm excluding posts*

Examples of narrow module

	Front module window frame width (exc. posts)	DIM A Brickwork	DIM D Brickwork
2 Lights on front elevation	910mm	1154mm	609mm*
3 Lights on front elevation	1337mm	1581mm	609mm*
4 Lights on front elevation	1765mm	2009mm	609mm*

All standard module returns are 483mm excluding posts*



SLIDING SASH - 90°

Generally Sliding Sash bay windows are installed on stone sills or a similar detail, and can be installed using the 168mm standard flush sill. Other sill sizes are available upon request.

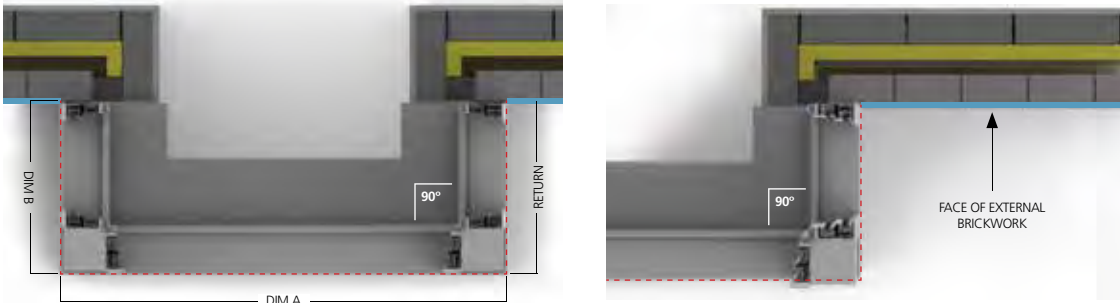

Examples of standard module

Bay front window frame size (exc. posts)	Bay return window frame size	DIM A Actual window size (inc. post)	DIM B Actual window size (inc. post)
1665mm	630mm	1979mm	787mm
1665mm	855mm	1979mm	1012mm
1710mm	630mm	2024mm	787mm
1710mm	855mm	2024mm	1012mm
1890mm	630mm	2204mm	787mm
1890mm	855mm	2204mm	1012mm

Inner block work and cavity details for illustration purposes only, design of wall construction may vary. Please consult your building designer for correct application.

SPLAY BAY

STORMSURE CASEMENT - 45°

To meet the requirements of the published 'robust detail' and to achieve a 30mm overhang of the window frame over the cavity a 158mm is needed when using plain brickwork. If a cant brick or similar detail is used the sill width will be different.

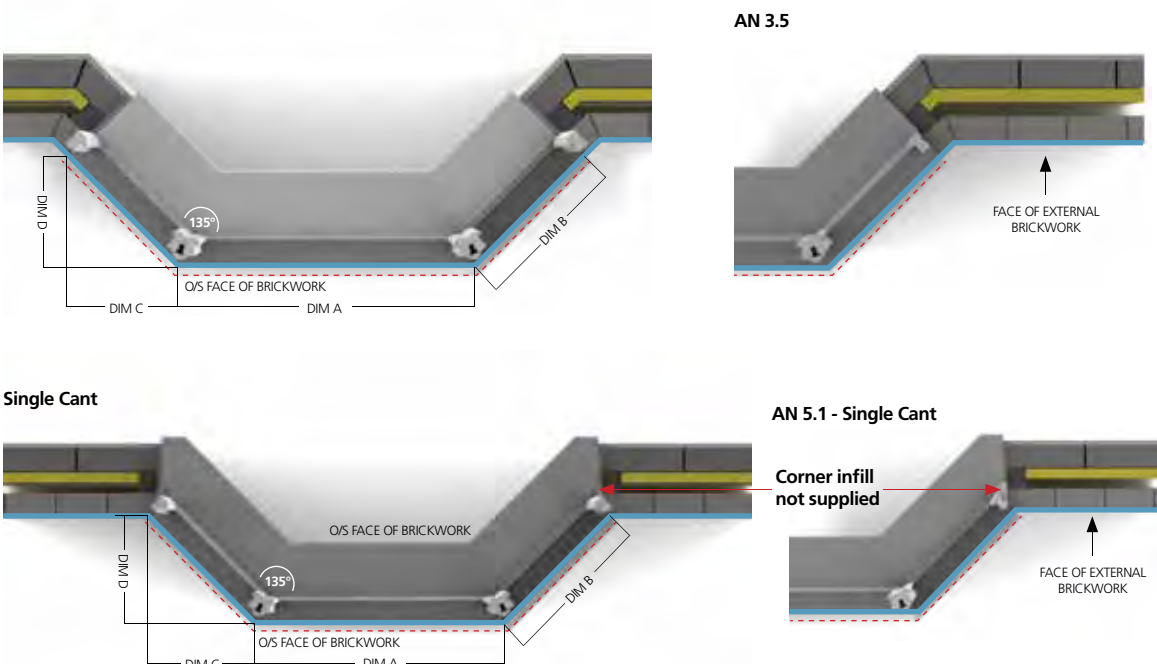

Example of 45° Splay Bay

45° Splay Bay Standard Module		All standard module returns are 625mm*			
	Front module window frame width*	DIM A Brickwork	DIM B Brickwork	DIM C Brickwork	DIM D Brickwork
2 Lights on front elevation	1195mm	1288mm	677mm	478mm	478mm
3 Lights on front elevation	1765mm	1858mm	677mm	478mm	478mm
4 Lights on front elevation	2334mm	2427mm	677mm	478mm	478mm

45° Splay Bay Narrow Module		All standard module returns are 483mm			
	Front module window frame width*	DIM A Brickwork	DIM B Brickwork	DIM C Brickwork	DIM D Brickwork
2 Lights on front elevation	910mm	1003mm	535mm	378mm	378mm
3 Lights on front elevation	1337mm	1430mm	535mm	378mm	378mm
4 Lights on front elevation	1765mm	1858mm	535mm	378mm	378mm

*Size excludes posts

SLIDING SASH - 45°

Generally sliding sash bay windows are installed on stone sills or a similar detail and can be installed using the 168mm standard flush sill. Other sill sizes are available upon request. **All dimensions on this section are actual frame size.**

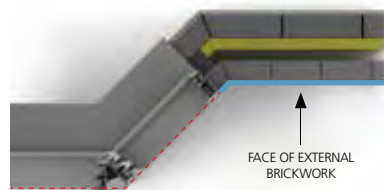
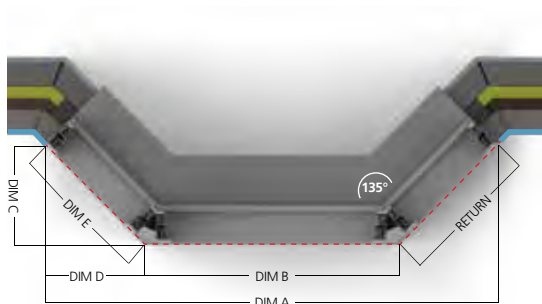

Sliding Sash, Splay Bay, All Bar

Examples of standard module

Bay front window frame size	Bay return window frame size (exc. posts)	DIM A Overall window width	DIM B Front elevation Actual window size inc. post (angle fillet)	DIM C Forward projection	DIM D Width projection	DIM E Actual window size inc. post (angle fillet)
1080mm	630mm	2163mm	1193mm	485mm	485mm	686mm
1080mm	855mm	2481mm	1193mm	644mm	644mm	911mm
1665mm	630mm	2746mm	1776mm	485mm	485mm	686mm
1665mm	855mm	3064mm	1776mm	644mm	644mm	911mm
1710mm	630mm	2791mm	1821mm	485mm	485mm	686mm
1710mm	855mm	3109mm	1821mm	644mm	644mm	911mm
1890mm	630mm	2971mm	2001mm	485mm	485mm	686mm
1890mm	855mm	3289mm	2001mm	644mm	644mm	911mm

EXTERIOR DOORSET SPECIFICATION COMPARISON GUIDE

This information provides you with a comparison of the specification across our exterior doorset range.

	INSULUX Timber Composite NEW	Castle Composite NEW DESIGNS
Operational detail	Open in/out left hand or right hand hung	Open in/out left hand or right hand hung
Door thickness	55mm	44mm
Door construction	AluClassic - insulating foam core, laminated veneer lumber stiles and rails. Routed Alutherm facings	Timber stiles and rails, insulating foam core, moulded thermoset GRP skins
Frame section size	50x91mm at head	56x66mm at head
Frame material	Engineered hardwood	Engineered softwood, oak or hardwood
Sill material	Hardwood standard. Aluminium option	Hardwood standard. Aluminium option
Sill sizes	Timber 170mm standard, 140mm option. 25mm low level aluminium threshold	Timber 170mm standard, 140mm option. Low level aluminium threshold
Beading	External timber composite pinless beading for painted finishes. Pinned hardwood for stain	Glazing cassette
Made to measure options	Yes	Yes
Standard doorset widths	854mm/943mm/1006mm	854mm/943mm/1006mm
Standard doorset heights	2086mm	2086mm
Finish	Factory paint & stain finish to frame and door including dual finish paint options	Fully finished slab choice of 7 external face colours. White internal finish. Factory finish options to frame
Locking detail	Multi-point espagnolette locking. Thumb-turn handle (chrome standard, gold option) with split spindle standard to front doors. Key/Key Vectis lock standard to rear doors	Multi-point espagnolette locking. Key/Key Vectis lock standard. Thumb-turn with split spindle option
Handles	Inline locking polished chrome standard or white, black, brushed chrome, bronze and gold options	Inline locking polished chrome standard or white, black, antique black, brushed chrome, bronze and gold options
Hardware accessories	Front doors: Chrome security chain, viewer, threshold & rain deflector. Gold option. Polished chrome letter plate to front doors as standard. Colour options see handles. White internal letter plate cowl supplied loose. Rear doors chain viewer and letter plate optional	Front doors: Chrome security chain, viewer, threshold & rain deflector. Gold option. Polished chrome letter plate to front doors as standard. Colour options see handles. White internal letter plate cowl supplied loose. Rear doors chain viewer and letter plate optional
Glazing	Double - 28mm Low-E insulating. Obscure Cotswold™ as standard. 6.8mm laminated/toughened. Other options available	Double - 24mm Low-E insulating. Obscure Cotswold™ as standard. Other options available
Bar designs	Not available	Not available
Side lights/top lights	Yes optional	Yes optional
U Values doorsets (factory glazed and panel)	1.2-1.6 W/m²K	1.0-1.2 W/m²K
Spacer bars	Black standard, white & grey optional	Black standard, white & grey optional
Ventilation detail	Not available	Not available
Brickwork tolerance guidance	12mm overall	12mm overall
Secured by Design	Yes standard	Yes optional
Approved Document Q	Yes standard	Yes optional
Approved Document M - M1	Yes 943mm and above	Yes 943mm and above
Exposure rating	800X	800X
Air permeability	Class 4	Class 2
Wind loading	Class C4	Class C2/C3
Performance testing	BS6375: Part 1:2009	BS6375: Part 1:2009
Strength/operation testing	BS6375: Part 2&3:2009	BS6375: Part 2&3:2009
Acoustic performance	No performance declared	No performance declared
Responsibility	FSC	FSC

FD30 Fire Castle Composite	NEW DESIGNS DreamVu™ Softwood	Farndale Softwood
Open in/out left hand or right hand hung	Open in or open out	Open in or open out
44mm	64mm	54mm
Hardwood stiles and rails, Fire resistant insulating foam core, moulded thermoset GRP skins	Engineered softwood	Engineered softwood
56x66mm at head	92mm front to back	91mm front to back
Engineered softwood	Engineered softwood	Engineered softwood
Hardwood standard. Aluminium option	Low level aluminium	Aluminium and timber
Timber 170mm standard, 140mm option. 25mm low level aluminium threshold	117mm open in 120mm open out	170mm
Glazing cassette	Timber-composite pinless beading on factory paint finished and glazed doorsets	Timber-composite pinless beading on factory paint finished and glazed doorsets
Yes	Yes	Yes
854mm/930/1006mm	844/920mm	844/930mm
2086mm	2088mm	2088mm
Fully finished slab choice of external face colours. White internal finish. Factory finish options to frame	Factory paint & stain finish to frame and door including dual finish paint options	Factory paint & stain finish to frame and door including dual finish paint options
Multi-point espagnolette locking. Thumb-turn (chrome standard, gold option) with split spindle standard. Key/Key operation option	PAS 3621/8621: 2011 Multi-point espagnolette locking,Key/Key Vectis lock	Multi-point espagnolette locking,Key/Key Vectis lock
Inline locking polished chrome standard or white, black, antique black, brushed chrome, bronze and gold options	Inline locking polished chrome standard or white, black, antique black, brushed chrome, bronze and gold options	Inline locking polished chrome standard or white, black, antique black, brushed chrome, bronze and gold options
Chrome or gold security chain, viewer, threshold & rain deflector. Letter plate for colour options see handles. White internal letter plate cowl supplied loose for PAS 24 option	Chrome threshold & rain deflector as standard, gold option	Chrome threshold & rain deflector as standard, gold option
Double - 24mm insulating. Obscure Cotswold™ as standard. Low-E & other options available	28mm toughened/laminated double glazing with triple optional. Clear as standard, other options available including simulated divided lite designs	28mm toughened double or triple glazing. Clear as standard, other options available including simulated divided lite options
Not available	Yes optional	Yes optional
Not available	Yes optional	Yes optional
1.5-2.0 W/m²k	1.1-1.5 W/m²K	1.1-1.6 W/m²K
Black standard, white & grey optional	Black standard, white & grey optional	Black standard, white & grey optional
Not available	None as standard	White as standard, brown, grey, green optional
12mm overall	12mm overall	12mm overall
Yes optional	Yes standard	Yes optional
Yes optional	Yes standard	Yes optional
930mm and above	961mm and above	952mm and above
No performance declared	800X	800X
Class 2	Class 3	Class 3
Class C2	Class C3	Class C3
BS6375: Part 1:2009	BS6375: Part 1:2009	BS6375: Part 1:2009
BS6375: Part 2&3:2009	BS6375: Part 2&3:2009	BS6375: Part 2&3:2009
No performance declared	Up to 34dB	Up to 31dB
FSC	FSC	FSC

CHOOSING THE RIGHT EXTERIOR DOORSETS

Exterior doorsets not only create a stylish entrance, but can also improve the security and thermal performance of a property.

Specifying exterior doorsets means balancing the desired look with budget and performance requirements. We have a range of standard and made to measure exterior doorsets to suit your exact project needs.

Our products are split broadly into engineered timber and GRP composite. Our new timber composite INSULUX range is manufactured with a combination of aluminium internal layers for added stability and security, with a foam core to give excellent thermal results.

Our Castle composites are manufactured from Glass Reinforced Plastic (GRP) to provide a stable construction for long lasting performance.

The DreamVu™ and Farndale single doorsets are manufactured from engineered softwood, which means that separate pieces of wood are permanently bonded together, providing a stronger dimensional stability.

Specifying exterior doorsets

There are a number of things to consider when specifying exterior doorsets:

- **Design** – The style and finish of the products need to reflect the building design, any planning guidance and the aspirations of the client.
- **Material** – the style and finish of the product needs to reflect the building design, any planning guidance and the aspirations of the client.
- **Building Regulations** – The Building Regulations for the replacement of windows and doors vary to new build, and there may be differences between England, Scotland and Wales who each have their own standards. See the Building Regulations section on page 8 for further information.
- **Security** – Clearly good locks are essential on any exterior door, which is why we fit the very best ERA multi-point systems as standard on our complete doorsets. For added safety, you can upgrade any of our doorsets to meet the requirements of the police approved Secured by Design scheme and Approved Document Q of the Building Regulations. Our new INSULUX range, comes with Secured by Design hardware as standard, along with the ERA Vectis multi-point locking system with thumb-turn operation.
- **Maintenance & Finishing** – We recommend choosing a fully finished doorset to minimise work post-delivery and ensure a high quality finish that is guaranteed for up to ten years. Our softwood and new INSULUX ranges can be painted in any RAL shade and dual colour finishes are available for a bespoke look inside and out. Composite doors have white interiors and a choice of seven exterior colour finishes.
- **Budget** – Consider whole life cycle costing depending on client requirements as timber is expected to last almost twice as long as PVC-U.
- **Responsibility** – Timber is the only truly sustainable building material and is carbon neutral, fully recyclable and biodegradable. All our exterior doorsets are FSC certified which means we have sourced wood from Chain of Custody forests that have been independently verified against worldwide standards.



INSULUX
Longleat,
Reed Green

THERMAL TRANSMITTANCE

The thermal performance of external joinery is an important consideration when specifying products to ensure their performance meets the required standards.

Thermal transmittance, also known as *U* values is the rate of transfer of heat (in watts) through one square metre of a structure divided by the difference in temperature across the structure. It is expressed in watts per metres squared kelvin, or W/m^2K . Well-insulated parts of a building have a low thermal transmittance whereas poorly insulated parts of a building have a high thermal transmittance.

U values in exterior doorsets are calculated in accordance with ISO-10077-2. Thermal performance of windows and doorsets is affected by various elements of the design including timber section size, glass specification and weather seals. JELD-WEN aims to offer a range of different products covering different *U* values to suit your requirements. Below are a number of graphs which illustrate how our ranges compare to provide guidance on range selection.

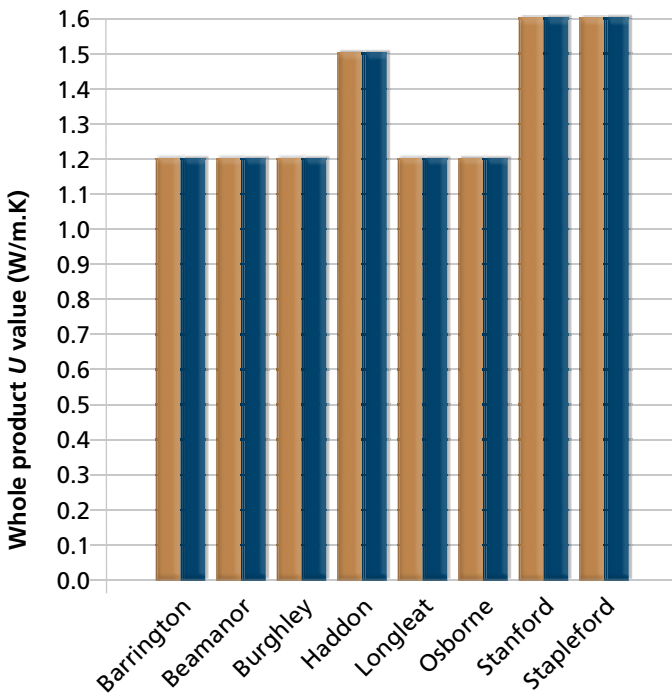

INSULUX Timber Composite Doorsets

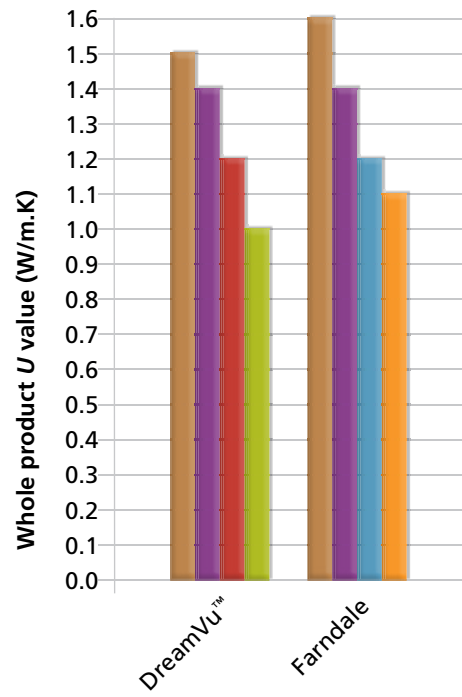

Softwood Single Doorsets

Key to Glazing Specification (mm)

- 4-20-4 Standard Low-E
- 4-20-4 Super Low-E
- 4-18-6.8 Super Low-E
- 4-8-4-8-4 Standard Low-E
- 4-8-4-8-4 Super Low-E
- 4-12-4-12-4 Standard Low-E
- 4-12-4-12-4 Super Low-E

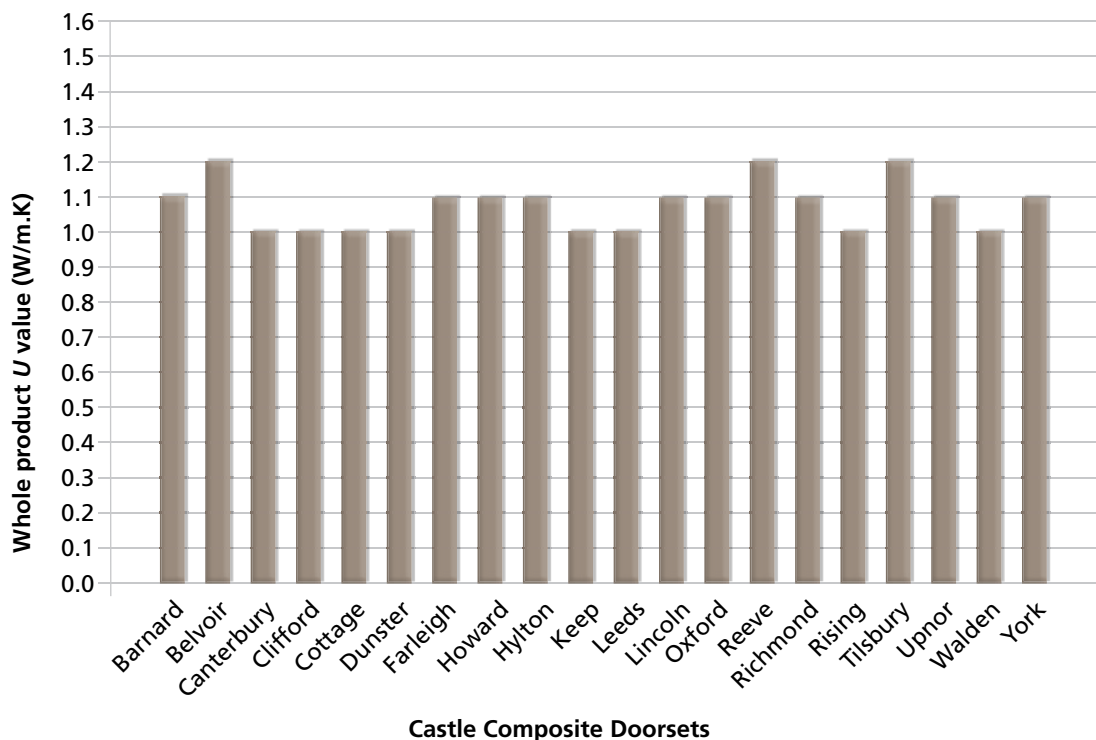

Key to Glazing Specification (mm)

- 4-14-6.8 No Low-E
- 4-14-6.8 Standard Low-E

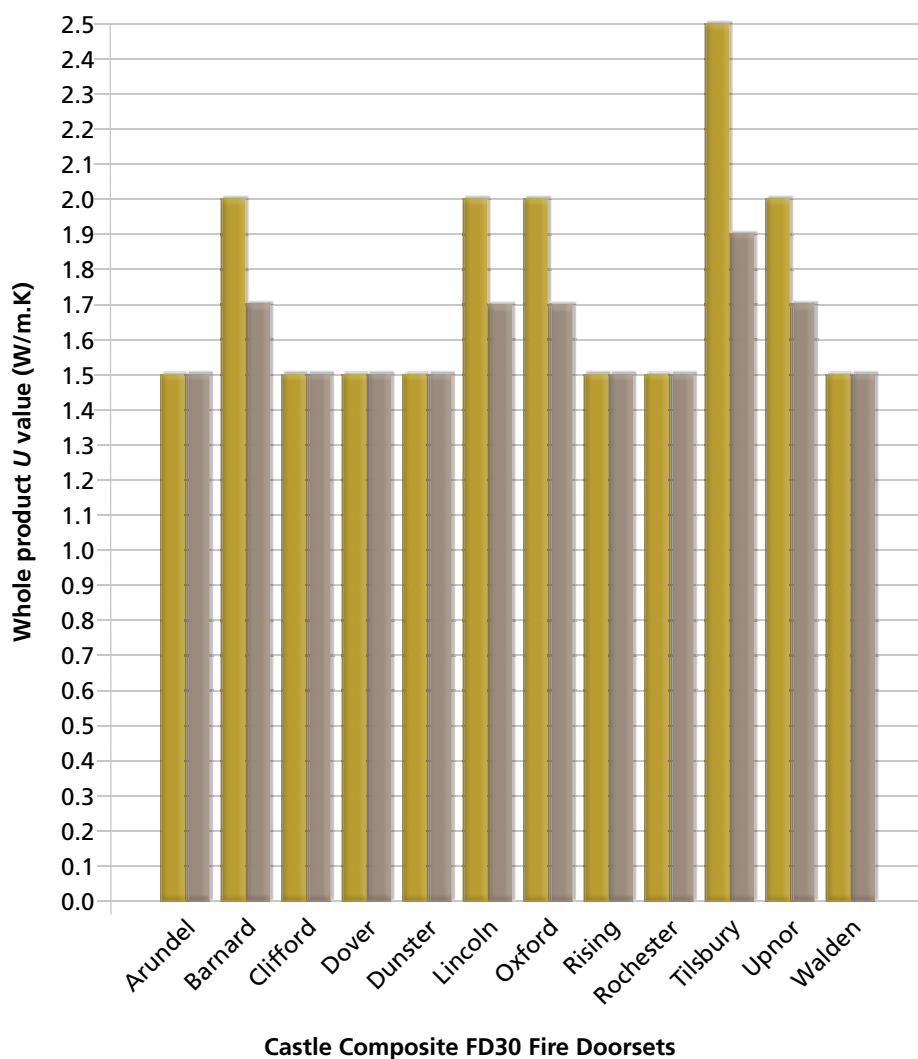

INSULUX

TIMBER COMPOSITE DOORSETS



Our new range of timber composite doorsets offer an advanced solution for added security and warmth. These solid timber composite doors have an AluClassic® construction which includes aluminium sheets giving added stability and security, and a foam core that delivers great U values down to $1.2 \text{ W/m}^2\text{K}$ for the whole doorset. The timber exteriors are routed to create beautiful, traditional designs to suit front and back doors giving a high quality look to a home.

- Left or right hand hung, open in or out options
- High thermal performance with U values down to $1.2 \text{ W/m}^2\text{K}$ for the doorset which exceeds Building Regulation requirements
- 55mm thick, high quality, pre-hung timber door in a hardwood frame with side lights and top lights. 170mm hardwood sill
- AluClassic® construction which includes routed timber faces, aluminium sheets and a foam core
- Made to measure and standard sizes available
- Top lights are direct glazed. Side lights are not direct glazed giving cleaner sight lines around the overall doorset
- PAS 24 specification as standard, meeting the requirements of Approved Document Q and Secured by Design
- ERA Vectis multi-point locking system with thumb-turn operation to meet Secured by Design standards. Key/key lock available
- 943mm doorset width and above comply with Approved Document M
- Painted in any colour including dual colour and with a choice of glazing and hardware – see page 152–155
- FSC certified, Chain of Custody on request
- CAD drawing are available to download on our website
- For full specification details see page 80.



NEW



Beaumanor, Stone Grey

Engineering Performance

The performance of the doorset is further enhanced by the drained and vented flush glazing bead, along with the routed skin patterns that are designed to deflect the weather away from more vulnerable areas.

Construction

The new **INSULUX** external doorset range is made from an AluClassic® door blank, which has an 30mm thick insulating foam core and 100mm wide LVL (laminated veneer lumber) stiles and rails overlaid by 12.5mm AluPlex® panels giving a total depth of 55mm. Aluminium layers within the AluPlex® panels provide added stability and security to our doorsets.

Glazing

- Doubled glazed 24mm glass units
- Glazed doors on painted products utilises Q-Wood timber composite pinless beading.
- Stained glazed doors utilise timber pinned beading.

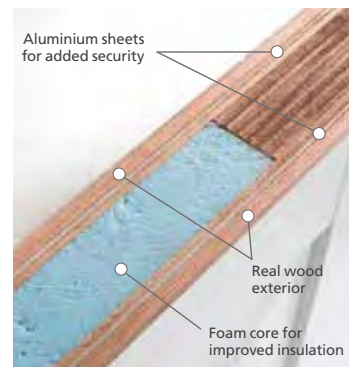

Sill detail

- Products available as standard factory finished white.
- RAL colour paint & stain and paint Dual colours are available as options.

Ventilation

No ventilation fitted.



Assistance with compliance of Approved Document M available on certain widths.



U-Value available down to: 1.2 W/m²K

SECTION DETAILS

OPEN OUT

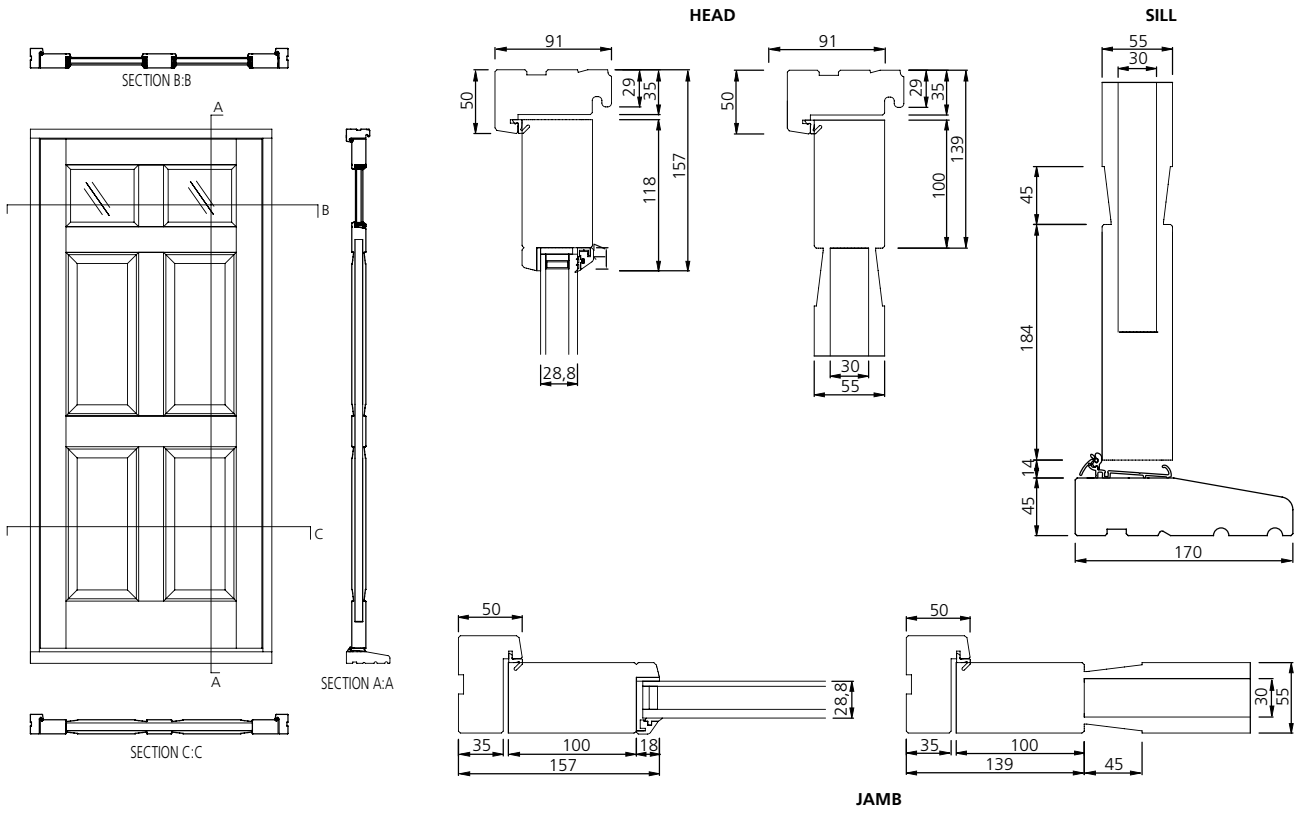

OPEN IN

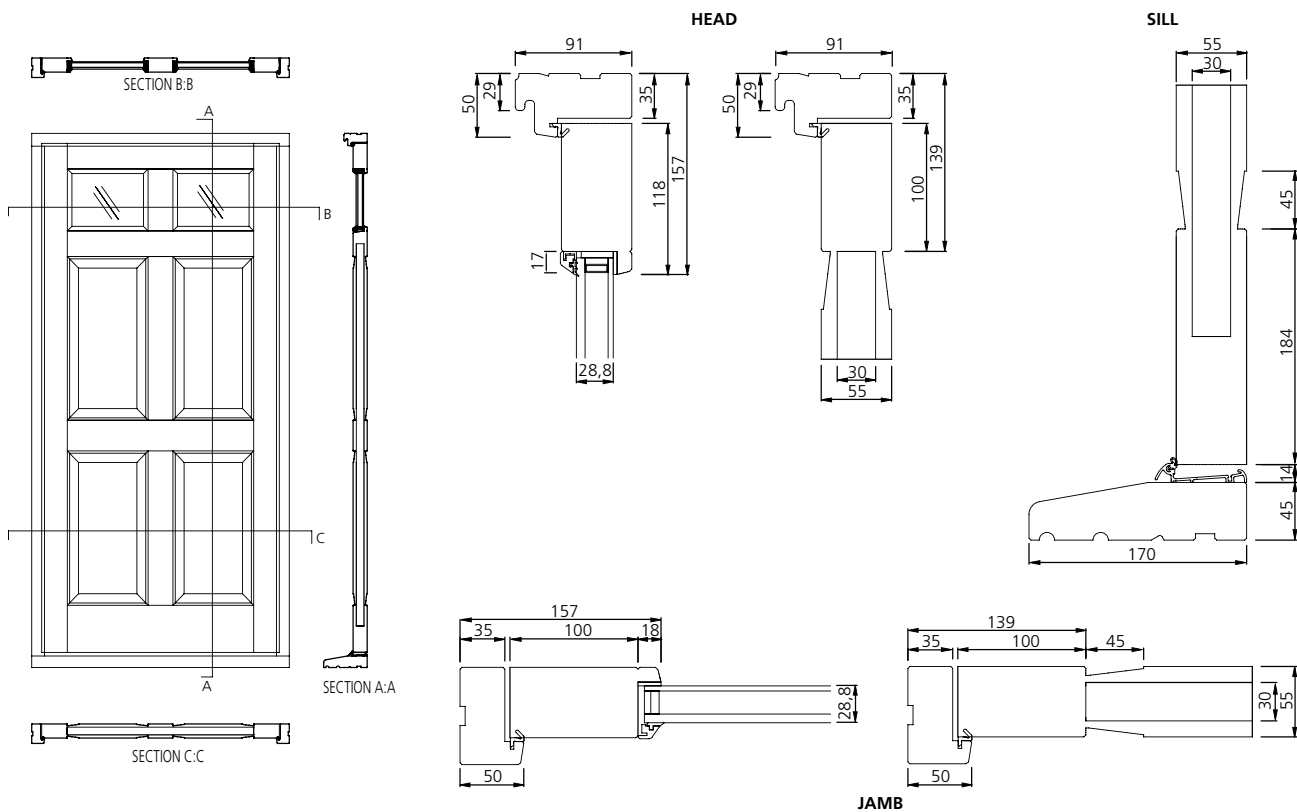

OPEN OUT/OPEN IN

MID-RAIL

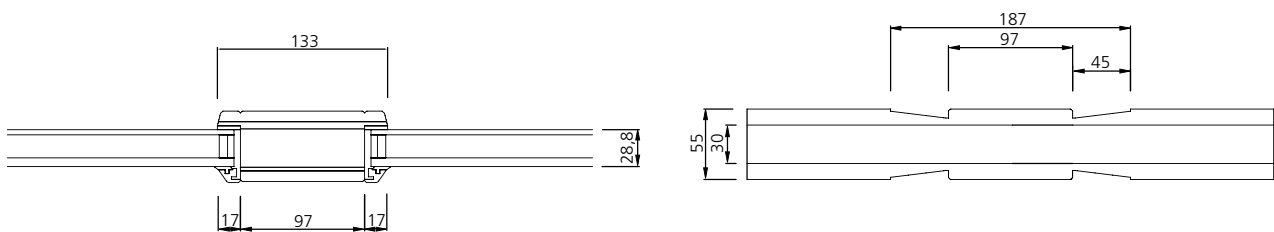
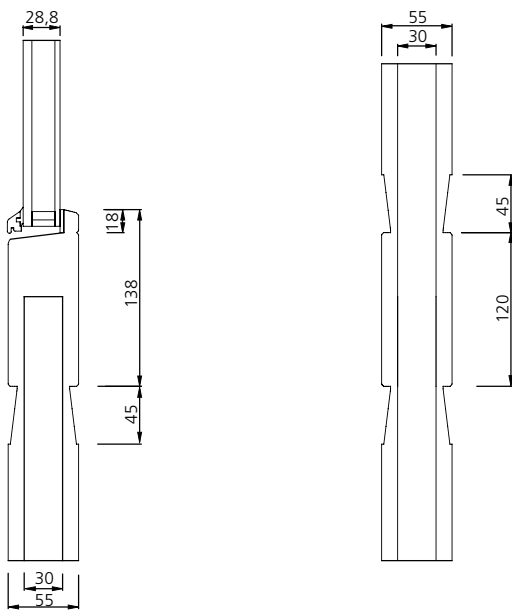

MULLION

DOORSET FRAME SIZE LIMITATIONS

INSULUX doorsets are available in the following 8 frame configurations. The table opposite shows the size options available.

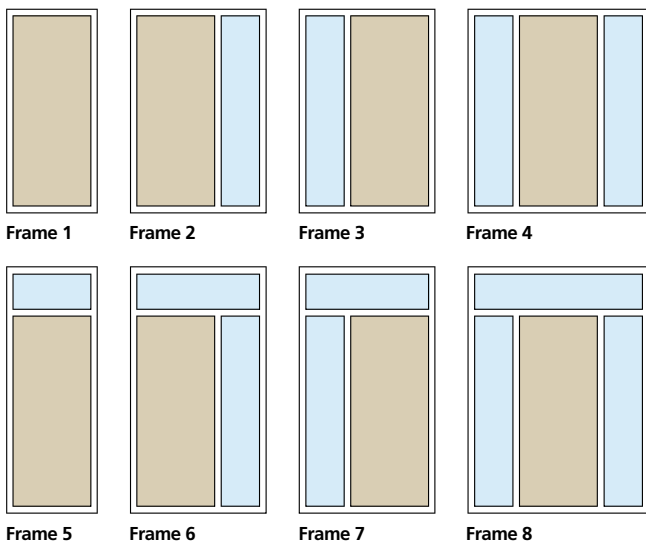

	Doorset Size (mm)	Frame Width (mm)		Frame Height (mm)	
		Min	Max	Min	Max
Frame 1	Made to measure	814	1078	1976	2395
	854x2086	854	854	2086	2086
	943x2086	943	943	2086	2086
	1006x2086	1006	1006	2086	2086
Frame 2/3	Made to measure	1111	1945	1976	2095
	854x2086	1151	1721	2086	2086
	943x2086	1240	1810	2086	2086
	1006x2086	1303	1873	2086	2086
Frame 4	Made to measure	1408	2395	1976	2095
	854x2086	1448	2395	2086	2086
	943x2086	1537	2395	2086	2086
	1006x2086	1600	2395	2086	2086
Frame 5	Made to measure	814	1078	2201	2395
	854x2086	854	854	2311	2395
	943x2086	943	943	2311	2395
	1006x2086	1006	1006	2311	2395
Frame 6/7	Made to measure	1111	1945	2201	2395
	854x2086	1151	1721	2311	2395
	943x2086	1240	1810	2311	2395
	1006x2086	1303	1873	2311	2395
Frame 8	Made to measure	1408	2395	2201	2395
	854x2086	1448	2395	2311	2395
	943x2086	1537	2395	2311	2395
	1006x2086	1600	2395	2311	2395



Osbourne



Beaumanor



Burghley



Stapleford



Longleat

Single doorset elevation details, examples based on 838mm (2'9") door.

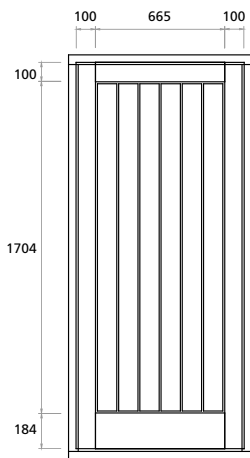

Osbourne

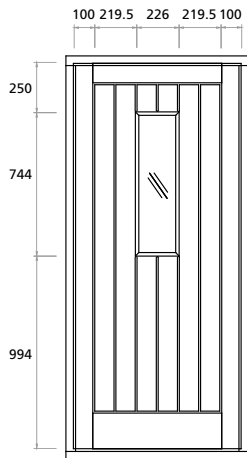

Beaumanor

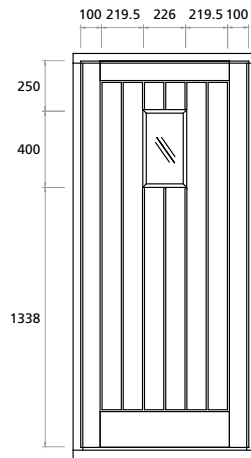

Burghley

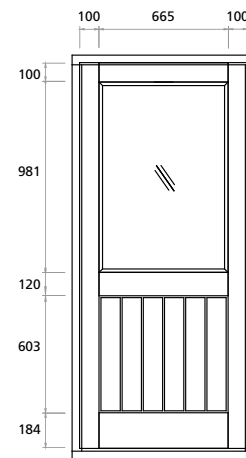

Stapleford

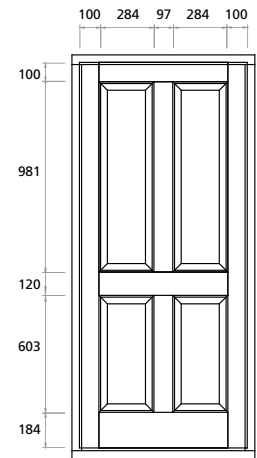

Longleat

STANDARD DOORSET CODES & U VALUES

Door design	Frame size (mm) WxH	Code	U Value (1dp)
Osbourne	854x2086	26OSB+DHFF	1.2
	943x2086	M1295OSB+DHFF	1.2
	1006x2086	30OSB+DHFF	1.2
Beaumanor	854x2086	26BMR+DHFF	1.2
	943x2086	M1295BMR+DHFF	1.2
	1006x2086	30BMR+DHFF	1.2
Burghley	854x2086	26BGH+DHFF	1.2
	943x2086	M1295BGH+DHFF	1.2
	1006x2086	30BGH+DHFF	1.2
Stapleford	854x2086	26SFD+DHFF	1.6
	943x2086	M1295SFD+DHFF	1.6
	1006x2086	30SFD+DHFF	1.6
Longleat	854x2086	26LGT+DHFF	1.2
	943x2086	M1295LGT+DHFF	1.2
	1006x2086	30LGT+DHFF	1.2
Barrington	854x2086	26BGT+DHFF	1.2
	943x2086	M1295BGT+DHFF	1.2
	1006x2086	30BGT+DHFF	1.2

Door design	Frame size (mm) WxH	Code	U Value (1dp)
Haddon	854x2086	26HDN+DHFF	1.5
	943x2086	M1295HDN+DHFF	1.5
	1006x2086	30HDN+DHFF	1.5
Stanford	854x2086	26SAF+DHFF	1.6
	943x2086	M1295SAF+DHFF	1.6
	1006x2086	30SAF+DHFF	1.6





Barrington



Haddon



Stanford

Single doorset elevation details, examples based on 838mm (2'9") door.

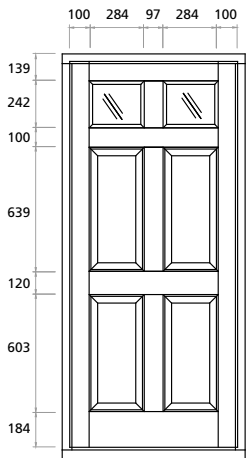

Barrington

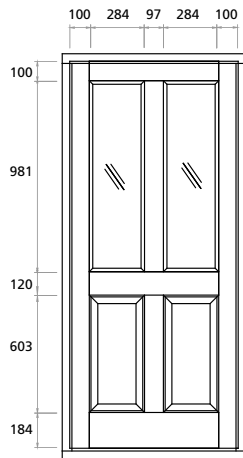

Haddon

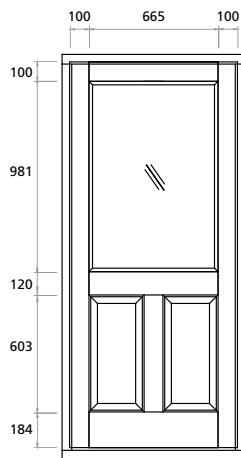

Stanford

CASTLE

COMPOSITE DOORSETS



A high quality composite door manufactured from fibreglass, with a woodgrain finish to give a natural look of real timber. The thermoset manufacturing process means the panel will not expand or contract with changing temperature, ensuring this door offers long lasting performance. Composite doorsets are extremely energy efficient and the doors don't require decorating, saving future maintenance costs.

- High impact-resistant, thermoset, GRP (Glass Reinforced Polyester) skins with woodgrain effect
- U values down to 1.0 W/m²K for the doorset
- 44mm thick pre-hung door leaf in a white painted softwood frame with hardwood and oak optional
- 170mm hardwood sill as standard with 140mm or 25mm low level threshold options available
- Standard sizes and made to measure options, FD30 fire doors available
- Available left or right hand hung, open in or out
- Choice of 7 exterior colours with white interior
- PAS 24 specification options available to meet the requirements of Approved Document Q and Secured by Design
- Hardex polished chrome inline handles with ERA Vectis multi-point key/key locking system as standard, key/thumb-turn options available
- Side light and top light options available
- 943mm doorset width and above comply with Approved Document M
- Factory glazed windows are CE Marked
- FSC certified, Chain of Custody on request
- CAD drawings are available to download on our website
- For full specification details see page 80.



NEW
DESIGNS



Richmond,
Black

Technical information

- Engineered composite rails and stiles which completely seal the insulating core
- Polyurethane core is 100% CFC-free and offers enhanced sound and heat insulation Global warming potential: <5
- Ozone depletion potential: 0
- Door leaf weight 25 kg (approx.)
- Glazed doors utilise a unique snap together action cassette eliminating unsightly plugs and screws

Glazing

- Factory glazed options supplied with Cotswold™ glass as standard
- 24mm Glass unit
- 6.8mm laminated outer pane / 4mm toughened inner pane
- 14.5mm black spacer bar

Colours

- Doors supplied with white on interior and exterior as standard
- Colours shown available to choose for exterior door faces
- Reeve doorset is only available in stained golden oak, rosewood and white
- Doors supplied white inside

Doorsets come in 7 exterior colours with a white interior finish:

Through colours

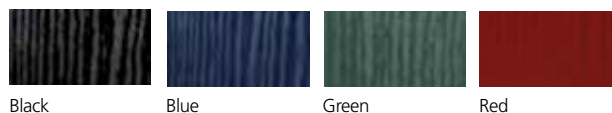

Black

Blue

Green

Red

Stained effect



White

Golden Oak

Rosewood



Assistance with compliance of Approved Document M available on certain widths.



U-Value available down to: 1.1 W/m²K



Lincoln



York



Oxford



Belvoir



Howard

Single doorset elevation details, examples based on 838mm (2'9") door.

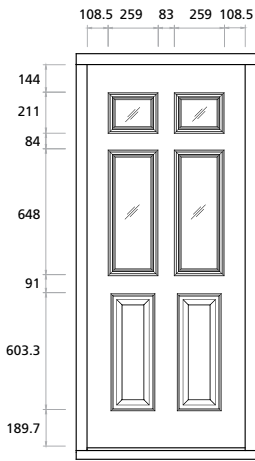

Lincoln

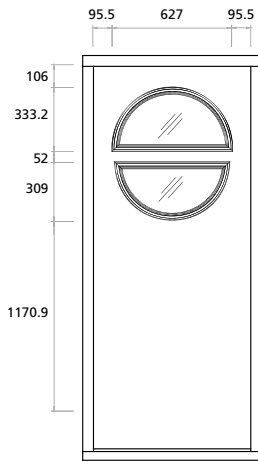

York

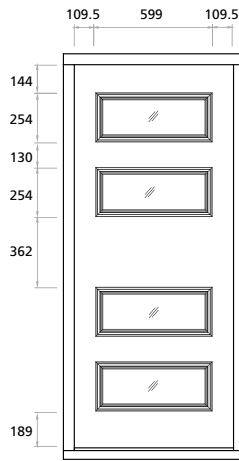

Oxford

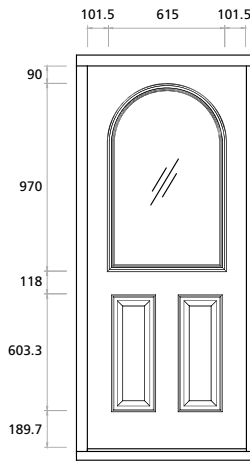

Belvoir

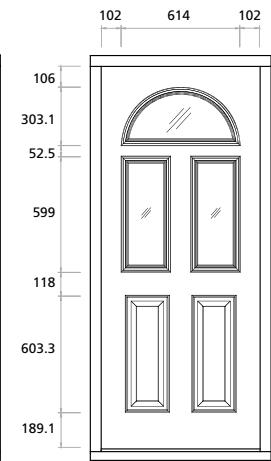

Howard

DOORSET FRAME SIZE LIMITATIONS

Castle doorsets are available in the following configurations. The table opposite shows the size options available.

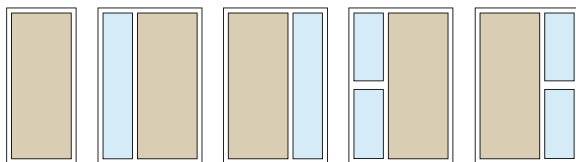

Frame 1 Frame 2 Frame 3 Frame 4 Frame 5

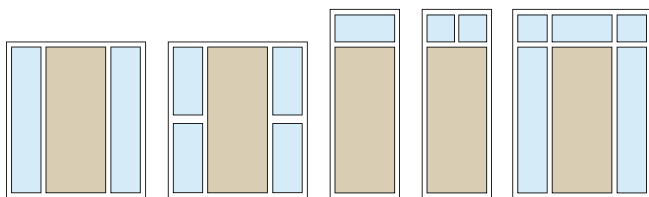

Frame 6 Frame 7 Frame 8 Frame 9 Frame 10

	Doorset Size (mm)	Frame Width (mm)		Frame Height (mm)	
		Min	Max	Min	Max
Frame 1	Made to measure	814	1006	2008	2118
	854x2086	854	854	2086	2086
	943x2086	943	943	2086	2086
	1006x2086	1006	1006	2086	2086
Frame 2	Made to measure	1039	1871	2008	2118
	854x2086	1119	1719	2086	2118
	943x2086	1195	1795	2086	2118
	1006x2086	1271	1871	2086	2118
Frame 6 / 7	Made to measure	1489	2171	2008	2118
	854x2086	1569	2019	2086	2118
	943x2086	1645	2095	2086	2118
	1006x2086	1721	2171	2086	2118
Frame 8 / 9	Made to measure	814	1006	2190	2395
	854x2086	854	854	2395	2395
	943x2086	943	943	2395	2395
	1006x2086	1006	1006	2395	2395
Frame 10	Made to measure	1489	2171	2190	2395
	854x2086	1569	2019	2395	2395
	943x2086	1645	2095	2395	2395
	1006x2086	1721	2171	2395	2395



Lincoln



Canterbury



Richmond



Hylton



Reeve

Single doorset elevation details, examples based on 838mm (2'9") door.

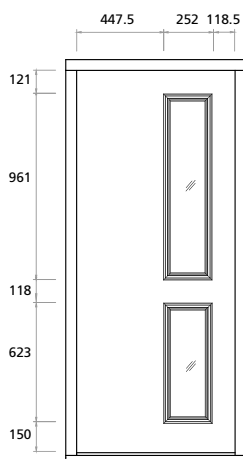

Farleigh

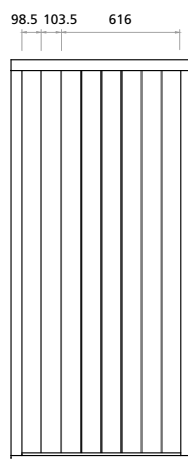

Canterbury

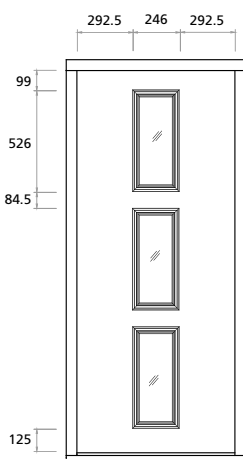

Richmond

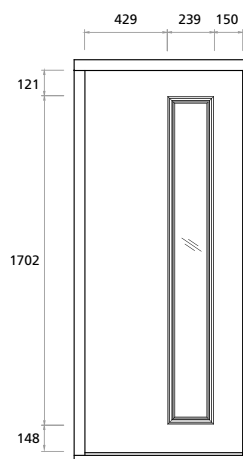

Hylton

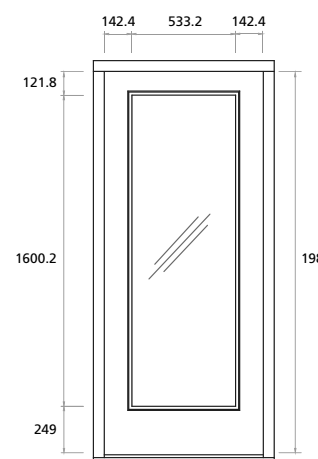

Reeve

STANDARD DOORSET CODES & U VALUES



Door design	Frame size (mm) WxH	Code	U Value (1dp)
Lincoln	854x2086	26LCO+DSFF	1.1
	943x2086	M1295LCO+DSFF	1.1
	1006x2086	30LCO+DSFF	1.1
York	854x2086	26YRK+DSFF	1.1
	943x2086	M1295YRK+DSFF	1.1
	1006x2086	30YRK+DSFF	1.1
Oxford	854x2086	26OXF+DSFF	1.1
	943x2086	M1295OXF+DSFF	1.1
	1006x2086	30OXF+DSFF	1.1
Belvoir	854x2086	26BVR+DSFF	1.2
	943x2086	M1295BVR+DSFF	1.2
	1006x2086	30BVR+DSFF	1.2
Howard	854x2086	26RHDC+DSFF	1.1
	943x2086	M1295RHDC+DSFF	1.1
	1006x2086	30RHDC+DSFF	1.1

Door design	Frame size (mm) WxH	Code	U Value (1dp)
Farleigh	854x2086	26FARR+DSFF	1.1
	943x2086	M1295FARR+DSFF	1.1
	1006x2086	30FARR+DSFF	1.1
Canterbury	854x2086	26CAY+DSFF	1.0
	943x2086	M1295CAY+DSFF	1.0
	1006x2086	30CAY+DSFF	1.0
Richmond	854x2086	26RHDC+DSFF	1.1
	943x2086	M1295RHDC+DSFF	1.1
	1006x2086	30RHDC+DSFF	1.1
Hylton	854x2086	26HYNR+DSFF	1.1
	943x2086	M1295HYNR+DSFF	1.1
	1006x2086	30HYNR+DSFF	1.1
Reeve	854x2086	26RVE+DSFF	1.2
	943x2086	M1295RVE+DSFF	1.2
	1006x2086	30RVE+DSFF	1.2



Barnard



Clifford



Cottage



Dunster



Keep

Single doorset elevation details, examples based on 838mm (2'9") door.

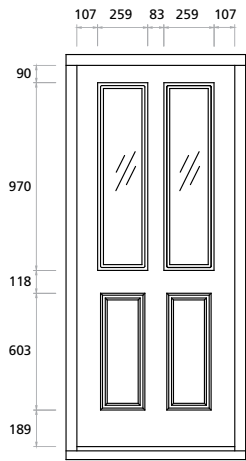

Barnard

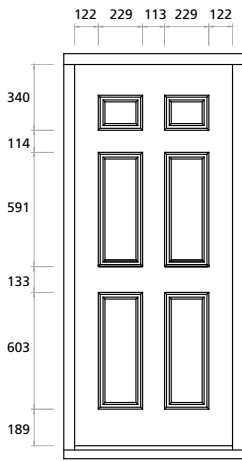

Clifford

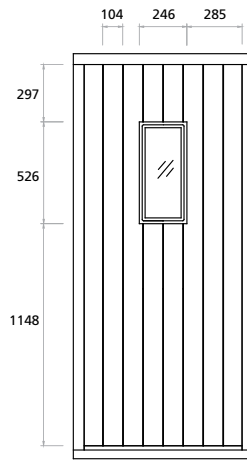

Cottage

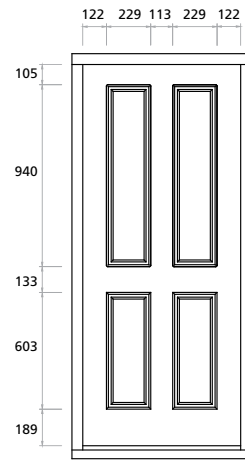

Dunster

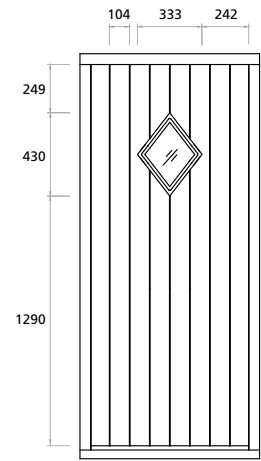

Keep

DOORSET FRAME SIZE LIMITATIONS

Castle doorsets are available in the following configurations. The table opposite shows the size options available.

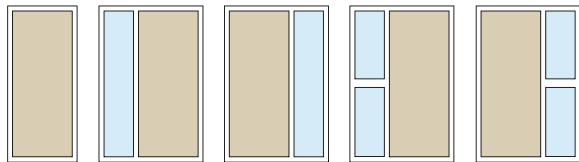

Frame 1 Frame 2 Frame 3 Frame 4 Frame 5

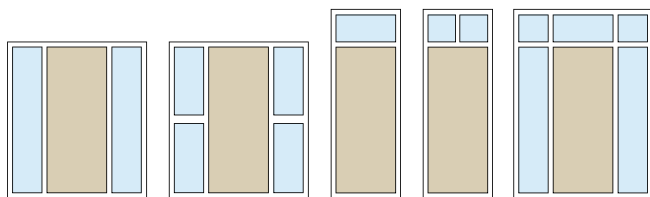

Frame 6 Frame 7 Frame 8 Frame 9 Frame 10

	Doorset Size (mm)	Frame Width (mm)		Frame Height (mm)	
		Min	Max	Min	Max
Frame 1	Made to measure	814	1006	2008	2118
	854x2086	854	854	2086	2086
	943x2086	943	943	2086	2086
	1006x2086	1006	1006	2086	2086
Frame 2	Made to measure	1039	1871	2008	2118
	854x2086	1119	1719	2086	2118
	943x2086	1195	1795	2086	2118
	1006x2086	1271	1871	2086	2118
Frame 6 / 7	Made to measure	1489	2171	2008	2118
	854x2086	1569	2019	2086	2118
	943x2086	1645	2095	2086	2118
	1006x2086	1721	2171	2086	2118
Frame 8 / 9	Made to measure	814	1006	2190	2395
	854x2086	854	854	2395	2395
	943x2086	943	943	2395	2395
	1006x2086	1006	1006	2395	2395
Frame 10	Made to measure	1489	2171	2190	2395
	854x2086	1569	2019	2395	2395
	943x2086	1645	2095	2395	2395
	1006x2086	1721	2171	2395	2395



Leeds



Rising



Tilsbury



Upnor



Walden

Single doorset elevation details, examples based on 838mm (2'9") door.

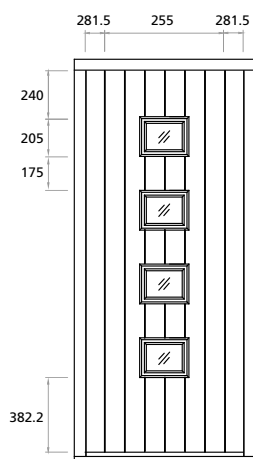

Leeds

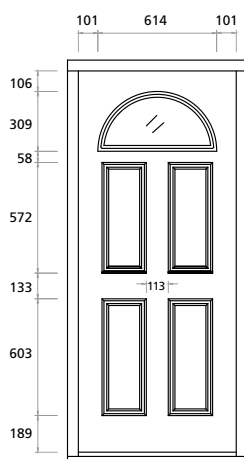

Rising

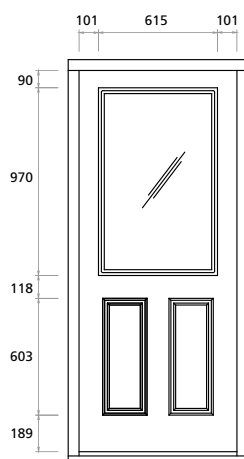

Tilsbury

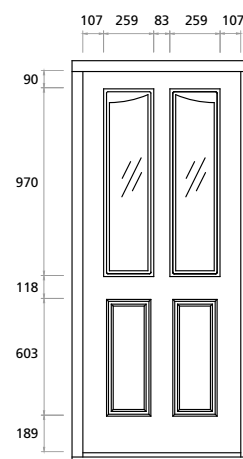

Upnor

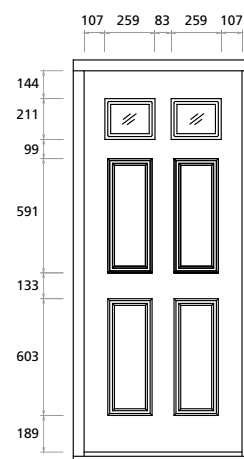

Walden

STANDARD DOORSET CODES & U VALUES



Door design	Frame size (mm) WxH	Code	U Value (1dp)
Barnard	854x2086	26BND+DSFF	1.1
	943x2086	M1295BND+DSFF	1.1
	1006x2086	30BND+DSFF	1.1
Clifford	854x2086	26CFD+DSFF	1.0
	943x2086	M1295CFD+DSFF	1.0
	1006x2086	30CFD+DSFF	1.0
Cottage	854x2086	26COT+DSFF	1.0
	943x2086	M1295COT+DSFF	1.0
	1006x2086	30COT+DSFF	1.0
Dunster	854x2086	26DTR+DSFF	1.0
	943x2086	M1295DTR+DSFF	1.0
	1006x2086	30DTR+DSFF	1.0
Keep	854x2086	26KEP+DSFF	1.0
	943x2086	M1295KEP+DSFF	1.0
	1006x2086	30KEP+DSFF	1.0
Leeds	854x2086	26LEE+DSFF	1.0
	943x2086	M1295LEE+DSFF	1.0
	1006x2086	30LEE+DSFF	1.0

Door design	Frame size (mm) WxH	Code	U Value (1dp)
Upnor	854x2086	26UPR+DSFF	1.1
	943x2086	M1295UPR+DSFF	1.1
	1006x2086	30UPR+DSFF	1.1
Rising	854x2086	26RSG+DSFF	1.0
	943x2086	M1295RSG+DSFF	1.0
	1006x2086	30RSG+DSFF	1.0
Tilsbury	854x2086	26TBY+DSFF	1.2
	943x2086	M1295TBY+DSFF	1.2
	1006x2086	30TBY+DSFF	1.2
Walden	854x2086	26WDN+DSFF	1.0
	943x2086	M1295WDN+DSFF	1.0
	1006x2086	30WDN+DSFF	1.0

CASTLE

COMPOSITE FIRE DOORSETS



Our FD30 Castle composite fire doorsets provide 30 minutes' fire resistance and are available in a range of popular woodgrain designs and colours.

- High impact-resistant, thermoset, GRP (Glass Reinforced Polyester) skins
- U values down to 1.5 W/m²K for the doorset
- 44mm thick pre-hung fire doorset in a white painted softwood frame
- FD30 fire resistant frame with 170mm hardwood sill and deflector bar
- Standard sizes and made to measure options
- Available left or right hand hung, open in or out
- Choice of 5 exterior colours for the outer face with white on the interior – Oak and Rosewood not available on fire doorsets
- PAS 24 specification options available to meet the requirements of Approved Document Q and Secured by Design
- Hardex polished chrome inline handles with thumb-turn lock supplied loose for fitting on site
- 943mm doorset width and above comply with Approved Document M
- Tested and approved to EN 1634-1 – a global assessment
- Factory glazed windows are CE Marked
- FSC certified, Chain of Custody on request
- CAD drawings are available to download on our website
- For full specification details see page 80.



NEW
DESIGNS



Walden,
Black

Technical information

- Engineered composite rails and stiles which completely seal the insulating core
- Polyurethane core is 100% CFC-free and offers enhanced sound and heat insulation Global warming potential: <5
- Ozone depletion potential: 0
- Door leaf weight 25 kg (approx.)
- Glazed doors utilise a unique snap together action cassette eliminating unsightly plugs and screws

Glazing

- Factory glazed options supplied with Cotswold™ glass as standard
- 24mm Glass unit
- 6.8mm laminated outer pane / 4mm toughened inner pane
- 14.5mm black spacer bar



Assistance with compliance of Approved Document M available on certain widths.



U-Value available down to: 1.1 W/m²K

Colours

- Doors supplied with white on interior and exterior as standard
- Colours shown available to choose for exterior door faces
- Reeve doorset is only available in stained golden oak, rosewood and white
- Doors supplied white inside

Doorsets come in 5 exterior colours with a white interior finish:

Through colours



Black Blue Green Red White

DOORSET SIZE LIMITATIONS



Frame 1

	Doorset Size (mm)	Frame Width (mm)		Frame Height (mm)	
		Min	Max	Min	Max
Frame 1	Made to measure	814	1006	2008	2118
	854x2086	854	854	2086	2086
	943x2086	943	943	2086	2086
	1006x2086	1006	1006	2086	2086



Lincoln

Oxford

Arundel

Dover

Rochester

Single doorset elevation details, examples based on 838mm (2'9") door.

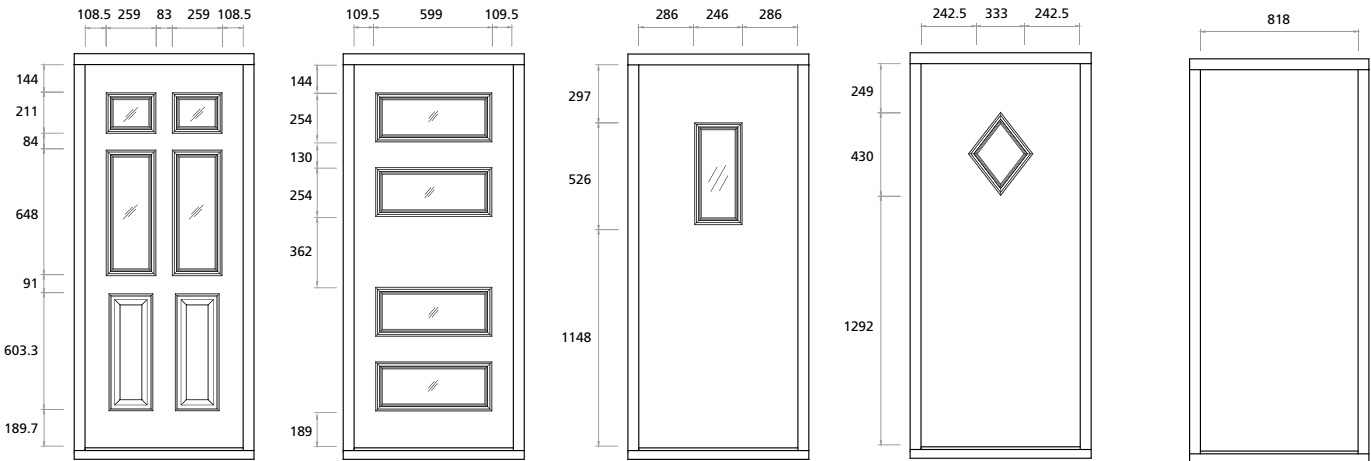

Lincoln

Oxford

Arundel

Dover

Rochester

STANDARD DOORSET CODES & U VALUES

Door design	Frame size (mm) WxH	Code	U Value (1dp)	Door design	Frame size (mm) WxH	Code	U Value (1dp)
Lincoln	854x2086	FD-26LCO+DSFF	2.0	Clifford	854x2086	FD-26CFD+DSFF	1.5
	930x2086	FD-29LCO+DSFF	2.0		930x2086	FD-29CFD+DSFF	1.5
	1006x2086	FD-30LCO+DSFF	2.0		1006x2086	FD-30CFD+DSFF	1.5
Oxford	854x2086	FD-26OXF+DSFF	2.0	Barnard	854x2086	FD-26BND+DSFF	2.0
	930x2086	FD-29OXF+DSFF	2.0		930x2086	FD-29BND+DSFF	2.0
	1006x2086	FD-30OXF+DSFF	2.0		1006x2086	FD-30BND+DSFF	2.0
Arundel	854x2086	FD-26ADL+DSFF	1.5	Upnor	854x2086	FD-26UPR+DSFF	2.0
	930x2086	FD-29ADL+DSFF	1.5		930x2086	FD-29UPR+DSFF	2.0
	1006x2086	FD-30ADL+DSFF	1.5		1006x2086	FD-30UPR+DSFF	2.0
Dover	854x2086	FD-26DVR+DSFF	1.5	Walden	854x2086	FD-26WDN+DSFF	1.5
	930x2086	FD-29DVR+DSFF	1.5		930x2086	FD-29WDN+DSFF	1.5
	1006x2086	FD-30DVR+DSFF	1.5		1006x2086	FD-30WDN+DSFF	1.5
Rochester	854x2086	FD-26RTR+DSFF	1.5	Rising	854x2086	FD-26RSG+DSFF	1.5
	930x2086	FD-29RTR+DSFF	1.5		930x2086	FD-29RSG+DSFF	1.5
	1006x2086	FD-30RTR+DSFF	1.5		1006x2086	FD-30RSG+DSFF	1.5
Dunster	854x2086	FD-26DTR+DSFF	1.5	Tilsbury	854x2086	FD-26TBY+DSFF	2.5
	930x2086	FD-29DTR+DSFF	1.5		930x2086	FD-29TBY+DSFF	2.5
	1006x2086	FD-30DTR+DSFF	1.5		1006x2086	FD-30TBY+DSFF	2.5



Dunster



Clifford



Barnard



Upnor



Walden



Dunster

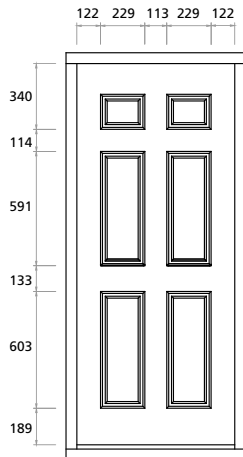

Clifford

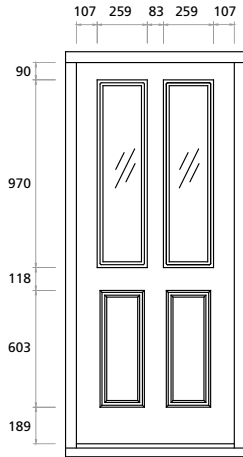

Barnard

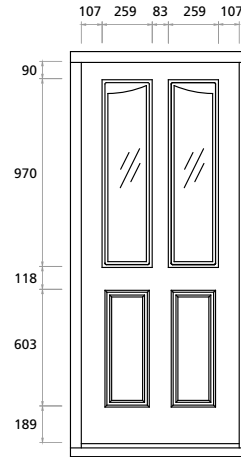

Upnor

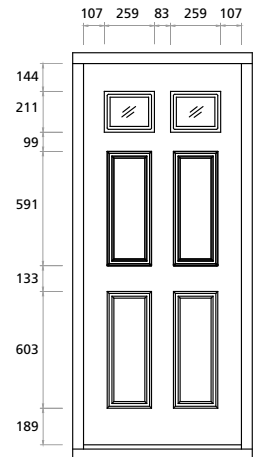

Walden



Rising

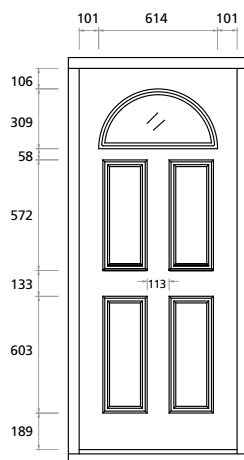

Rising



Tilsbury

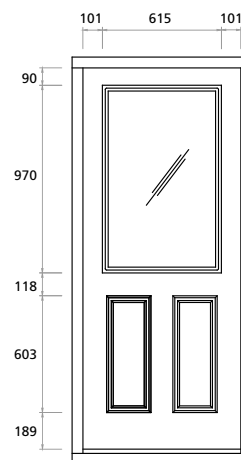

Tilsbury



DREAMVU™ HIGH PERFORMANCE

SOFTWOOD, SINGLE DOORSET



This softwood high performance doorset offers ultimate weather resistance and security.

- U values available 1.1 -1.5 W/m²K
- 28mm double or triple glazing with black warm edge spacer bar. Laminated outer pane as standard
- Standard and made to measure sizes available with glazing bar design options
- 64mm thick door leaves that are available left or right hand hung, with open in or out options
- Hardex polished chrome handles and locking system from ERA's Fortress Vectis Plus range, using a traditional 5 lever mortice lock technology with cylinder-free multi-point locking, see page 154 for other colour options
- PAS 3621:2011 / PAS 8621:2011 multi-point lock PAS 24 specification as standard, meeting the requirements of Approved Document Q and Secured by Design
- 964mm doorset width and above comply with Approved Document M
- Painted in any colour including dual colour with a choice of glazing and hardware – see page 152–155
- Pinless beading on factory painted and glazed doorsets
- Low level aluminium sill depth of 120mm for open out and 117mm for open in
- Overall frame size quoted
- Factory glazed doorsets are CE Marked
- FSC certified, Chain of Custody on request
- CAD drawings are available to download on our website
- For full specification details see page 80.





Glazing

Using glazing rebates of 18mm x 53mm, our High Performance DreamVu™ single doorsets will accept either double or triple glazed units. The glazing system is fully drained and vented with a sloping bottom platform. A full 5mm clearance is provided between the insulating glass unit and rebate, in compliance with BS 6262.

Ventilation

The DreamVu™ doorset is supplied as standard without any trickle ventilation installed. This is due to the nature of the developments it is more commonly specified in, such as buildings incorporating heat recovery systems.

Sill Detail

A standard aluminium sill provides a projection of 102mm for open in and 104mm for open out. Care must be taken to ensure that the sill width is suitable for the specified building in detail whilst achieving compliance with Approved Document L, and to allow for internal sill drainage to clear the brickwork. An internal ramp is available if required to achieve compliance with Approved Document M.



Assistance with compliance of Approved Document M available on certain widths.



dB reductions up to: 34dB



U-Value available down to: 1.1 W/m²K

SINGLE DOORSET SECTION DETAILS

OPEN OUT

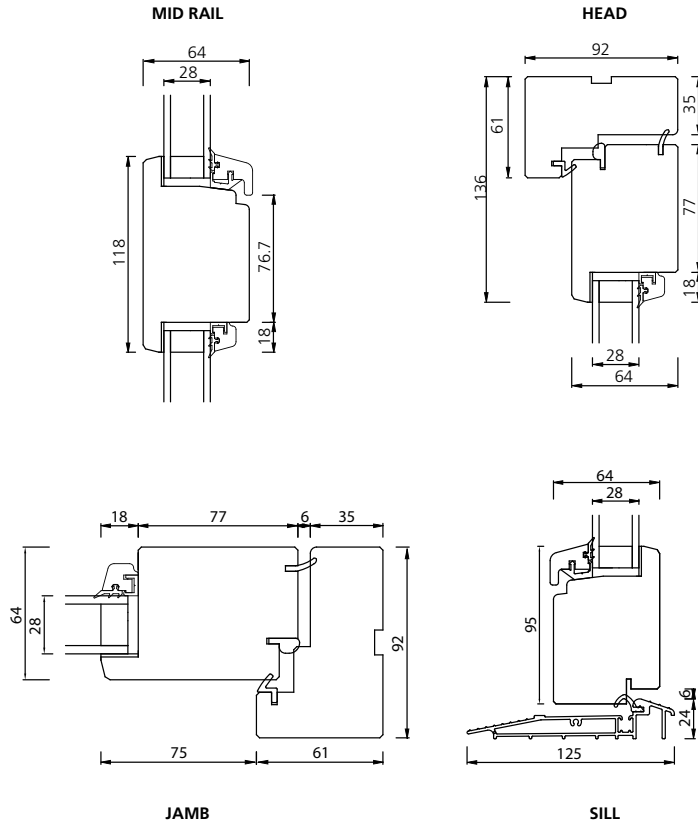
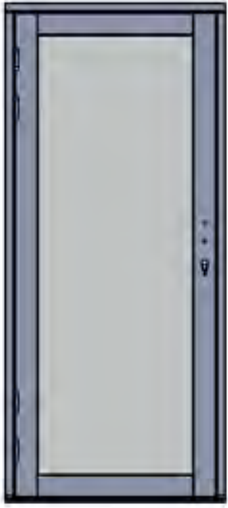

OPEN IN

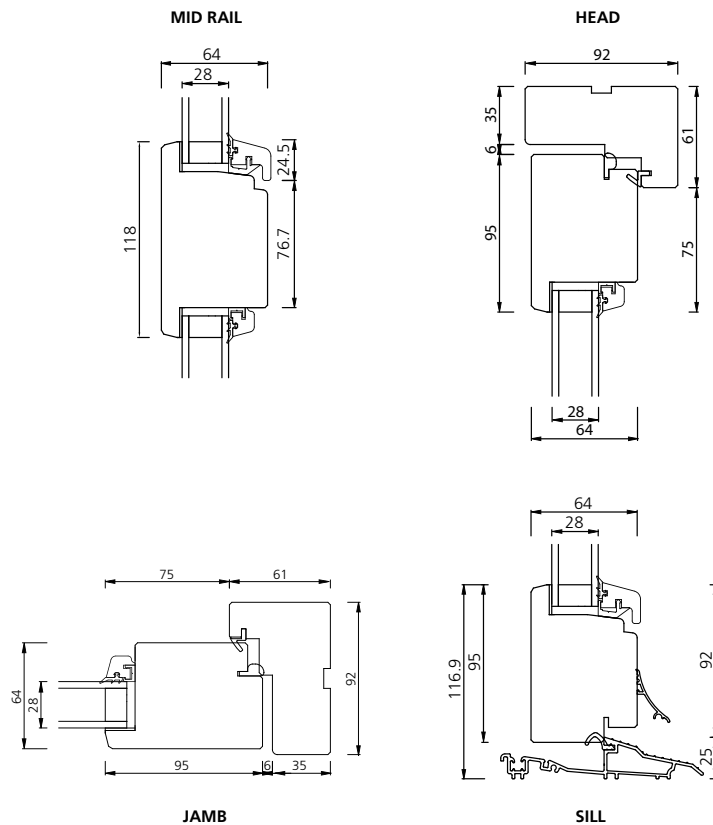
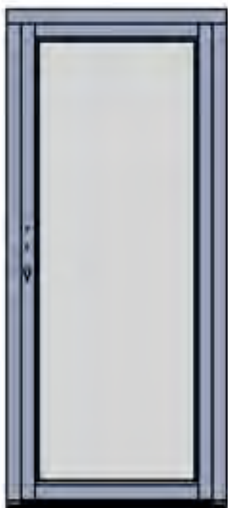

SIZE LIMITATIONS

Our DreamVu™ Doorset range is available as standard sizes or made to measure. When specifying made to measure products, the below limitations should be used as a guide to what can be manufactured.

Range	Min Frame Width (mm)	Min Frame Height (mm)	Max Frame Width (mm)	Max Frame Height (mm)
Single doorset	588	1758	988	2238*
Side lights	450	1758	988	2238*

* PAS 24 available on door heights up to 2100mm

Please note, configuration limitations vary within the min/max dimensions due to weight and sash proportions. For further detailed sizing please contact our estimating department on 0845 122 2892.

ACOUSTIC PERFORMANCE

External noise reduction is required from various different sources. These can either be road traffic, air traffic, rail or pedestrians. Depending on the different sources, certain frequencies will be relatively higher which results in a significant reduction required for this specific band of frequency. These tables detail these bands, which will enable you to see the exact performance of the product.

DreamVu™ Doorset Standard glass
4-12-4-12-4

Freq F HZ	Sound Reduction Index, dB	
	1/3 Octave	1/1 Octave
100	22.6	20.3
125	19.5	
160	18.7	
200	24.1	22.1
250	20.8	
315	21.5	
400	25.3	
500	31.7	30.1
630	33.2	
800	35.7	35.9
1000	35.5	
1250	36.6	
1600	38.3	
2000	37.9	37.1
2500	35.2	
3150	31.2	33.7
4000	33.7	
5000	36.3	

DreamVu™ Doorset Acoustic glass
6-16-6.4 Acoustic Glass

Freq F HZ	Sound Reduction Index, dB	
	1/3 Octave	1/1 Octave
100	22.8	19.9
125	21.1	
160	15.7	
200	23.8	25.4
250	26.1	
315	26.3	
400	31.4	
500	33.8	33.5
630	35.2	
800	36.5	36.0
1000	36.1	
1250	35.4	
1600	35.9	
2000	34.0	34.9
2500	34.7	
3150	38.4	39.0
4000	39.5	
5000	39.2	

FARNDALE

SOFTWOOD, SINGLE DOORSET



The Farndale French doorset feature an attractive, contemporary design, with slim timber sections to maximise the glazed area. Available made to measure in a variety of designs.

- U values available 1.1-1.6 W/m²K
- 28mm double or triple glazing with black warm edge spacer bar
- 54mm softwood door leaves that open in or out
- Hardex polished chrome handles and locking system from ERA's Vectis Plus Fortress range, using a traditional 5 lever mortice lock technology with cylinder-free multi-point locking, see page 154 for other options
- Standard and made to measure sizes, top and side light options
- CAD drawings are available to download on our website
- Various designs to choose from. Bottom panel designs will be supplied with flat panels
- Right hand opens first as viewed from the outside
- Base coat stained as standard. Factory finished option Hi-Build white as standard. Other colour options available, see page 152.
- Factory glazed doorsets are CE Marked
- FSC certified, Chain of Custody on request
- Special widths are available to order. 300mm side lights will be supplied with horizontal bars only as standard. If you require any other design, please specify at time of ordering
- Pinless beading on factory paint finished and glazed doorsets
- For full specification details see page 80.





PATT 2XG

Glazing

Using glazing rebates of 18mm x 43mm, our Farndale single doorsets will accept 28mm (4:20:4) insulating glass units as standard. The glazing system is fully drained and vented with a sloping bottom platform. A full 5mm clearance is provided between the insulating glass unit and rebate, in compliance with BS 6262.

Ventilation

Flush fitting ventilators are supplied fitted as standard to all Farndale doorsets to assist in compliance with Approved Document F of the Building Regulations. These provide an Equivalent Area of 8970mm² for double doorsets and 4485mm² for single doorsets. This product is also available with no trickle ventilation at time of order.

Sill Detail

A standard timber sill provides a projection of 170mm, with an aluminium threshold fixed to the sill to assist with drainage and compliance with Approved Document M. Care must be taken to ensure that the sill width is suitable for the specified building in detail whilst achieving compliance with Approved Document L, and to allow for internal sill drainage to clear the brickwork.



Assistance with compliance of Approved Document M available on certain widths.



dB reductions up to: 31dB



U-Value available down to: 1.1 Wm²K



Background ventilation provided, to assist with compliance of Approved Document F

SINGLE DOORSET SECTION DETAILS

OPEN IN

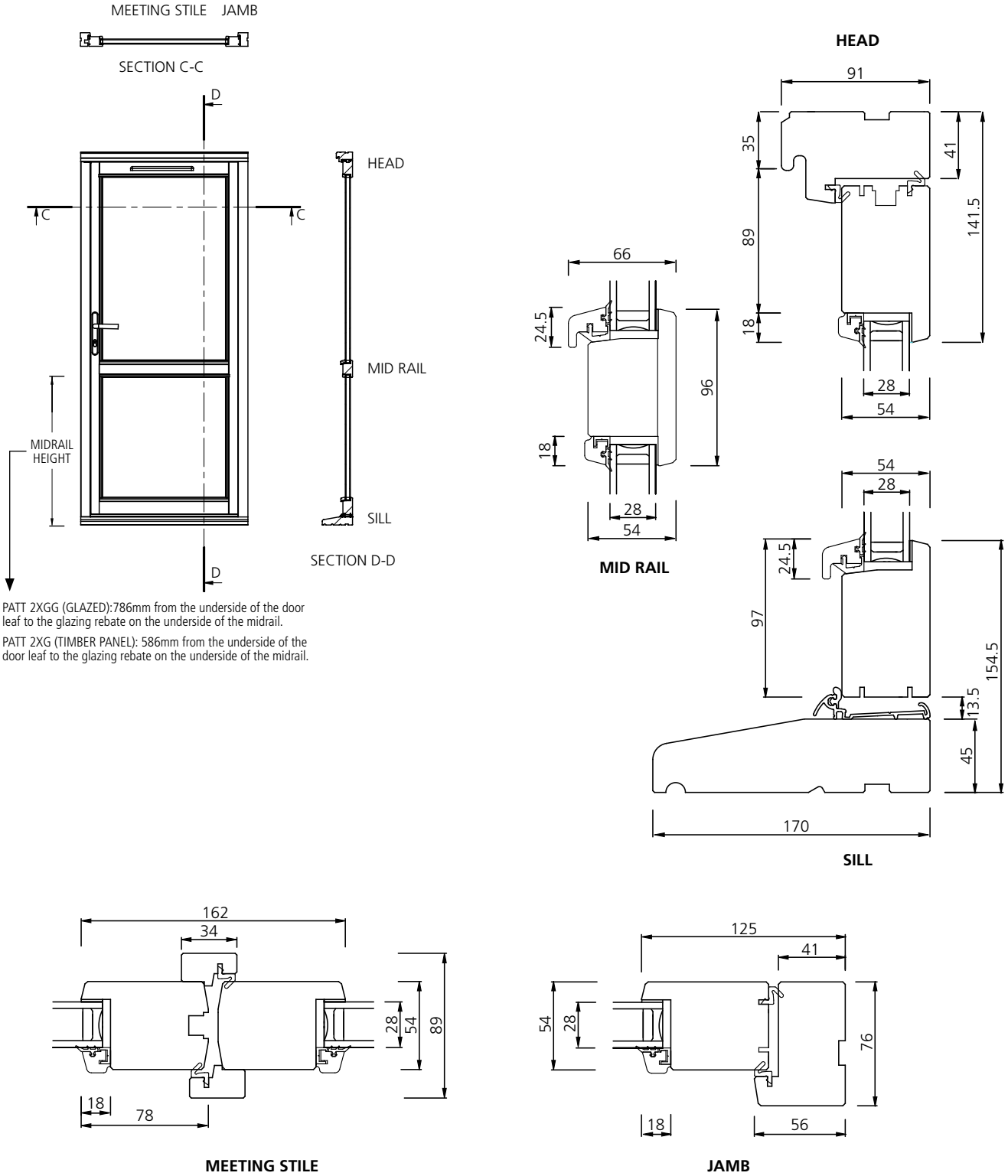

OPEN OUT

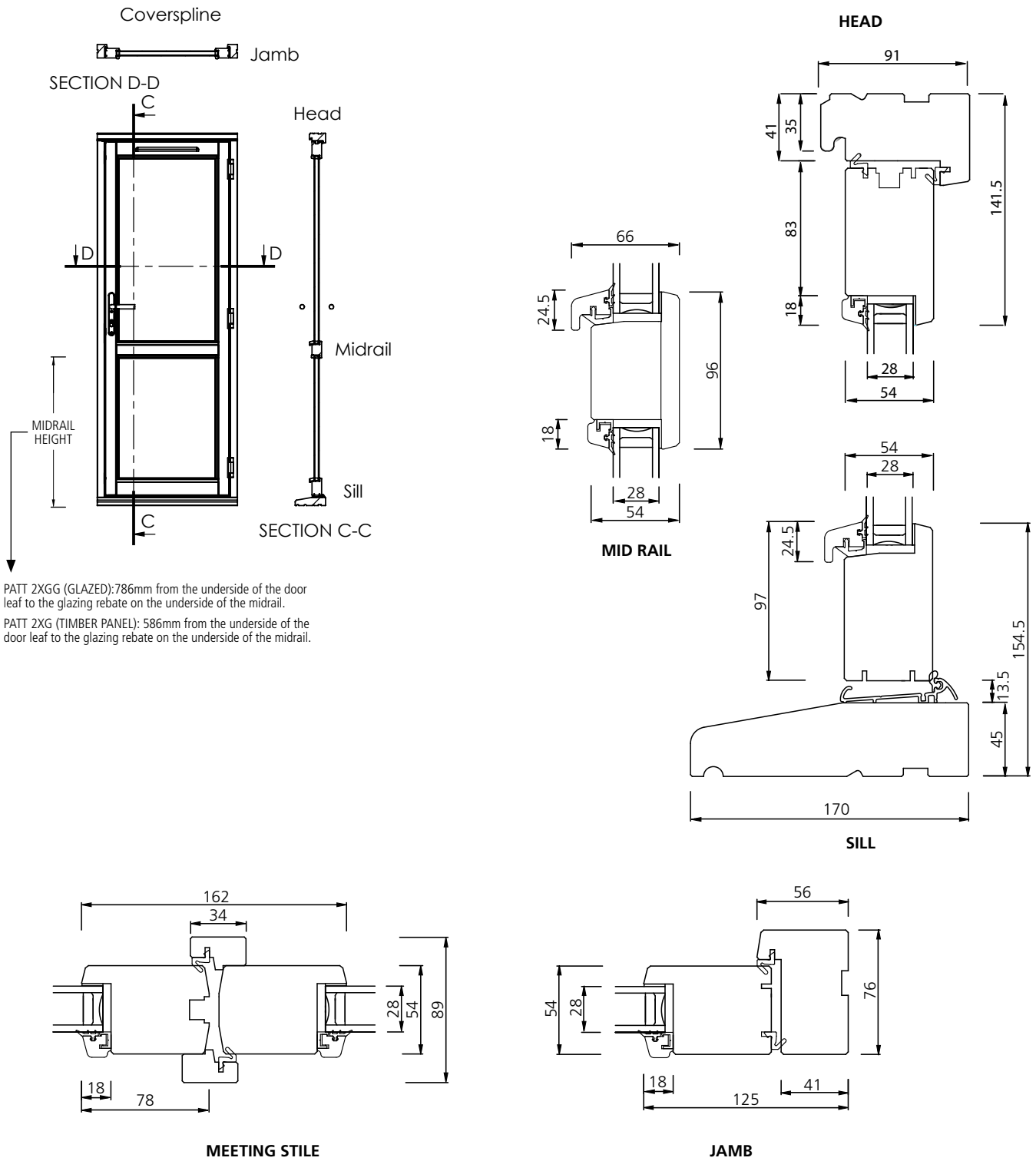

SIZE LIMITATIONS

Our Farndale doorset range is available as standard sizes or made to measure. When specifying made to measure products, the below limitations should be used as a guide to what can be manufactured.

Range	Min Frame Width (mm)	Min Frame Height (mm)	Max Frame Width (mm)	Max Frame Height (mm)
Single doorset	588*	1758**	1018	2238
Side lights	350*	1758**	600	2238

* Any leaf below 500mm has no restrictors or trickle vents

** PAS 24 not available on frame heights less than 1800mm and/or greater than 2088mm

Please note, configuration limitations vary within the min/max dimensions due to weight and sash proportions. For further detailed sizing please contact our estimating department on 0845 1222892.

ACOUSTIC PERFORMANCE

External noise reduction is required from various different sources. These can either be road traffic, air traffic, rail or pedestrians. Depending on the different sources, certain frequencies will be relatively higher which results in a significant reduction required for this specific band of frequency. These tables detail these bands, which will enable you to see the exact performance of the product.

Farndale Standard glass

4-20-4

Freq F HZ	Sound Reduction Index, dB	
	1/3 Octave	1/1 Octave
100	20.6	20.5
125	21.1	
160	19.9	
200	20.7	19.6
250	16.2	
315	22.0	
400	24.1	
500	28.2	27.4
630	29.9	
800	31.8	
1000	31.3	31.4
1250	31.0	
1600	33.1	34.9
2000	36.5	
2500	35.1	
3150	30.1	
4000	32.3	32.5
5000	35.2	

Rating according to BS EN ISO 717-1:1997
RW (C;Ctr) = 30 (-1;-4) dB

Farndale Acoustic glass

6-16-6.4

Freq F HZ	Sound Reduction Index, dB	
	1/3 Octave	1/1 Octave
100	20.9	20.7
125	20.9	
160	20.3	
200	20.8	19.7
250	16.4	
315	21.8	
400	24.4	
500	28.7	27.7
630	30.1	
800	32.3	
1000	32.5	32.6
1250	32.9	
1600	35.7	37.0
2000	38.9	
2500	36.4	
3150	31.3	
4000	35.7	35.5
5000	39.5	

Rating according to BS EN ISO 717-1:1997
RW (C;Ctr) = 31 (-2;-4) dB



PATIO DOORSET SPECIFICATION COMPARISON GUIDE

This information provides you with a comparison of the specification across our patio range.

	Canberra - Folding Sliding or French	Darwin - Folding Sliding or French	Oakfold - Folding Sliding or French
Operational detail	Top hung folding sliding or French open out options	Top hung folding sliding or French open out options	Top hung folding sliding or French open out options
Door thickness	54mm	54mm	44mm
Door construction	Solid oak laminate	Solid hardwood laminate	Oak veneer
Frame section size (including head)	FS* 139mm front to back, French 91mm	FS* 139mm front to back, French 91mm	FS* 115mm front to back, French 102mm
Frame material	Oak veneer	Solid hardwood laminate	Oak veneer
Sill material	Aluminium and timber	Aluminium and timber	Aluminium and timber
Sill sizes	190mm - Folding Sliding, 170mm - French 170mm - Side lights	190mm - Folding Sliding, 170mm - French 170mm - Side lights	140mm - Folding Sliding, 160mm - French
Folding sliding min / max actual sizes	Width: 1794mm - 4794mm Height: 1944mm - 2094mm	Width: 1794mm - 4794mm Height: 1944mm - 2094mm	Standard widths only 1794mm - 4794mm Height 2094mm
Single / French min / max (exc side or half side lights)	Widths: 1194, 1494, 1794 Height: 2094mm	Widths: 1194, 1494, 1794 Height: 2094mm	Widths: 1190, 1490, 1790mm Height: 2094mm
Sliding min / max (exc side lights)	Not applicable	Not applicable	Not applicable
Side/half side lights to French/single doorset	Widths: 300, 450 and 600mm. Heights: side lights 2094mm	Widths: 300, 450 and 600mm. Heights: side lights 2094mm	None
Beading	Externally beaded	Externally beaded	Folding sliding - externally beaded French - internally beaded
Standard or made to measure	Folding sliding: made to measure French: standard	Folding sliding: made to measure French: standard	Standard
Locking detail	Multi-point locking, key lockable drop bolts for folding sliding	Multi-point locking, key lockable drop bolts for folding sliding	Multi-point locking, key lockable drop bolts for folding sliding
Handles	Inline polished chrome as standard, choice of six colours	Inline polished chrome as standard, choice of six colours	Brushed chrome
Glazing	28mm toughened double glazing and triple glazing options	28mm toughened double glazing and triple glazing options	20mm toughened double glazing
Spacer bar	Black standard, white and grey optional	Black standard, white and grey optional	Silver
U values (factory glazed)	1.3-1.7 W/m ² K - Folding Sliding 1.3-1.6 W/m ² K - French	1.3-1.7 W/m ² K - Folding Sliding 1.3-1.6 W/m ² K - French	1.8 W/m ² K
Bar designs	Marginal bar available on French. Various bar options available on folding sliding	Marginal bar available on French. Various bar options available on folding sliding	None
Ventilation detail	Trickle ventilation through head of the door top rail. Brown	Trickle ventilation through head of the door top rail. White as standard, grey, green and brown optional	Trickle ventilation through head of the frame. Brown
Brickwork tolerance guidance W & H	12mm overall	12mm overall	12mm overall
Secured by Design	Folding Sliding - optional from Nov 16 French - Yes optional	Folding Sliding - optional from Nov 16 French - Yes optional	Not available
Approved Document Q	Yes optional	Yes optional	Not available
Exposure rating	800	800	No performance declared
Air permeability	Class 3	Class 3	No performance declared
Performance testing	BS6375: Part 1:2009	BS6375: Part 1:2009	No performance declared
Strength/operation testing	No performance declared	No performance declared	No performance declared
Acoustic performance	No performance declared	No performance declared	No performance declared
Responsibility	FSC	FSC	FSC

FS* = Folding Sliding

Wellington - Folding Sliding or French	DreamVu™ - French	Farndale - French	Fenton - Sliding
Top hung folding sliding or French open in or open out options	French open in or open out	French open in or open out	Sliding double or single left hand or right hand doors on smooth nylon runners
44mm	64mm	54mm	54mm
Softwood veneer	Softwood	Softwood	Softwood
FS* 115mm front to back, French 102mm	92mm front to back	91mm front to back	137mm front to back
Softwood white fully finished only	Softwood	Softwood	Softwood
Aluminium and timber	Low level aluminium	Aluminium and timber	Aluminium and timber
140mm - Folding Sliding, 160mm - French, 160mm - Side lights, 160mm - Half side lights	117mm open in, 120mm open out	170mm - French, 170mm - Side lights	166mm - Sliding, 166mm - Side lights
Standard width only between 1794mm to 4194mm, Height 2094mm	Not applicable	Not applicable	Not applicable
Widths: 1190, 1490, 1790mm Height: 2090mm	Standard Widths; Double: 1188, 1488 & 1788mm. Standard Height: 2088mm. Excluding side lights	Standard Widths; Double: 1188, 1488 & 1788mm. Standard Height: 2088mm. Excluding side lights	Not applicable
Not applicable	Not applicable	Not applicable	Widths: 1588, 1788, 2088, 2388. Double: 3576, 4176, 4776 mm Height: 2088mm
Widths: 300, 450 and 600mm. Heights: Side lights 2090, half side lights 1490	Standard Widths: 300, 450 & 600mm Standard Height: 2088mm.	Standard Widths: 300, 450 & 600mm Standard Height: 2088mm Top-lights available	Widths: 968, 1118 & 1268mm Height: 2088mm
None - cassette glazed	Timber-composite pinless external beading on factory paint finished and glazed doorsets	Timber-composite pinless external beading on factory paint finished and glazed doorsets	Externally beaded
Standard	Made to measure	Made to measure	Standard
Multi-point locking, key lockable drop bolts for folding sliding	French – multi-point locking with shoot bolts	French – multi-point locking with shoot bolts	4 point bolt locking system
Brushed chrome	Inline polished chrome as standard, choice of six colours	Inline polished chrome as standard, choice of six colours	Brushed chrome
16mm toughened double glazing	28mm toughened/laminated double glazing as standard or triple glazing optional	28mm toughened double or triple glazing	26mm toughened double glazing with leaded design option available
Silver	Black standard, white and grey optional	Black standard, white and grey optional	Black standard, white and grey optional
1.8 W/m²K	1.1 -1.5 W/m²K	1.1 -1.6 W/m²K	1.4 -1.5 W/m²K
Georgian bar on French available. These do not match the bars on the window range	Yes	Yes	Yes
Trickle ventilation through head of the frame. White	No vents as standard	Trickle ventilation through head of the door top rail. White as standard, brown, grey, green optional	Trickle ventilation through head of the fixed door top rail. White as standard
12mm overall	12mm overall	12mm overall	12mm overall
Not available	Yes standard	Yes optional	Not available
Not available	Yes standard	Yes optional	Not available
No performance declared	800X	800X	No performance declared
No performance declared	No performance declared	Class 3	No performance declared
No performance declared	BS6375: Part 1:2009	BS6375: Part 1:2009	No performance declared
No performance declared	BS6315: Part 2	BS6315: Part 2	No performance declared
No performance declared	Up to 34dB	Up to 31dB	No performance declared
FSC	FSC	FSC	FSC

CHOOSING THE RIGHT PATIO

Patio doorsets are an ideal way to improve the design of a home and add value to it. They allow extra light providing thermal benefits whilst offering functional and aesthetic appeal.

We have a range of standard and made to order sizes to choose from to fit whatever project you are working on.

Our oak Canberra and hardwood Darwin products are engineered and laminated, which means that rather than using a single piece of oak or hardwood, we use separate pieces permanently bonded together, providing a stronger dimensional stability. Oak veneer has decorative slices of oak with a lower density core.

Component construction



SPECIFYING PATIO DOORSETS

There are a number of things to consider when specifying patio doorsets:

- **Design** – The style and finish of the products need to reflect the building design, any planning guidance and the aspirations of the client.
- **Size and space** – The type of patio you can choose will depend on the space and location it is going into and the opening space it will have. You need to consider if you want it to open in, out, concertina (fold and slide) or slide for smaller spaces. Concertina will open out only.
- **Material** – We have oak, hardwood or softwood patio doorsets to choose from with different features and benefits.
- **Design details** – Finishing options, glazing requirements, locks, added security e.g. PAS 24
- **Building Regulations** – The Building Regulations for the replacement of windows and doors vary to new build, and there may be differences between England, Scotland and Wales who each have their own standards. See the Building Regulations section on page 8 for further information.
- **Performance** – such as acoustics, air permeability and exposure rating.
- **Budget** – Consider whole life cycle costing depending on client requirements as timber is expected to last almost twice as long as PVC-U frames.
- **Responsible** – Timber is the only truly sustainable building material and is carbon neutral, fully recyclable and biodegradable. All our patio doorsets are FSC certified which means we have sourced wood from Chain of Custody forests that have been independently verified against worldwide standards.

THERMAL TRANSMITTANCE

The thermal performance of external joinery is an important consideration when specifying products to ensure their performance meets the required standards.

Thermal transmittance, also known as U values is the rate of transfer of heat (in watts) through one square metre of a structure divided by the difference in temperature across the structure. It is expressed in watts per metres squared kelvin, or W/m^2K . Well-insulated parts of a building have a low thermal transmittance whereas poorly insulated parts of a building have a high thermal transmittance.

U values in patio doorsets are calculated in accordance with ISO-10077-2. Thermal performance of windows and doorsets is affected by various elements of the design including timber section size, glass specification and weather seals. JELD-WEN aims to offer a range of different products covering different U values to suit your requirements. Below is a graph which illustrates a comparison with how our ranges compare to provide guidance on range selection.

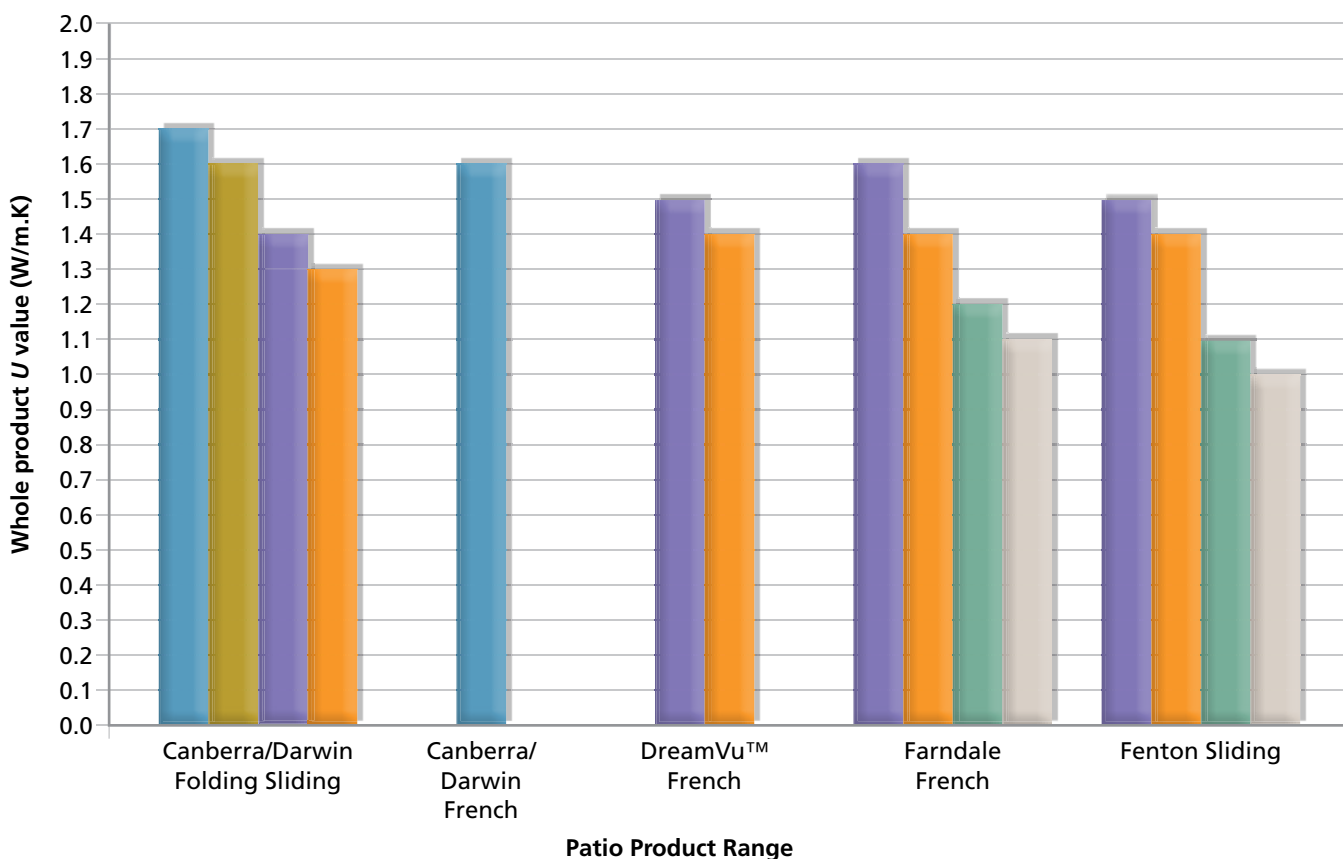

Key to Glazing Specification

- 4-16-4 Standard Low-E
- 4-16-4 Super Low-E
- 4-20-4 Standard Low-E
- 4-20-4 Super Low-E
- 4-8-4-8-4 Standard Low-E
- 4-8-4-8-4 Super Low-E

OAK CANBERRA

SOLID OAK, FOLDING SLIDING PATIO DOORSET

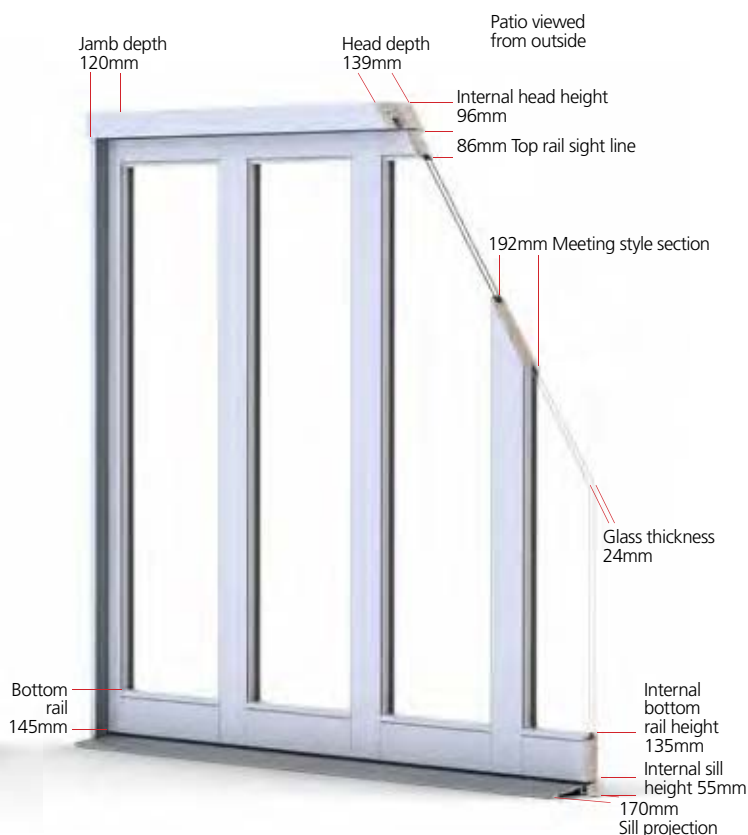

Our Canberra patios are our premium oak range for those that want the best quality timber. They offer the ultimate in style and elegance and their solid structure delivers additional stability and strength.

- U values available 1.3-1.7 W/m²K
- 24mm toughened double glazed with black warm edge spacer bar
- 54mm solid oak engineered door leaves that fold and slide
- Engineered construction oak veneered frame
- Top hung hardware for ease of operation
- Hardex polished chrome handles and locking system from ERA's Vectis Plus range, using a traditional 5 lever mortice lock technology with cylinder-free multi-point locking, other options available, see page 154
- Multi-point locking with shoot bolts. Drop bolts in brushed chrome with polished titanium gold option
- Standard and made to measure sizes available
- Standard size CAD drawings are available to download on our website.
- Choice of golden oak or dark oak Hi-Build stain finish, see page 152
- Configuration choices of 2, 3, 4, 5 and 6 doors
- Factory glazed doorsets are CE Marked
- FSC certified, Chain of Custody on request
- PAS 24 specification options available to meet the requirements of Approved Document Q and Secured by Design
- For full specification details see page 112





Glazing

Using glazing rebates of 18mm x 43mm, Canberra patios will accept 24mm (4:16:4) insulating glass units as standard. The glazing system is fully drained and vented with a sloping bottom platform. A full 5mm clearance is provided between the insulating glass unit and rebate, in compliance with BS 6262.

Ventilation

Flush fitting ventilators are supplied fitted as standard to all Canberra patios to assist in compliance with Approved Document F of the Building Regulations. These provide an Equivalent Area of 8970mm². This product is also available with no trickle ventilation at time of order.

Sill Detail

A standard sill provides a projection of 170mm. Care must be taken to ensure that the sill width is suitable for the specified building in detail whilst achieving compliance with Approved Document L, and to allow for internal sill drainage to clear the brickwork.



U-Value available down to: 1.3 W/m²K



Background ventilation provided, to assist with compliance of Approved Document F





Two door left (2L)



Three door left (3L)



Two door left, one door right (2L1R)



Four door left (4L)



Three door left, one door right (3L1R)



Two door left, two door right (2L2R)



Five door left (5L)



Four door left, one door right (4L1R)



Three door left, two door right (3L2R)



Five door left, one door right (5L1R)



Three door left, three door right (3L3R)



Four door left, two door right (4L2R)

Door Configuration Options (Doors open out only)

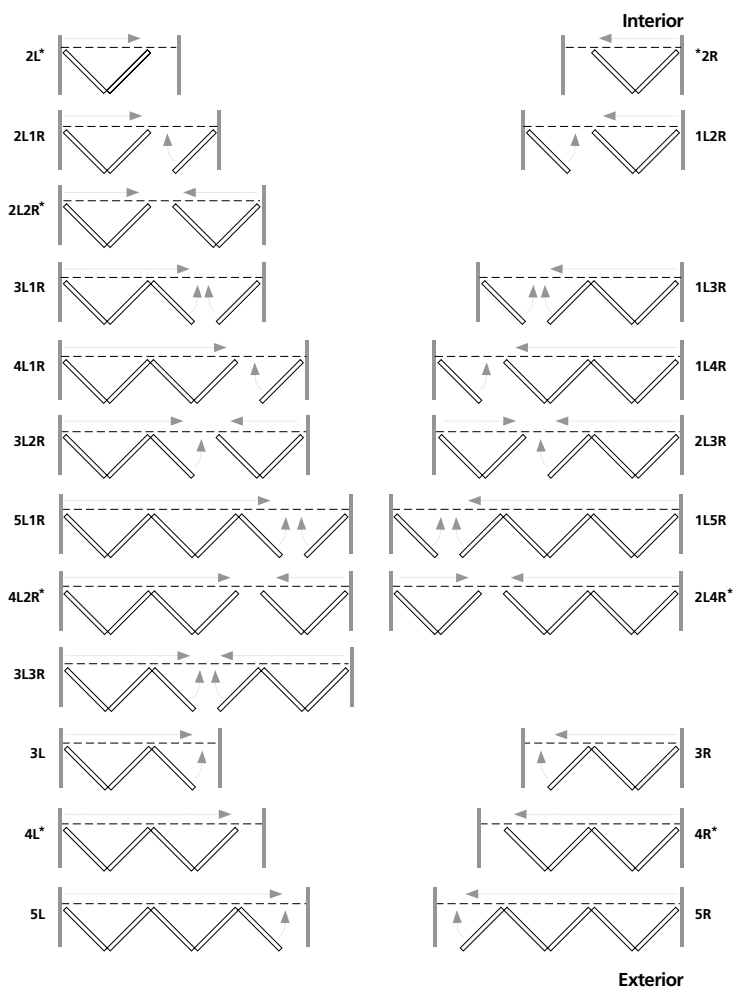

Key

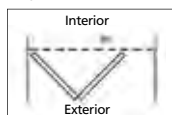

All configurations are available with opposite handing, please specify on your order.

All sliding configurations 3L – 5L or 3R – 5R are specials & pricing is available on request.

* These door configurations can be locked from the inside only and are supplied with thumb-turn locks only.

SPECIAL SIZE LIMITATIONS

Number of doors	Minimum Width	Maximum Width	Minimum Height	Maximum Height
2	1794mm	1794mm	1944mm	2094mm
3	1794mm	2656mm	1944mm	2094mm
4	2368mm	3518mm	1944mm	2094mm
5	2942mm	4194mm	1944mm	2094mm
6	3516mm	4794mm	1944mm	2094mm

SECTION DETAILS

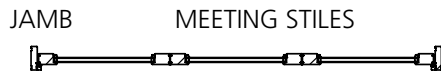

SECTION A-A

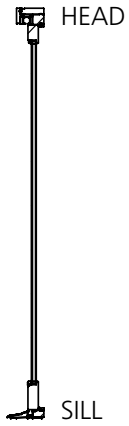
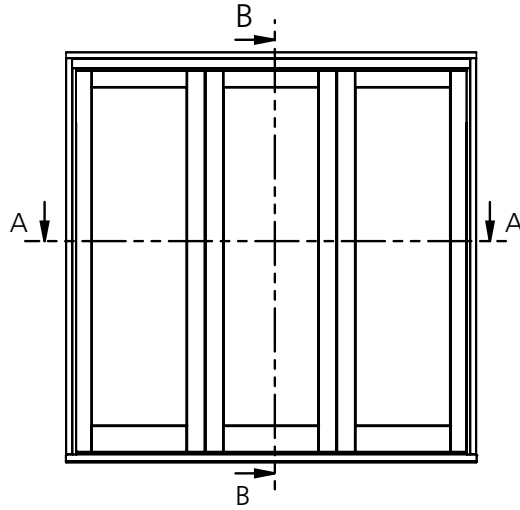

SECTION B-B

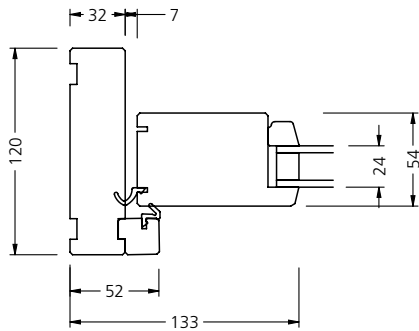

JAMB

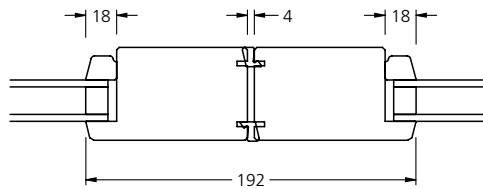

MEETING STILES

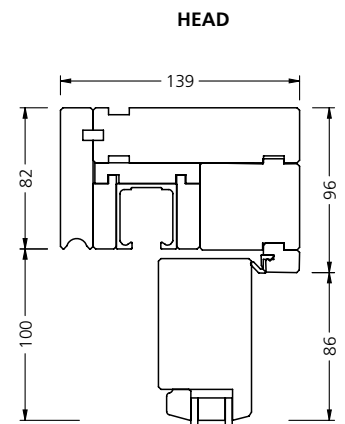

HEAD

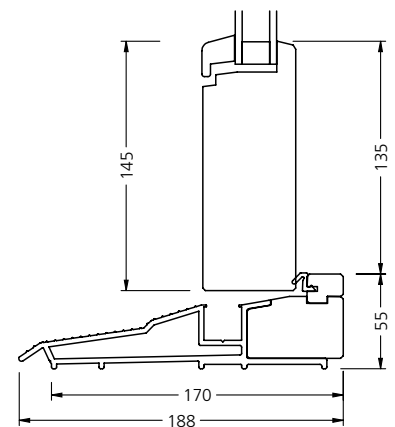

SILL

DARWIN

HARDWOOD, FOLDING SLIDING PATIO DOORSET

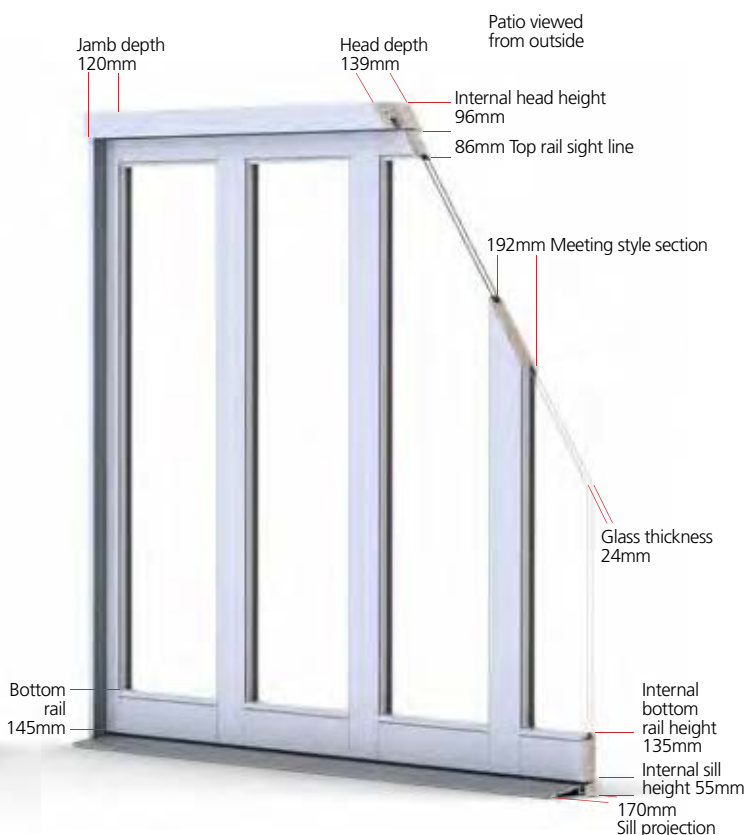

The Darwin hardwood patio door range combines style and strength for the discerning homeowner. Its 54mm thick doors offer a robust doorset which can be painted or stained in a range of popular colours to match other exterior décor.

- U values available 1.3-1.7 W/m²K
- 24mm toughened double glazing double glazed with black warm edge spacer bar
- 54mm solid hardwood laminated door leaves that fold and slide
- Solid hardwood engineered frame
- Top hung hardware for ease of operation
- Hardex polished chrome handles and locking system from ERA's Vectis Plus range, using a traditional 5 lever mortice lock technology with cylinder-free multi-point locking, other options available, see page 154
- Multi-point locking with shoot bolts. Drop bolts in brushed chrome with polished titanium gold option
- Standard and made to measure sizes available
- Standard size CAD drawings are available to download on our website
- Fully finished in white as standard. Golden oak and other paint and stain options available, see page 152
- Configuration choices of 2, 3, 4, 5 and 6 doors
- Factory glazed doorsets are CE Marked
- FSC certified, Chain of Custody on request
- PAS 24 specification options available to meet the requirements of Approved Document Q and Secured by Design
- For full specification details see page 112





Glazing

Using glazing rebates of 18mm x 43mm, Darwin patios will accept 24mm (4:16:4) insulating glass units as standard. The glazing system is fully drained and vented with a sloping bottom platform. A full 5mm clearance is provided between the insulating glass unit and rebate, in compliance with BS 6262.

Ventilation

Flush fitting ventilators are supplied fitted as standard to all Darwin patios to assist in compliance with Approved Document F of the Building Regulations. These provide an Equivalent Area of 8970mm². This product is also available with no trickle ventilation at time of order.

Sill Detail

A standard sill provides a projection of 170mm. Care must be taken to ensure that the sill width is suitable for the specified building in detail whilst achieving compliance with Approved Document L, and to allow for internal sill drainage to clear the brickwork.



U-Value
available
down to:
1.3 W/m²K



Background
ventilation
provided, to assist
with compliance
of Approved
Document Part F



Two door left (2L)



Three door left (3L)



Two door left, one door right (2L1R)



Four door left (4L)



Three door left, one door right (3L1R)



Two door left, two door right (2L2R)



Five door left (5L)



Four door left, one door right (4L1R)



Three door left, two door right (3L2R)



Five door left, one door right (5L1R)



Three door left, three door right (3L3R)



Four door left, two door right (4L2R)

Door Configuration Options (Doors open out only)

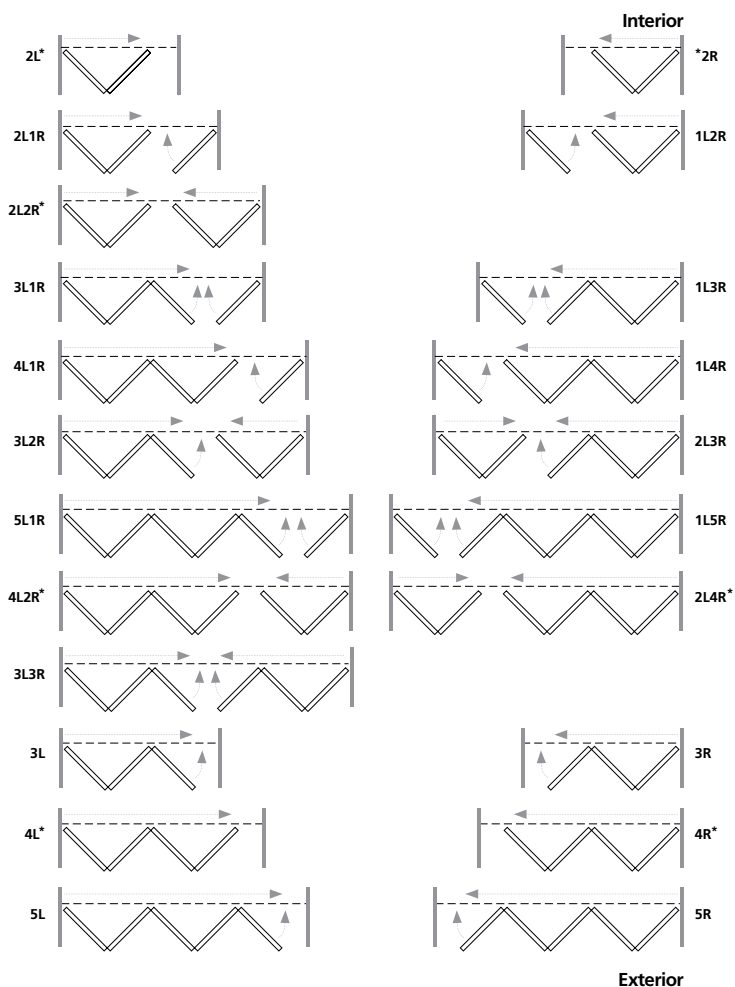

Key

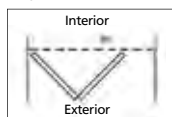

All configurations are available with opposite handing, please specify on your order.

All sliding configurations 3L – 5L or 3R – 5R are specials & pricing is available on request.

* These door configurations can be locked from the inside only and are supplied with thumb-turn locks only.

SPECIAL SIZE LIMITATIONS

Number of doors	Minimum Width	Maximum Width	Minimum Height	Maximum Height
2	1794mm	1794mm	1944mm	2094mm
3	1794mm	2656mm	1944mm	2094mm
4	2368mm	3518mm	1944mm	2094mm
5	2942mm	4194mm	1944mm	2094mm
6	3516mm	4794mm	1944mm	2094mm

SECTION DETAILS

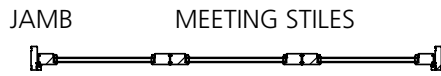

SECTION A-A

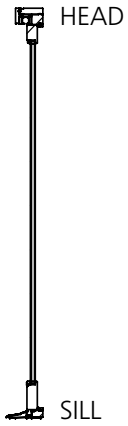
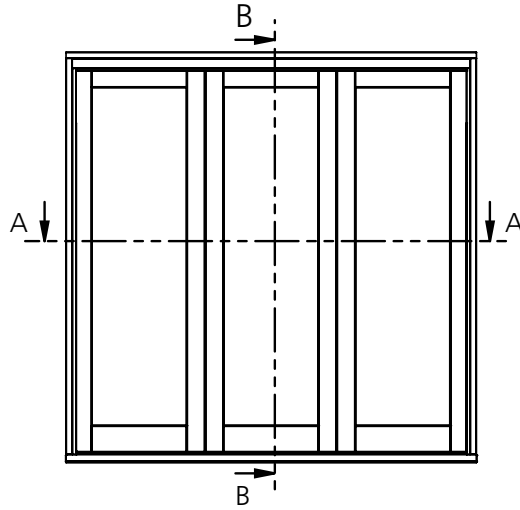

SECTION B-B

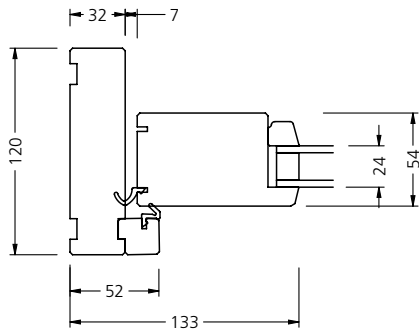

JAMB

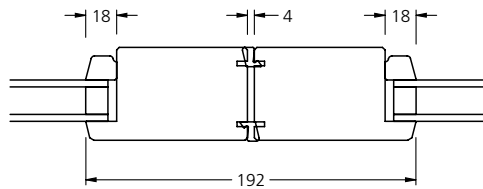

MEETING STILES

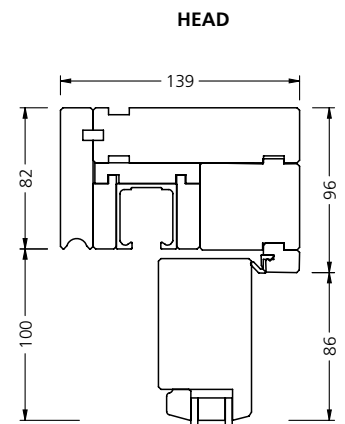

HEAD

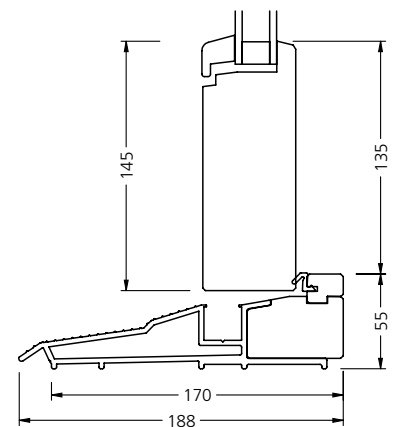

SILL

OAK CANBERRA

SOLID OAK, FRENCH PATIO DOORSET

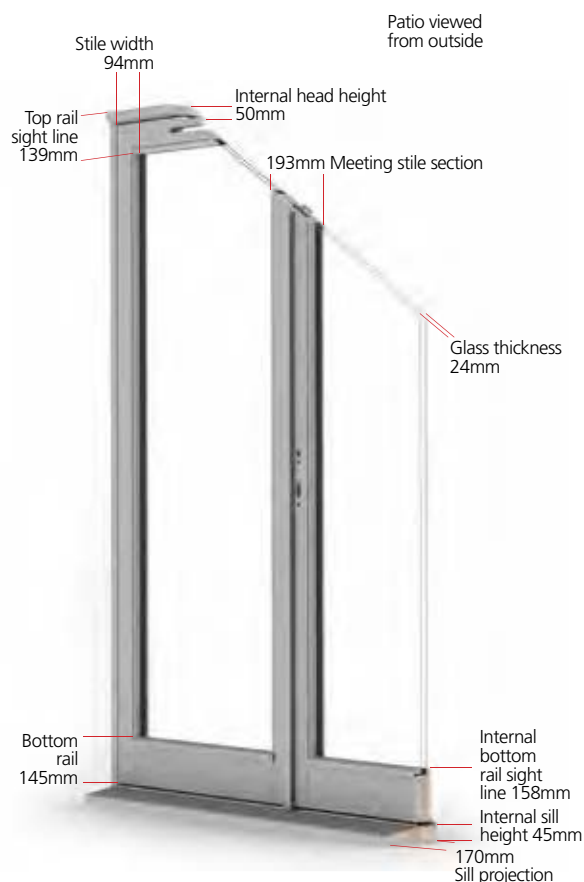

The Canberra French doorset is the classic extension to our premium Canberra folding sliding patio door range. Made from the same solid oak engineered material and hardware, it offers a high quality, suited option to a property.

- U value 1.3-1.6 W/m²K
- 24mm toughened double glazing double glazed with black warm edge spacer bar
- 54mm solid oak laminated door leaves that open out
- Engineered construction oak veneered frame
- Hardex polished chrome handles and locking system from ERA's Vectis Plus range, using a traditional 5 lever mortice lock technology with cylinder-free multi-point locking, other options available, see page 154
- Multi-point locking
- Key/key locking only
- Standard sizes only. CAD drawings are available to download on our website.
- Choice of golden oak or dark oak Hi-Build stain finish, see page 152
- Factory glazed doorsets are CE Marked
- Choice of plain or marginal fret design with wing light options
- FSC certified, Chain of Custody on request
- PAS 24 specification options available to meet the requirements of Approved Document Q and Secured by Design
- For full specification details see page 112





Glazing

Using glazing rebates of 18mm x 43mm, Canberra patios will accept 24mm (4:16:4) insulating glass units as standard. The glazing system is fully drained and vented with a sloping bottom platform. A full 5mm clearance is provided between the insulating glass unit and rebate, in compliance with BS 6262.

Ventilation

Flush fitting ventilators are supplied fitted as standard to all Canberra patios to assist in compliance with Approved Document F of the Building Regulations. These provide an Equivalent Area of 8970mm². This product is also available with no trickle ventilation at time of order.

Sill Detail

A standard sill provides a projection of 170mm. Care must be taken to ensure that the sill width is suitable for the specified building in detail whilst achieving compliance with Approved Document L, and to allow for internal sill drainage to clear the brickwork.



U-Value
available
down to:
1.6 W/m²K



Background
ventilation
provided, to assist
with compliance
of Approved
Document F

SECTION DETAILS

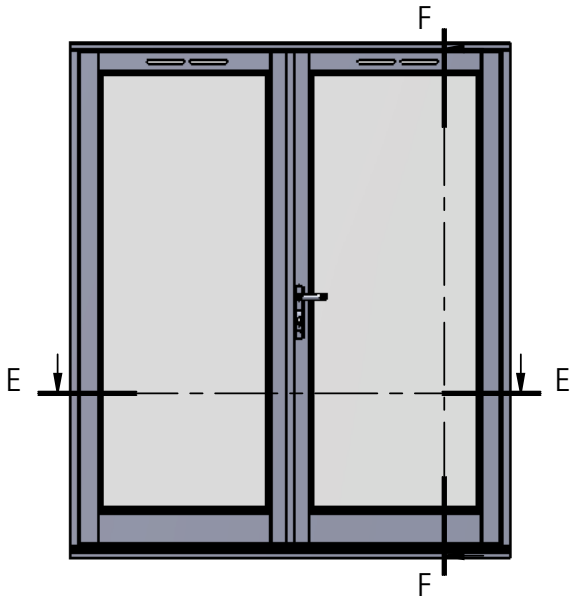

SECTION E-E

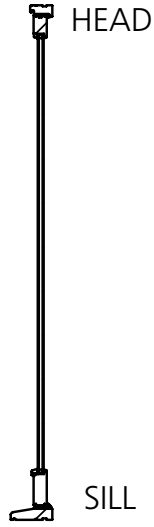

SECTION F-F

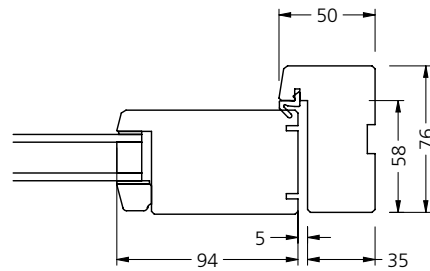
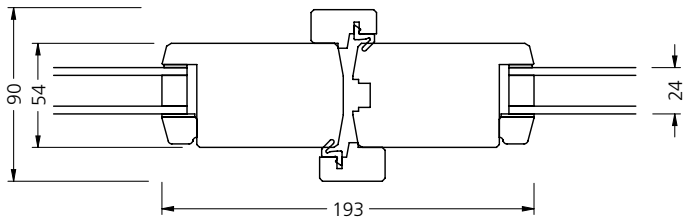
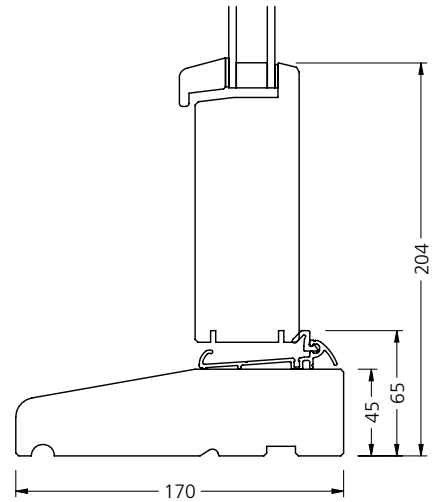
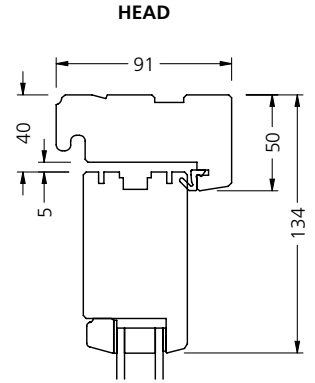



DARWIN

HARDWOOD, FRENCH PATIO DOORSET

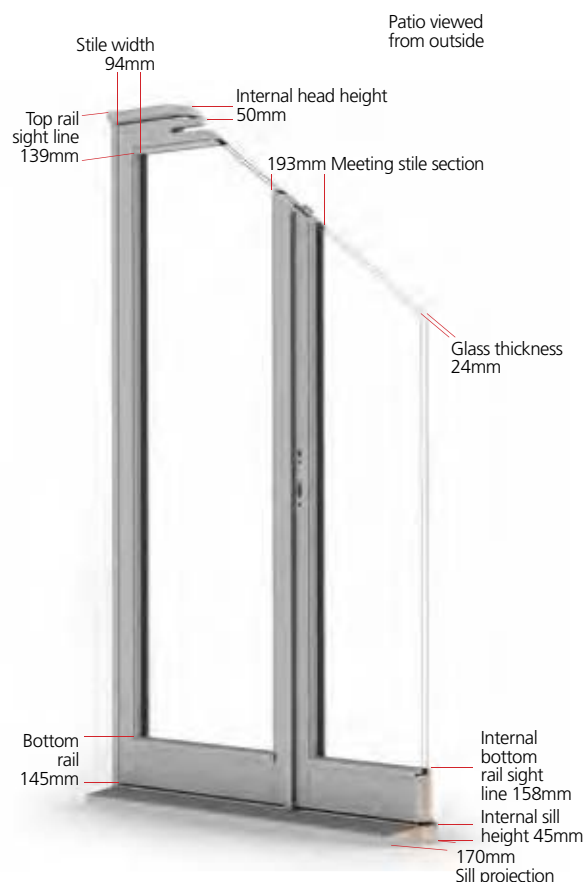

Choose a Darwin hardwood patio doorset if you want a solid product that can be painted or stained to match the JELD-WEN window range. These French doors have optional side lights and complement the new Darwin hardwood folding sliding doorsets.

- U value 1.3-1.6 W/m²K
- 24mm toughened double glazing double glazed with black warm edge spacer bar
- 54mm solid hardwood laminated door leaves that open out
- Solid hardwood engineered frame
- Hardex polished chrome handles and locking system from ERA's Vectis Plus range, using a traditional 5 lever mortice lock technology with cylinder-free multi-point locking, other options available, see page 154
- Key/key locking only
- Standard sizes only. CAD drawings are available to download on our website.
- Fully finished in white as standard. Golden oak and other paint and stain options available, see page 152
- Factory glazed doorsets are CE Marked
- Choice of plain or marginal fret design with wing light options
- FSC certified, Chain of Custody on request
- PAS 24 specification options available to meet the requirements of Approved Document Q and Secured by Design
- For full specification details see page 112





Glazing

Using glazing rebates of 18mm x 43mm, Darwin patios will accept 24mm (4:16:4) insulating glass units as standard. The glazing system is fully drained and vented with a sloping bottom platform. A full 5mm clearance is provided between the insulating glass unit and rebate, in compliance with BS 6262.

Ventilation

Flush fitting ventilators are supplied fitted as standard to all Darwin patios to assist in compliance with Approved Document F of the Building Regulations. These provide an Equivalent Area of 8970mm². This product is also available with no trickle ventilation at time of order.

Sill Detail

A standard sill provides a projection of 170mm. Care must be taken to ensure that the sill width is suitable for the specified building in detail whilst achieving compliance with Approved Document L, and to allow for internal sill drainage to clear the brickwork.



U-Value available down to: 1.6 W/m²K



Background ventilation provided, to assist with compliance of Approved Document Part F



SECTION DETAILS

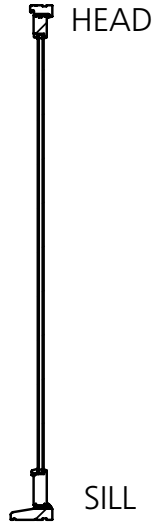
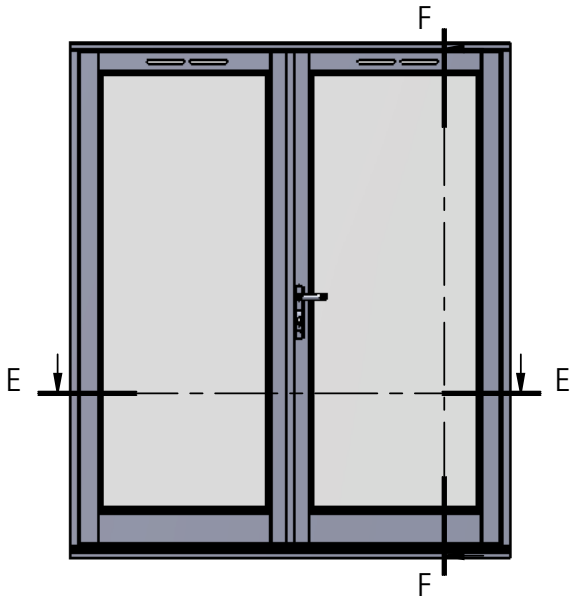

SECTION F-F

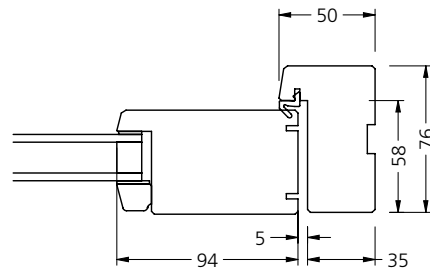
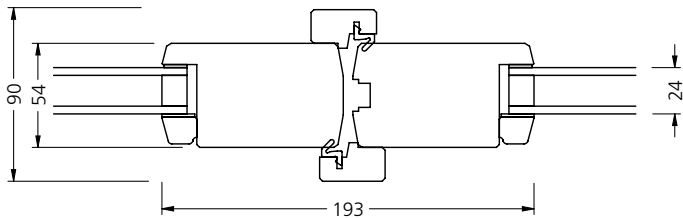
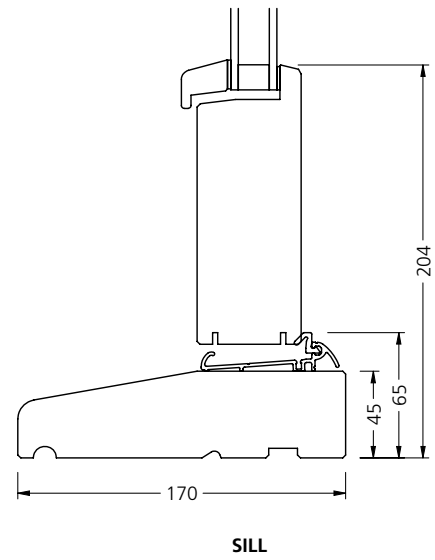
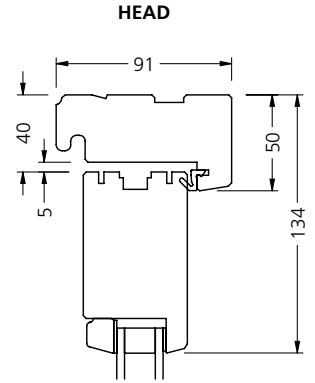



DREAMVU™ HIGH PERFORMANCE

SOFTWOOD, FRENCH DOORSET



This high performance French doorset is available in softwood timber and offers ultimate weather resistance and security.

- U values available 1.1 -1.5 W/m²K
- 28mm double or triple glazed with black warm edge spacer bar and laminated outer pane as standard
- 64mm softwood door leaves that open in or out
- Hardex polished chrome handles and locking system from ERA's Vectis Plus Fortress range, using a traditional 5 lever mortice lock technology with cylinder-free multi-point locking, see page 154 for other options
- Standard and made to measure sizes available
- CAD drawings are available to download on our website
- Glazing bar options available
- Fully finished in Hi-Build white paint as standard. Other colour options available, see page 152
- Factory glazed doorsets are CE Marked
- FSC certified, Chain of Custody on request
- PAS 24 specification options available to meet the requirements of Approved Document Q and Secured by Design
- For full specification details see page 112





Glazing

Using glazing rebates of 18mm x 53mm, our High Performance DreamVu™ patios will accept either double or triple glazed units. The glazing system is fully drained and vented with a sloping bottom platform. A full 5mm clearance is provided between the insulating glass unit and rebate, in compliance with BS 6262.

Ventilation

The DreamVu™ doorset is supplied as standard without any trickle ventilation installed. This is due to the nature of the developments it is more commonly specified in, such as buildings incorporating heat recovery systems.

Sill Detail

A standard aluminium sill provides a projection of 102mm for open in and 104mm for open out. Care must be taken to ensure that the sill width is suitable for the specified building in detail whilst achieving compliance with Approved Document L, and to allow for internal sill drainage to clear the brickwork. An internal ramp is available if required to achieve compliance with Approved Document M.



Assistance with compliance of Approved Document M available on certain widths.



dB reductions up to: 34dB



U-Value available down to: 1.0 W/m²K

FRENCH DOORSET SECTION DETAILS

OPEN OUT

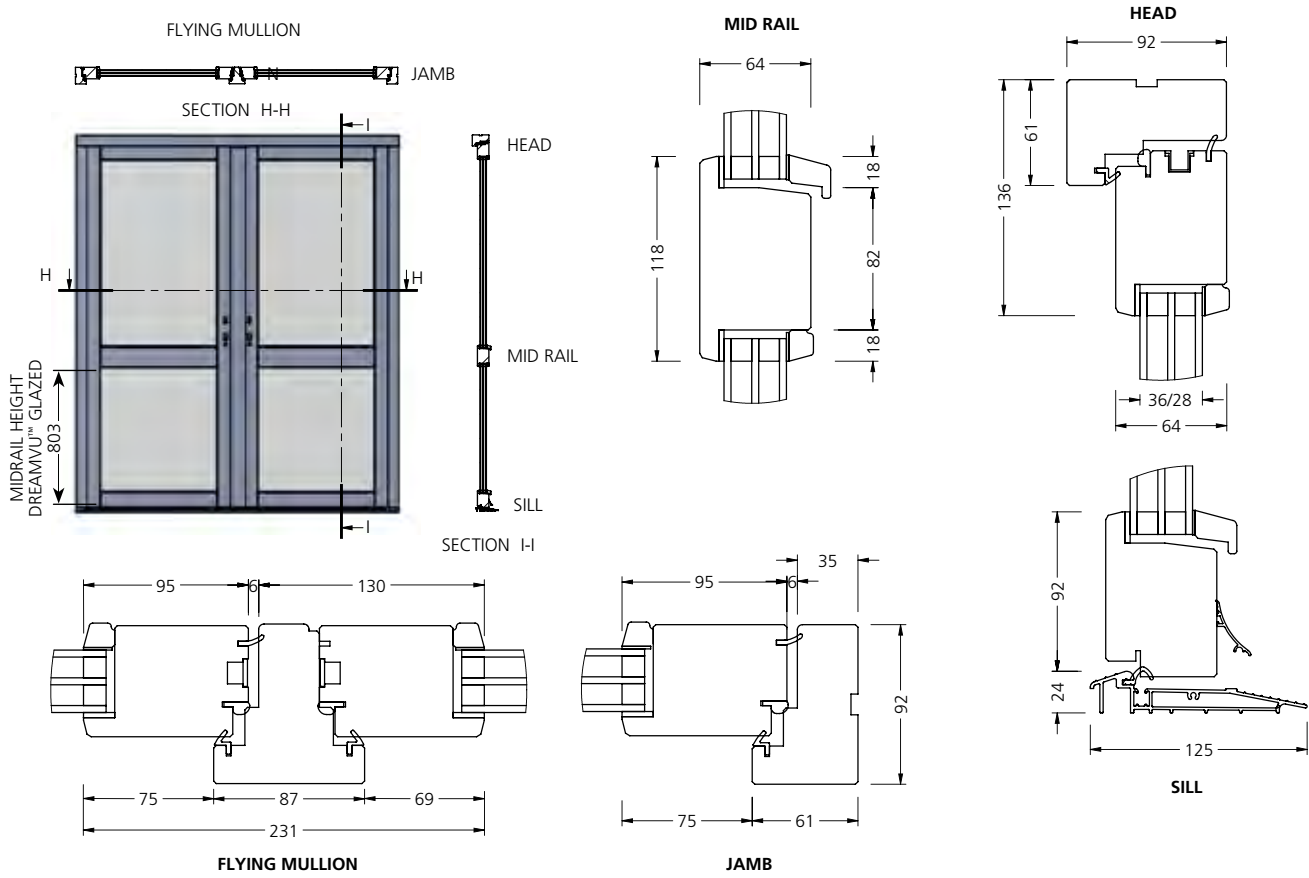

OPEN IN

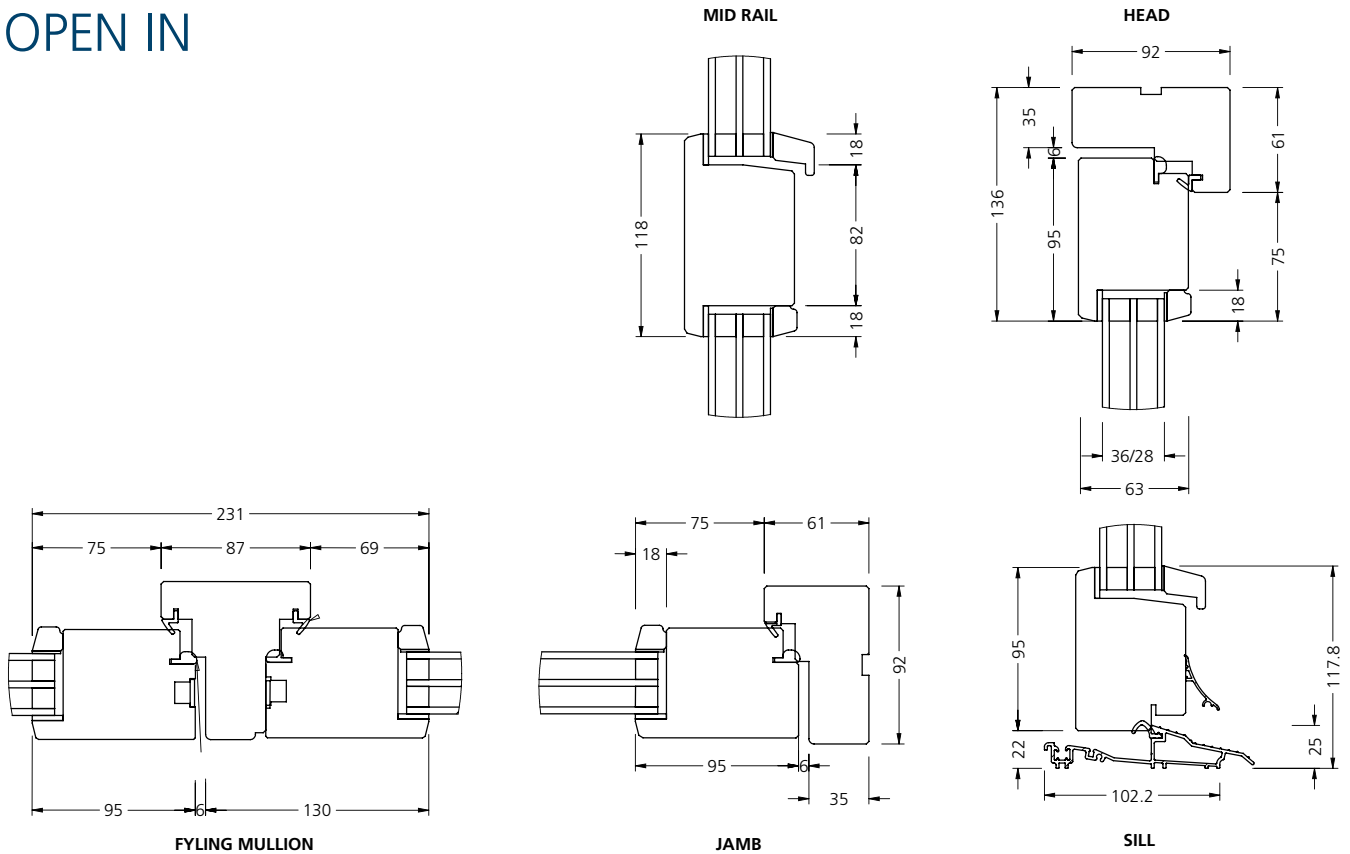

SIZE LIMITATIONS

Our DreamVu™ Doorset range is available as standard sizes or made to measure. When specifying made to measure products, the below limitations should be used as a guide to what can be manufactured.

Range	Min Frame Width (mm)	Min Frame Height (mm)	Max Frame Width (mm)	Max Frame Height (mm)
Double doorset	1138	1788	1888	2238*
Side light	300	1788	600	2238*

* PAS 24 available on door heights up to 2100mm

Please note, configuration limitations vary within the min/max dimensions due to weight and sash proportions. For further detailed sizing please contact our estimating department on 0845 1222892.

ACOUSTIC PERFORMANCE

External noise reduction is required from various different sources. These can either be road traffic, air traffic, rail or pedestrians. Depending on the different sources, certain frequencies will be relatively higher which results in a significant reduction required for this specific band of frequency. These tables detail these bands, which will enable you to see the exact performance of the product.

DreamVu™ Doorset Standard glass
4-12-4-12-4

Freq F HZ	Sound Reduction Index, dB	
	1/3 Octave	1/1 Octave
100	22.6	20.3
125	19.5	
160	18.7	
200	24.1	22.1
250	20.8	
315	21.5	
400	25.3	30.1
500	31.7	
630	33.2	
800	35.7	35.9
1000	35.5	
1250	36.6	
1600	38.3	37.1
2000	37.9	
2500	35.2	
3150	31.2	33.7
4000	33.7	
5000	36.3	

Rating according to BS EN ISO 717-1:1997
RW (C;Ctr) = 33 (-2;-5) dB

DreamVu™ Doorset Acoustic glass
6-16-6.4 Acoustic Glass

Freq F HZ	Sound Reduction Index, dB	
	1/3 Octave	1/1 Octave
100	22.8	19.9
125	21.1	
160	15.7	
200	23.8	25.4
250	26.1	
315	26.3	
400	31.4	33.5
500	33.8	
630	35.2	
800	36.5	36.0
1000	36.1	
1250	35.4	
1600	35.9	34.9
2000	34.0	
2500	34.7	
3150	38.4	39.0
4000	39.5	
5000	39.2	

Rating according to BS EN ISO 717-1:1997
RW (C;Ctr) = 34 (-1;-4) dB

FARNDALE

SOFTWOOD, FRENCH DOORSET



Diagrams are based on a PATT ZXGG doorset.



The Farndale French doorset feature an attractive, contemporary design, with slim timber sections to maximise the glazed area. Available made to measure in a variety of designs.

- U values available 1.1-1.6 W/m²K
- 28mm double or triple glazing with black warm edge spacer bar
- 54mm softwood door leaves that open in or out
- Hardex polished chrome handles and locking system from ERA's Vectis Plus Fortress range, using a traditional 5 lever mortice lock technology with cylinder-free multi-point locking, see page 154 for other options
- Standard and made to measure sizes, top and side light options
- CAD drawings are available to download on our website
- Various designs to choose from. Bottom panel designs will be supplied with flat panels
- Right hand opens first as viewed from the outside
- Base coat stained as standard. Factory finished option Hi-Build white as standard. Other colour options available, see page 152
- Factory glazed doorsets are CE Marked
- FSC certified, Chain of Custody on request
- Special widths are available to order. 300mm side lights will be supplied with horizontal bars only as standard. If you require any other design, please specify at time of ordering
- Pinless beading on factory paint finished and glazed doorsets
- For full specification details see page 112





PATT 2XG

Glazing

Using glazing rebates of 18mm x 43mm, our Farndale patios will accept 28mm (4:20:4) insulating glass units as standard. The glazing system is fully drained and vented with a sloping bottom platform. A full 5mm clearance is provided between the insulating glass unit and rebate, in compliance with BS 6262.

Ventilation

Flush fitting ventilators are supplied fitted as standard to all Farndale doorsets to assist in compliance with Approved Document F of the Building Regulations. These provide an Equivalent Area of 8970mm² for double doorsets and 4485mm² for single doorsets. This product is also available with no trickle ventilation at time of order.

Sill Detail

A standard timber sill provides a projection of 170mm, with an aluminium threshold fixed to the sill to assist with drainage and compliance with Approved Document M. Care must be taken to ensure that the sill width is suitable for the specified building in detail whilst achieving compliance with Approved Document L, and to allow for internal sill drainage to clear the brickwork.



Assistance with compliance of Approved Document M available on certain widths.



dB reductions up to: 31dB



U-Value available down to: 1.1 W/m²K



Background ventilation provided, to assist with compliance of Approved Document F

FRENCH DOORSET SECTION DETAILS

OPEN IN

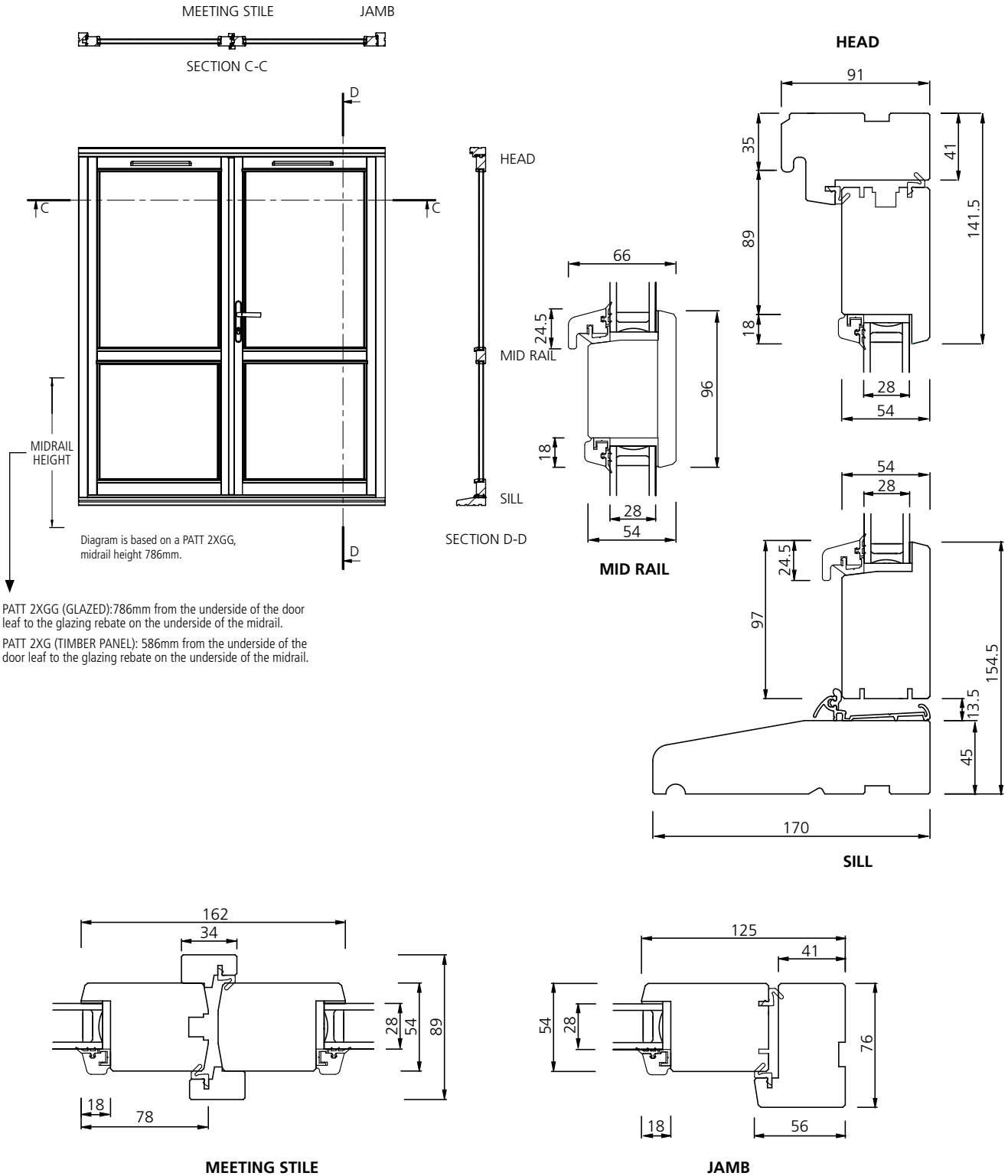

OPEN OUT

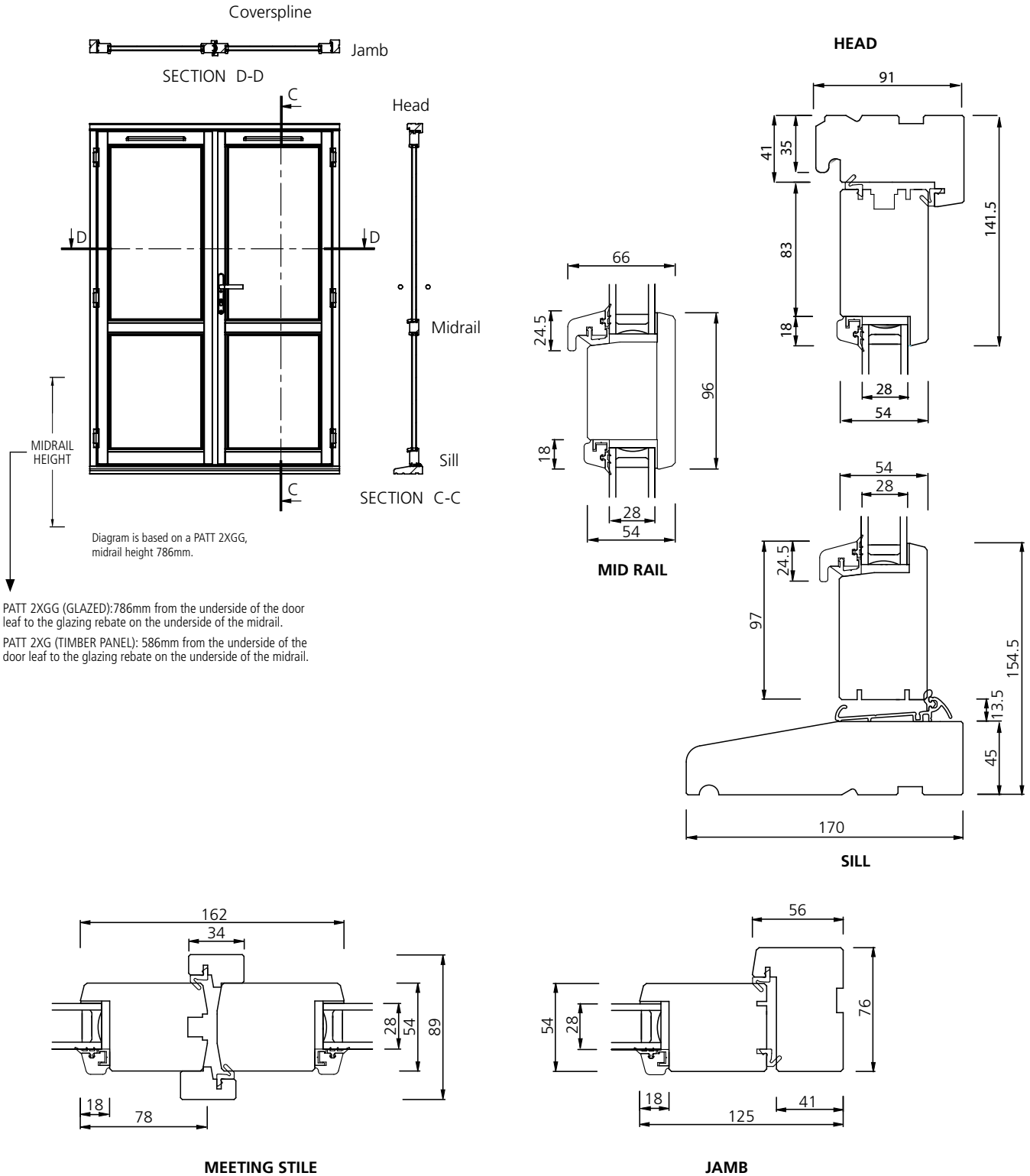

PATT 2XGG (GLAZED): 786mm from the underside of the door leaf to the glazing rebate on the underside of the midrail.

PATT 2XG (TIMBER PANEL): 586mm from the underside of the door leaf to the glazing rebate on the underside of the midrail.

SIZE LIMITATIONS

Our Farndale doorset range is available as standard sizes or made to measure. When specifying made to measure products, the below limitations should be used as a guide to what can be manufactured.

Range	Min Frame Width (mm)	Min Frame Height (mm)	Max Frame Width (mm)	Max Frame Height (mm)
Double doorset	1188*	1792**	1188	2283
Side light	300	1788	600	2238*

* Any leaf below 500mm has no restrictors or trickle vents

** PAS 24 not available on frame heights less than 1800mm and/or greater than 2088mm

Please note, configuration limitations vary within the min/max dimensions due to weight and sash proportions.

For further detailed sizing please contact our estimating department on 0845 1222892.

ACOUSTIC PERFORMANCE

External noise reduction is required from various different sources. These can either be road traffic, air traffic, rail or pedestrians. Depending on the different sources, certain frequencies will be relatively higher which results in a significant reduction required for this specific band of frequency. These tables detail these bands, which will enable you to see the exact performance of the product.

Farndale Standard glass

4-20-4

Freq F HZ	Sound Reduction Index, dB	
	1/3 Octave	1/1 Octave
100	20.6	20.5
125	21.1	
160	19.9	
200	20.7	19.6
250	16.2	
315	22.0	
400	24.1	27.4
500	28.2	
630	29.9	
800	31.8	31.4
1000	31.3	
1250	31.0	
1600	33.1	34.9
2000	36.5	
2500	35.1	
3150	30.1	32.5
4000	32.3	
5000	35.2	

Rating according to BS EN ISO 717-1:1997
RW (C;Ctr) = 30 (-1;-4) dB

Farndale Acoustic glass

6-16-6.4

Freq F HZ	Sound Reduction Index, dB	
	1/3 Octave	1/1 Octave
100	20.9	20.7
125	20.9	
160	20.3	
200	20.8	19.7
250	16.4	
315	21.8	
400	24.4	27.7
500	28.7	
630	30.1	
800	32.3	32.6
1000	32.5	
1250	32.9	
1600	35.7	37.0
2000	38.9	
2500	36.4	
3150	31.3	35.5
4000	35.7	
5000	39.5	

Rating according to BS EN ISO 717-1:1997
RW (C;Ctr) = 31 (-2;-4) dB



FENTON

SOFTWOOD, SLIDING DOORSET



This attractive slimline softwood timber sliding patio doorset comes in a variety of sizes to help you open up tight or large spaces. You can specify a range of Hi-Build paint or stain finishes to give it a contemporary look.

- U values available 1.4-1.5 W/m²K
- 26mm double glazing with black warm edge spacer bar as standard
- 54mm softwood door leaves that slide either left hand, right hand or double openings as specified. When ordering specify right or left hand to slide when viewed from the outside
- Choose a double slider for maximum width supplied with a continuous head and sill (excluding side light options)
- 4 point locking with brushed chrome handles
- Standard sizes only
- CAD drawings are available to download on our website
- Base coat stained as standard. Primed, fully finished in Hi-Build paint or stain optional, see page 152
- Various designs including clear glazed, diamond and rectangular leaded glazing (may differ from the ones shown in the finishing section), Georgian or marginal bar using SDL fret compatible with our window ranges
- Factory glazed doorsets are CE Marked
- FSC certified, Chain of Custody on request
- For full specification details see 112





Glazing

Using glazing rebates of 18mm x 43mm, our Fenton patios will accept 26mm (4:18:4) insulating glass units as standard. The glazing system is fully drained and vented with a sloping bottom platform. A full 5mm clearance is provided between the insulating glass unit and rebate, in compliance with BS 6262.

Ventilation

Trickle ventilators are supplied fitted as standard to all Fenton patios to assist in compliance with Approved Document F of the Building Regulations. These provide an Equivalent Area of 5000mm² for widths of 1600mm and 1800mm and 7700mm² for widths of 2100mm and 2400mm. This product is also available with no trickle ventilation at time of order.

Sill Detail

A standard timber and aluminium sill provides a projection of 155mm. Care must be taken to ensure that the sill width is suitable for the specified building in detail whilst achieving compliance with Approved Document L, and to allow for internal sill drainage to clear the brickwork.



U-Value
available
down to:
1.1 W/m²K



Background
ventilation
provided, to assist
with compliance
of Approved
Document F



SECTION DETAILS

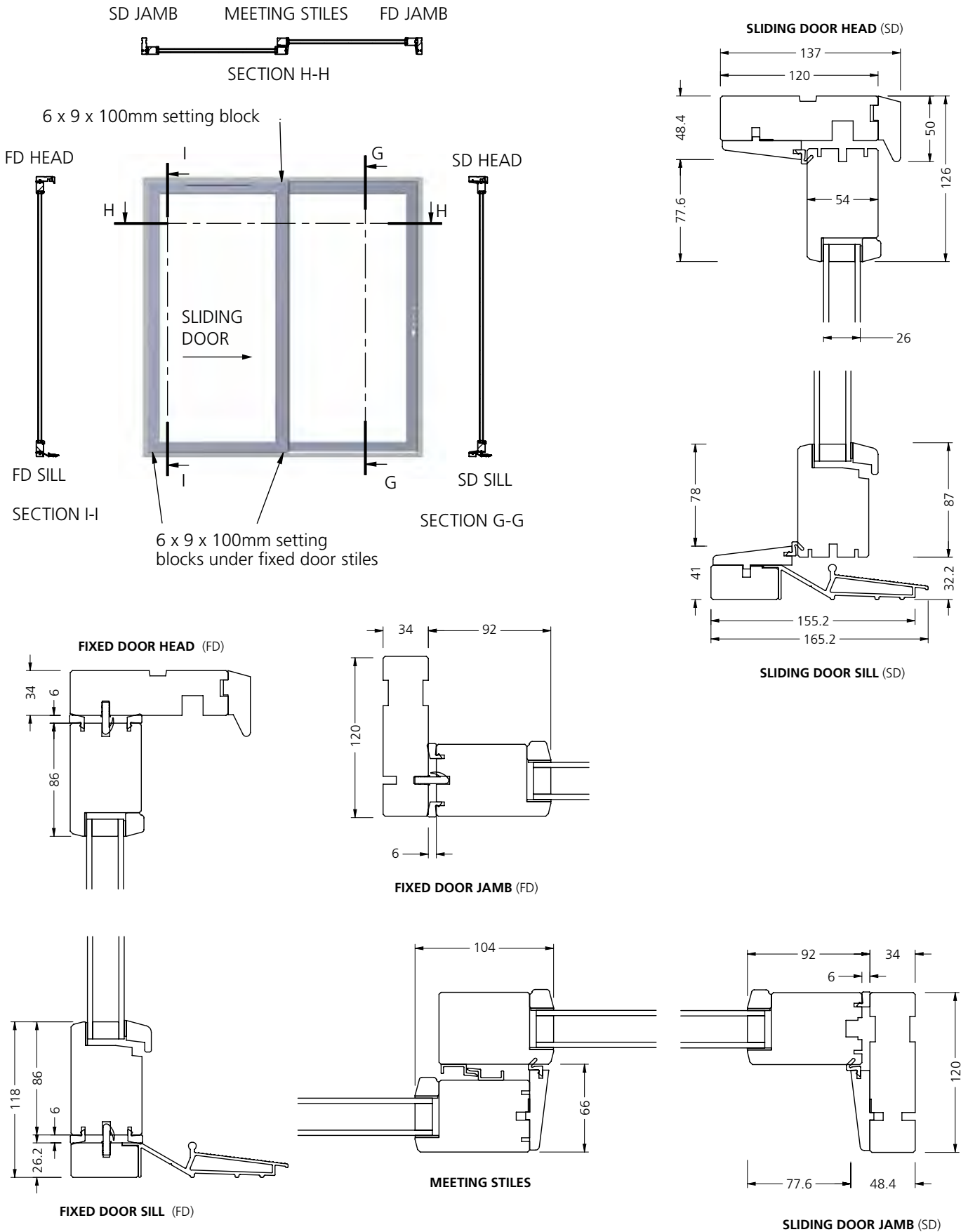



CHOOSING EXTERIOR DOOR FRAMES

All exterior door frames are designed for long-lasting performance and easy installation.

- Assembled oak veneer door frames are available to complement oak Stormsure window ranges and oak external doors. These are made to order. Flat pack oak veneer door frames are available from stock, see page 151.
- Manufactured from quality redwood and oak with hardwood sills as standard where applicable
- Rebated to suit 44mm doors
- 170mm standard sill
- 140mm optional sill
- Fitted heavy duty PVC water bar (not on mobility frames)
- Supplied with a harmonising basecoat stain ready for on-site finishing
- Fully finished door frames available to special order.
- Factory-glazed front entrance frames available to special order including PATT 70, PATTSC, Vertical Bar, see page 149.
- Factory-glazed fixed top lights available on storey height frames available to special order.
- Not all JELD-WEN door designs are compatible with the door frame range, please check before ordering.

For more information on Building Regulations Approved Document L, please refer to page 8.

Door frame and threshold

Building Regulations Approved Document M Mobility Amendment requires disabled access into buildings to be over a threshold no higher than 15mm (as illustrated on page 148).

Mobility

Mobility door frames are supplied with a threshold pack. This pack is loose and requires on-site fixing. Head packers are available to order if required.

Range guide

Assembled	Softwood	Hardwood	Oak
Sill	✓		✓
No Sill	✓	✓	
Mobility	✓		✓
FD30	✓		
FD60		✓	

Unassembled	Softwood
Sill	✓
No Sill	✓
Mobility	✓
GARAGE	✓

Hardwood finishes



Basecoat stain for site finishing (Standard)



Baltic Hi-Build stain, factory finished

Softwood finishes



Basecoat stain for site finishing (Standard)



Primed (grey) for site finishing



Hi-Build white, factory finished

Oak finishes



Basecoat stain for site finishing (assembled oak frames only - Standard)



Unfinished for site finishing (flatpack only - Standard)



Dark Oak Hi-Build stain, factory finished



Golden Oak Hi-Build stain, factory finished

Optional finishes

For extra durability we strongly recommend that you purchase primed door frames for external use. Primed frames are guaranteed for 3 months, base coat stained frames are guaranteed for 1 month before site decoration is required. Please state "primed" or "stained" when ordering. See page 152 for other finishing options.

Finishing options shown are for guidance purposes only. There may be some variation to the finished product supplied.



ASSEMBLED DOOR FRAMES

WEATHERSTRIPPED - WITH SILL

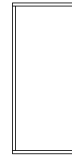

Door Sizes W x H (mm)	Frame Width	Frame Height 2076mm		Frame Height 2127mm	
		Inward Opening	Outward Opening	Inward Opening	Outward Opening
		Code	Code	Code	Code
Softwood					
914 x 1981 (3'0" x 6'6")	1006mm	FN30M	FX30M		
838 x 1981 (2'9" x 6'6")	930mm	FN29M	FX29M		
813 x 2032 (2'8" x 6'8")	905mm			FN28M	FX28M
762 x 1981 (2'6" x 6'6")	854mm	FN26M	FX26M		
686 x 1981 (2'3" X 6'6")	778mm	FN23M	FX23M		
Hardwood					
914 x 1981 (3'0" x 6'6")	1006mm	FN30MH	FX30MH		
838 x 1981 (2'9" x 6'6")	930mm	FN29MH	FX29MH		
762 x 1981 (2'6" x 6'6")	854mm	FN26MH	FX26MH		
Oak					
914 x 1981 (3'0" x 6'6")	1006mm	OFN30M	OFX30M		
838 x 1981 (2'9" x 6'6")	930mm	OFN29M	OFX29M		
813 x 2032 (2'8" x 6'8")	905mm			OFN28M	OFX28M
762 x 1981 (2'6" x 6'6")	854mm	OFN26M	OFX26M		

WEATHERSTRIPPED - NO SILL



Door Sizes W x H (mm)	Frame Width	Frame Height 2031mm*	Frame Height 2082mm*
		Inward and Outward Opening	Inward and Outward Opening
		Code	Code
Softwood			
914 x 1981 (3'0" x 6'6")	1006mm	F30	
838 x 1981 (2'9" x 6'6")	930mm	F29	
813 x 2032 (2'8" x 6'8")	905mm		F28
762 x 1981 (2'6" x 6'6")	854mm	F26	
686 x 1981 (2'3" x 6'6")	778mm	F23	
Hardwood			
914 x 1981 (3'0" x 6'6")	1006mm	F30H	
838 x 1981 (2'9" x 6'6")	930mm	F29H	
762 x 1981 (2'6" x 6'6")	854mm	F26H	



(Image shown with sill option)

WEATHERSTRIPPED - MOBILITY

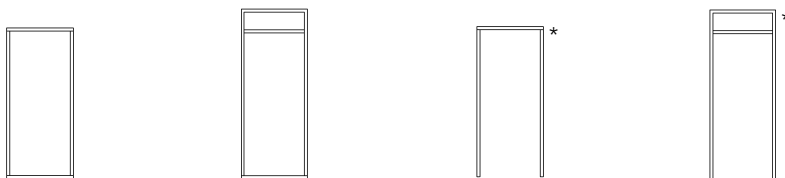

Door Sizes W x H (mm)	Frame Width	Frame Height 2086mm	Frame Height 2395mm	Frame Height 2041mm	Frame Height 2395mm
		Inward Opening	Inward Opening Plus Glazing Options	Inward and Outward Opening	Inward and Outward Opening Plus Glazing Options
		Code	Code	Code	Code
Softwood					
914 x 1981 (3'0" x 6'6")	1006mm	FN30M-MOB	VFN30M-MOB	F30M	VF30M
838 x 1981 (2'9" x 6'6")	930mm	FN29M-MOB	VFN29M-MOB	F29M	VF29M
Hardwood					
914 x 1981 (3'0" x 6'6")	1006mm	FN30MH-MOB	VFN30MH-MOB	F30MH	VF30MH
838 x 1981 (2'9" x 6'6")	930mm	FN29MH-MOB	VFN29MH-MOB	F29MH	VF29MH
Oak					
914 x 1981 (3'0" x 6'6")	1006mm	OFN30M-MOB			
838 x 1981 (2'9" x 6'6")	930mm	OFN29M-MOB			

*Extended jambs to allow mobility threshold up to 14mm high.

WEATHERSTRIPPED - FRENCH CASEMENT (PAIRS)

To suit pairs of doors with 12mm rebated meeting stiles

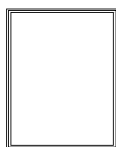

Door Sizes W x H (mm)	Frame Width	Frame Height 2076mm	
		Inward Opening	Outward Opening
		Code	Code
Softwood			
2no. 762 x 1981 (2'6" x 6'6")	1604mm	FN40115M	FX40115M
2no. 838 x 1981 (2'9" x 6'6")	1756mm	FN5055M	FX5055M
1 pair 1168 x 1981 (3'10" x 6'6")	1260mm	FN310M	FCP126310

Vertical section of door frame
(Diagram shown not to scale).

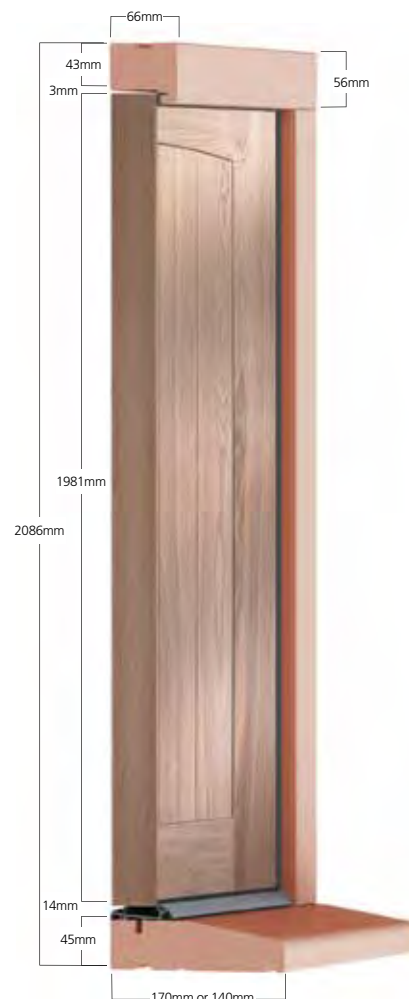

ASSEMBLED DOOR FRAMES

FRONT ENTRANCE DOORS

When ordering, please state "as catalogue" or "opposite catalogue",
"as catalogue" means the sidelight is on the left when viewed from the outside.

WEATHERSTRIPPED - DOORS OPEN INWARDS (UNGLAZED AS STANDARD)

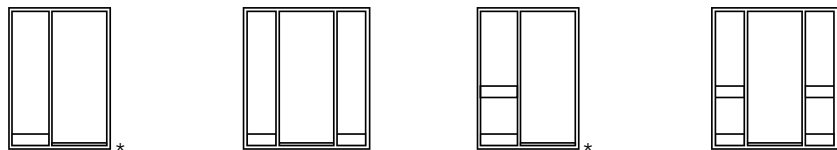

Door Sizes W x H (mm)	Frame Width	Frame Height 2086mm	Frame Height 2086mm	Frame Height 2086mm	Frame Height 2086mm
		Code	Code	Code	Code
Softwood					
838 x 1981 (2'9" x 6'6")	1195mm	FE120029		FER120029	
838 x 1981 (2'9" x 6'6")	1345mm	FE135029		FER135029	
838 x 1981 (2'9" x 6'6")	1495mm	FE150029		FER150029	FERD150029
838 x 1981 (2'9" x 6'6")	1645mm	FE165029	FED165029	FER165029	FERD165029
838 x 1981 (2'9" x 6'6")	1795mm	FE180029	FED180029	FER180029	FERD180029
838 x 1981 (2'9" x 6'6")	2095mm		FED210029		FERD210029

*Side lights are available left hand (shown above) or right hand when viewed from the outside. Please specify handing at time of order.
If not specified side lights will be supplied lefthand.

Factory glazing

We can supply front entrance frames factory-glazed with a variety of different glass types.

Factory glazed options

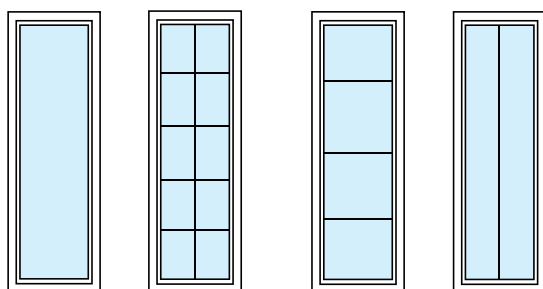

PATT 10

PATT SC

PATT 70

Vertical Bar

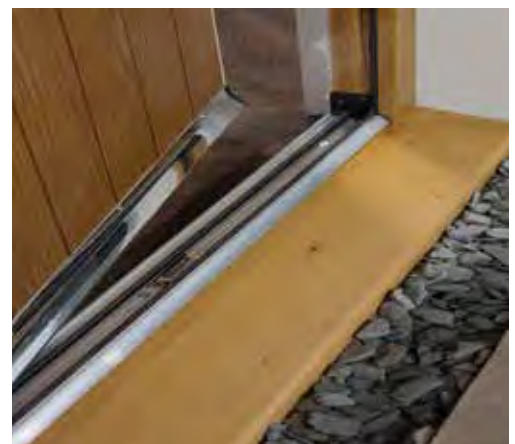

Mobility

We supply entrance frames (838mm door size) fitted with 170mm mobility sills. With these frames, we supply a low-level threshold loose for on-site fitting.



ASSEMBLED DOOR FRAMES

FIRE DOORS

We offer a choice of softwood 30-minute and hardwood 60-minute fire resisting door frames suitable for internal and external use. Both are fitted with 15mm x 4mm intumescent strips as standard. All rebates are 12mm deep, and the frames are tested in compliance with BS 476 Part 22.

30-minute fire resisting door frame fitted with intumescent strip. Our FD30 door frame suits a 44mm (1¾") thick door. Frames available from stock are fitted with one set of 15mm x 4mm intumescent strip. Frames fitted with one set of 15mm x 4mm intumescent strip with a smoke seal are available to order or a 25mm intumescent strip and smoke seal.

30 MINUTE FD30 FIRE RESISTING DOOR FRAMES – WITH INTUMESCENT STRIP

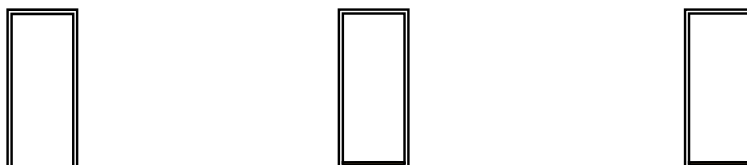

Door Sizes W x H (mm)	Frame Width	Frame Height 2030mm No sill - open in or out		Frame Height 2074mm Standard sill 140mm - open in		Frame Height 2059mm Flush sill 78mm - open in or out	
		Intumescent strip only	Intumescent strip / smoke seal	Intumescent strip only	Intumescent strip / smoke seal	Intumescent strip only	Intumescent strip / smoke seal
Softwood							
762 x 1981 (2'6" x 6'6")	851mm	DF26FCA2	SDF26FCA2	DF26FCA1	SDF26FCA1	DF26FCA3	SDF26FCA3
813 x 2032 (2'8" x 6'8")	901mm	DF28FCA2	SDF28FCA2				
838 x 1981 (2'9" x 6'6")	927mm	DF29FCA2	SDF29FCA2	DF29FCA1	SDF29FCA1	DF29FCA3	SDF29FCA3
Frame Height 2089mm							
Metric 726 x 2040	815mm	DF726FCA2	SDF726FCA2				
Metric 826 x 2040	915mm	DF826FCA2	SDF826FCA2				
Metric 926 x 2040	1015mm	DF926FCA2	SDF926FCA2				



60-minute fire resisting door frame fitted with smoke and intumescent seal/strips. This FD60 door frame suits a 54mm (2⅛") thick door. Fitted with one set of 15mm x 4mm intumescent strip with a smoke seal and one set of 15mm x 4mm intumescent strip.

60 MINUTE FD60 FIRE RESISTING DOOR FRAMES – WITH INTUMESCENT STRIP



Door Sizes W x H (mm)	Frame Width	Frame height 2030mm	Frame height 2081mm	Frame height 2089mm
		No sill - Open in or out Frame fitted with intumescent strip / smoke seal		
		Code	Code	Code
Hardwood				
762 x 1981 (2'6" x 6'6")	851mm	DF26FCA4		
813 x 2032 (2'8" x 6'8")	901mm		DF28FCA4	
838 x 1981 (2'9" x 6'6")	927mm	DF29FCA4		
Metric 726 x 2040	815mm			DF726FCA4
Metric 826 x 2040	915mm			DF826FCA4
Metric 926 x 2040	1015mm			DF926FCA4

FLAT PACK DOOR FRAMES

DOORS AND GARAGE DOORS

DOOR FRAMES

- Oak option to suit range of oak doors and windows
- Easily assembled on-site
- Oak frames supplied unfinished ready for painting or staining
- Weatherstripped
- 170mm sill

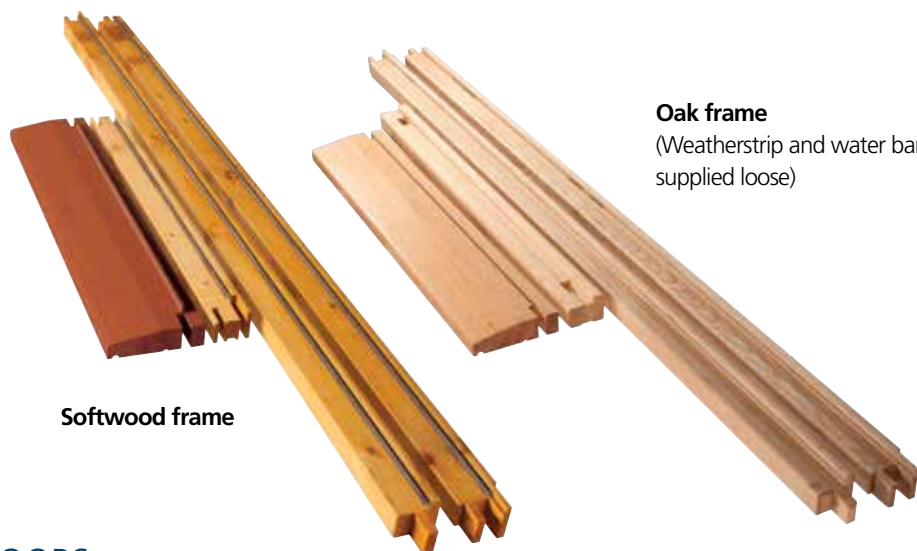

Softwood frame

Oak frame
(Weatherstrip and water bar supplied loose)

WEATHERSTRIPPED – DOORS

Door Sizes W x H (mm)	Frame Width	Frame Height 2076mm	Frame Height 2127mm	Frame Height 2086mm	Frame Height 2031mm	Frame Height 2082mm
		Inward/Outward Opening Reversible Sill	Inward/Outward Opening Reversible Sill	Inward Opening Mobility	Inward & Outward Opening No Sill	Inward & Outward Opening No Sill
		Code	Code	Code	Code	Code
Softwood						
838 X 1981 (2'9" x 6'6")	930mm	PFN29M		PFN29M-MOB	PF29	
813 X 2032 (2'8" x 6'8")	905mm		PFN28M			PF28
762 X 1981 (2'6" x 6'6")	854mm	PFN26M			PF26	
Oak						
914 X 1981 (3'0" x 6'6")	1006mm	PFN30MO		PFN30MO-MOB		
838 X 1981 (2'9" x 6'6")	930mm	PFN29MO		PFN29MO-MOB		
813 X 2032 (2'8" x 6'8")	905mm		PFN28MO			
762 X 1981 (2'6" x 6'6")	854mm	PFN26MO				

GARAGE DOOR FRAMES

When assembled the frames suit the door openings of the sizes shown.

They are intended for use with wood, GRP or steel retractable doors.

When using timber side-hung garage doors, a suitable stop will be required (not supplied).

Door Sizes Width x Height	Frame Width	Frame Height	Code
Softwood			
2134mm x 1981mm	2266mm	2047mm	UF7066NS
2134mm x 2134mm	2266mm	2200mm	UF7070NS
2286mm x 1981mm	2418mm	2047mm	UF7666NS
2286mm x 2134mm	2418mm	2200mm	UF7670NS
2438mm x 1981mm	2570mm	2047mm	UF8066NS
2438mm x 2134mm	2570mm	2200mm	UF8070NS
4267mm x 2134mm	4399mm	2200mm	UF14070NS



FINISHING EXTERIOR JOINERY

We recommend ordering factory painted or stained products to ensure they are finished correctly in order to protect and maintain their appearance for as long as possible.

It is important that timber products are finished correctly to prolong their life and keep them looking beautiful. We recommend buying fully finished painted or stained windows from us, giving you a great finish that protects and maintains their appearance for as long as possible and also saves in added decorating costs.

Your products will arrive ready to fit, requiring nothing more than a light clean with a soft sponge and soapy water to retain their condition for quite some time. We also guarantee our paint finishes for up to 10 years on a selection of colours.

Our Hi-Build paint and stains are microporous which allow moisture to be released whilst protecting the timber. Light colours carry a higher warranty than dark colours as they don't absorb the heat as quickly – **see the number in brackets to demonstrate the guarantee period on each colour.** Metallic and fluorescent colour options are not available.

If you do want to finish your own products, make sure you choose a good quality primer and Hi-Build paint or stain which is microporous to protect the timber whilst allowing it to breathe. You must finish your products before you expose them to the elements.

Standard paint options



Primed (Grey) for site finishing
Hi-Build White BS 00E 55 (10yr)

Hi-Build paint options

Subject to additional charges.



Hi-Build stain options

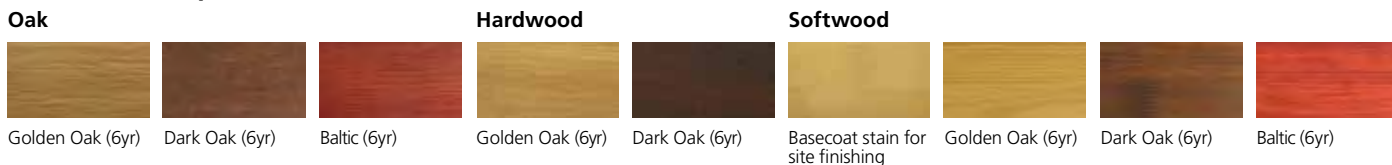

Castle composite doorsets colour options

Doorsets come in 7 exterior colours with a white interior finish. Golden oak and Rosewood not available on fire doors.

Through colours



Stained effect

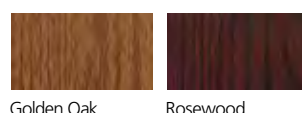

*Matching ventilators available at extra cost.

†Minimum order quantity will apply.

Finishing options shown are for guidance purposes only. There may be some variation to the finished product supplied.

Add a splash of colour...

If you want to add a touch of colour to the outside of a property you can choose from our standard colour palette, or alternatively you can pick any RAL colour you like!

We also offer dual colour finishing on all casement windows, INSULUX, DreamVu and Farndale exterior doorsets and Darwin, DreamVu and Farndale patio doorset ranges.

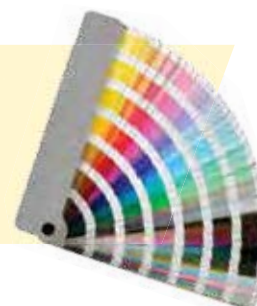

CHOOSING YOUR **HARDWARE**

STANDARD AND OPTIONAL

We are now offering a new improved window and doorset hardware specification which allows you to suite your JELD-WEN external joinery products.

Windows, external doorsets and UK manufactured patio doorsets – Canberra, Darwin, DreamVu™ and Farndale, offer the full suited colour options for you and your customers. Polished chrome is the standard colour option, other choices are satin chrome, gold, bronze, white and black with a special monkey tail option for our new Conservation Elegance Casement range.

HARDWARE SUPPLIED BY ERA

JELD-WEN's extensive range of UK manufactured casement windows, patio and exterior doorsets are supplied factory fitted with the ERA® range of suited quality hardware. All finishes salt spray tested to 480 hours (BS EN 1670: Class 5) coupled with a 10 year guarantee.

ERA® is at the technological forefront for the design, manufacture and distribution of hardware for the door and window industry. Recognised for its proven expertise in the development of innovative solutions; established and respected brands i.e. Vectis. ERA has been manufacturing and supplying quality security products for over 150 years

The package of window hardware includes suited hardware across casement, through to the traditional sliding sash applications; alongside high security shootbolt locking mechanisms and compatible friction hinges for security and egress applications.



Vectis Plus is ERA's new innovative security combination for doors; using traditional 5 lever mortice lock technology with modern cylinder-free multi-point locking; it introduces a new generation of door lock.

JELD-WEN's extensive range of UK manufactured patio doorsets are supplied factory fitted with the ERA® range of suited quality hardware.

All finishes salt spray tested to 480 hours (BS EN 1670: Class 5) coupled with a 10 year guarantee.

Vectis Plus is ERA's new innovative security combination for doors; using traditional 5 lever mortice lock technology with modern cylinder-free multi-point locking; it introduces a new generation of door lock.

The UK manufactured patio* doorset ranges are fitted with stylish door handles suited to match the window ranges.

* Excluding the Fenton range

www.era-security.com

Technical specification sheets

If you require further information, technical specification sheets can be downloaded from the JELD-WEN website for the following ERA® hardware products:

Doorsets

- **ERA Balmoral Inline Handle for Vectis plus Multi-Point Lock**
Canberra, Farndale, DreamVu™ and Castle composite
- **ERA 2D Adjustable Butt Door Hinge**
Canberra, Farndale, DreamVu™ and Castle composite
- **Vectis Plus 2 Hook Multi-Point Door Lock**
Canberra, Farndale and Castle composite
- **Vectis Fortress PAS 3621 Multi-Point Door Lock**
DreamVu™

Casement Windows

- **ERA Connoisseur Inline Locking Handle**
Elegance, Stormsure and Stormsure Energy+
- **ERA Monkey Tail Handle**
Elegance
- **ERA Monkey Tail Dummy Stay Bar**
Elegance



PATIO & EXTERIOR DOORSET HARDWARE

CANBERRA, DARWIN, FARNDALE, DREAMVU™ PATIO DOORSETS, INSULUX & CASTLE EXTERIOR DOORSETS



PATIO DOORSET HARDWARE

Hardware	Range	Item and Colour	Product Code
Handles	Canberra, Darwin, Farndale and DreamVu	Hardex Polished Chrome	35023
		Hardex Satin Chrome	35025
		Hardex Gold	35027
		Hardex Bronze	35026
		Hardex White	35024
		Hardex Black	35028
	Fenton	Locking Handle Left, Brushed Chrome	31709
		Locking Handle Right, Brushed Chrome	31708
Vents	Canberra and Darwin	White	15986
		Silver Grey	23124
		Green	32525
		Brown	15987
		External Canopy, White Aluminium	15984
		External Canopy, Grey Aluminium	26249
		External Canopy, Brown Plastic	22530
		External Canopy, White Plastic	22532
	External Canopy, Conservation Green Aluminium	32526	
	DreamVu and Farndale	External Canopy, White	15984
		External Canopy, Brown	15985
External Canopy, Silver Grey		26249	
Accessories	Fenton	Tandem Rollers	31721

FENTON

Brushed chrome locking handle
Left or right



Tandem rollers

EXTERIOR DOORSET HARDWARE

All our exterior doorsets come with polished chrome as standard but you can choose from any shown below.

Hardware	Range	Item and Colour	Product Code
Handles	INSULUX/Castle/DreamVu™/Farndale	Hardex Polished Chrome	35023
		Hardex Satin Chrome	35025
		Hardex Gold	35027
		Hardex Bronze	35026
		Hardex White	35024
		Hardex Black	35028
		Hardex Antique Black	35029
		Accessories	INSULUX/Castle
Letter Box, Satin Chrome	35033		
Letter Box, Gold	35035		
Letter Box, Black	35036		
Letter Box, White	35032		
Letter Box, Bronze	35034		
Letter Box, Antique Black	35037		
Security Chain, Gold	35055		
Security Chain, Silver	35056		
Polished Chrome Knocker	35038		
Chrome Viewer	35053		
Handles	DreamVu™/Farndale	External Canopy, White	15984
		External Canopy, Brown	15985
		External Canopy, Conservation Green	32526

ADDITIONAL HARDWARE

Viewer
Chrome, Gold



Security Chain
Chrome, Gold



Letter plates

Also available in Satin Chrome, Gold, Black, White, Bronze, Antique Black. Security Chain available in gold.



Urn Door Knocker

Polished chrome, Satin chrome, Gold, Bronze, White, Black, Antique black



For other hardware prices and options contact estimating on 0845 122 2892

WINDOW HARDWARE

ELEGANCE, STORMSURE ENERGY+, STORMSURE AND REGENCY CASEMENT

Polished chrome (standard), satin chrome, gold, bronze, white, black, antique black



Hardex polished chrome (Standard)



Hardex satin chrome



Hardex gold



Hardex bronze



Hardex white



Hardex black



Hardex antique black



Hardex antique black monkey tail handle (Casement range only)



Hardex antique black monkey tail mock stay (Casement range only)

SLIDING SASH

Brushed chrome (standard), gold, white



Brushed chrome lock and keep



Brushed chrome sash lift



Deluxe tension key

REGAL BOX SASH

Gold (standard), chrome



Gold fitch catch



Gold sash lift



Gold ring pull

ADDITIONAL WINDOW HARDWARE



Projecting hinge



Reflex fire egress projecting hinge



Restrictor



Lockable cord restrictor

HARDWARE SUPPLIED BY **ERA** www.era-security.com

JELD-WEN's extensive range of UK manufactured windows are supplied factory fitted with the ERA® range of suited quality hardware to match the external and patio doorset ranges.

All finishes salt spray tested to 480 hours (BS EN 1670: Class 5) coupled with a 10 year manufacturing guarantee.

www.era-security.com

Hardware	Window Range	Item and Colour	Product Code
Handles	Stormsure & Elegance	Hardex Polished Chrome	34899
		Hardex Satin Chrome	34901
		Hardex Gold	34903
		Hardex Bronze	34902
		Hardex White	34900
		Hardex Black	34904
		Hardex Antique Black	34905
		Hardex Antique Black Monkey Tail Left (Elegance only)	34969
		Hardex Antique Black Monkey Tail Right (Elegance only)	34968
	Sliding Sash (non SBD only)	Hardex Black Sash Lift	34941
		Hardex Bronze Sash Lift	34940
		Hardex Gold Sash Lift	34939
		Hardex Polished Chrome, Sash Lift	34937
		Hardex Satin Chrome Sash Lift	34938
		Hardex White Sash Lift	34936
		Hardex Antique Black, Sash Lift	34942
		Hardex Black Locking Fitch Fastener & Keep	34933
		Hardex Bronze Locking Fitch Fastener & Keep	34931
		Hardex Gold Locking Fitch Fastener & Keep	34932
		Hardex Polished Chrome Locking Fitch Fastener & Keep	34928
		Hardex Satin Chrome Locking Fitch Fastener & Keep	34930
		Hardex White Locking Fitch Fastener & Keep	34929
		Hardex Antique Black Locking Fitch Fastener & Keep	34934
Regal Box Sash	Gold Fitch Catch	36747	
	Chrome Fitch Catch	36748	
Restrictor	Stormsure & Elegance	Restrictor Right Hand (inc Peg and Packer)	15115/20223
		Restrictor Left Hand (inc Peg and Packer)	15116/20223
		Lockable Cord Restrictor, White	30878
		Lockable Cord Restrictor, Brass	30877
		Lockable Cord Restrictor, Polished Chrome	30876
	Sliding Sash	White Restrictor	16065
	Regal Box Sash	Gold Restrictor	36748
Chrome Restrictor		36746	
Hinges	Stormsure & Elegance	Crusader Projecting Hinge Pair Side Hung 12"	34949
		Crusader Projecting Hinge Pair Side Hung 16"	34950
		Crusader Projecting Hinge Pair Top Hung 8"	34943
		Crusader Projecting Hinge Pair Top Hung 10"	34944
		Crusader Projecting Hinge Pair Top Hung 12"	34945
		Crusader Projecting Hinge Pair Top Hung 16"	34946
		Crusader Projecting Hinge Pair Top Hung 20"	34947
		Crusader Projecting Hinge Pair Top Hung 24"	34948
		Reflex Projecting Hinge Pair Fire Egress Side Hung 12"	34951
		Reflex Projecting Hinge Pair Fire Egress Side Hung 16"	34952
Vents	Stormsure	White	15986
		Brown	15987
		Silver Grey	23124
		Conservation Green	32525
	Sliding Sash	Brown	17262
		White	17261
Accessories	Elegance Casement	Hardex Antique Black Monkey Tail Mock Stay	34969
	Sliding Sash	Deluxe Tension Key	22476
	Regal Box Sash	Ring Pull, Gold	36727
		Ring Pull, Chrome	36725
		Sash Lift, Gold	36722
		Sash Lift, Chrome	36718
		D Handle, Gold	36736
		D Handle, Chrome	36732

For other hardware prices and options contact estimating on **0845 122 2892**

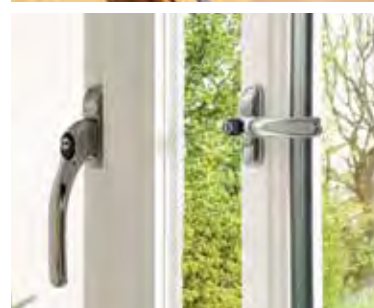



COMMITMENTS AND GUARANTEES

We offer the following guarantees on products. These will become void when surface finishes or faults are caused by wilful or neglectful damage or by excessive wear and tear. Shattering glass due to the thermal stress and other non product related issues are not covered under these guarantees. All relevant guarantees have been added to individual product pages.

WINDOWS AND DOOR FRAMES

- 

40 year guarantee against rot and fungal attack on all softwood timber components.
- 

30 year guarantee against rot and fungal attack on all oak and hardwood timber components.
- 

10 years guarantee against manufacturing defects. JELD-WEN will accept no responsibility for products cut down to size after receipt, or which use or structural strength is impaired following improper fitting of windows or hardware.
- 

10 years guarantee against double or triple glazed unit failure on factory glazed windows.

PATIO DOORSETS

- 

40 years guarantee against rot and fungal attack on softwood patios – Fenton, DreamVu™ and Farndale.
- 

30 years guarantee against rot and fungal attack on hardwood and solid oak patios – Canberra, and Darwin ranges.
- 

10 years guarantee against manufacturing defects, hardware and glazing – Canberra, Darwin, Fenton, DreamVu™ and Farndale. JELD-WEN will accept no responsibility for products cut down to size after receipt, or which use or structural strength is impaired following improper fitting of doors or hardware.

EXTERIOR AND DOORSETS

- 

10 years guarantee against manufacturing defects. JELD-WEN will accept no responsibility for products cut down to size after receipt, or which use or structural strength is impaired following improper fitting of doors or hardware.
- 

10 years guarantee against double or triple glazed unit failure on factory glazed exterior doors and doorsets.

PAINT AND STAIN

For details of guarantees on our standard colour palette please see page 152. All our factory finishes are guaranteed in accordance with EN927.

- 

6 years guarantee on factory finished Hi-Build dark painted colours, under normal exposure.
- 

8 years guarantee on factory finished Hi-Build Cream White, Light Ivory and Pastel Green under normal exposure.
- 

10 years guarantee on factory finished Hi-Build White Gardenia and Buttermilk colours under normal exposure.
- 

6 years guarantee on factory finished Hi-Build stained products under normal exposure.

Suggested redecoration cycles:

For pigmented coating system (e.g. white or pastel colours) applied on timber windows:

Construction	Moderate climate	Hard climate	Extreme climate
Sheltered	10 Years	10 Years	7 Years
Partly sheltered	10 Years	7 Years	5 Years
Unsheltered	7 Years	5 Years	5 Years

For stain and lacquer coating system applied on timber windows:

Construction	Moderate climate	Hard climate	Extreme climate
Sheltered	6 Years	5 Years	3 Years
Partly sheltered	5 Years	3 Years	2 Years*
Unsheltered	3 Years	2 Years*	2 Years*

*Only dark stain allowed.

Golden oak stain 2 years maximum.

Moderate climate: includes non coastal areas at low altitude

Hard climate: includes an area within 5km of coastline

Extreme climate: any area of high altitude or exposed coastal areas

This guide is based on EN927



GENERAL MAINTENANCE GUIDELINES

The decoration and finishing of joinery products is covered in BS6150: 2006 'Painting in buildings' and BS8000 Part 12: 1989.

The decorative finish applied to windows, external doors and patio doorsets must be preserved while they are in service to ensure moisture does not penetrate the wood.

JELD-WEN products should be maintained in accordance with the guarantees or the paint or stain manufacturer's guidelines, to prevent the finish from deteriorating and to protect the timber underneath. See the finishing section for advice on paint and stain recommendations.

We recommend the following to maintain and extend the life of your exterior joinery products:

- All joinery should be washed down a minimum of twice a year with a mild solution of soapy water and rinsed off with clean water to remove any surface debris. This should be increased to four times a year in marine and industrial environments.
- All mechanical hinges etc such be oiled with grease or neutral oil.
- Weather seals should be checked and cleaned.
- Vents should be cleaned and any blockages removed.
- Once cleaned, scrape, lightly sand and touch up any areas of wear and tear with a matching microporous paint or stain. Any bare wood should be primed first.
- Timber is a natural product and therefore performs differently through the year, seasonal adjustment may be required to assure ongoing performance.

Do not attempt to paint when temperatures fall below 8°C or if the humidity is above 85% or in direct sunlight as this will impair the curing process.

Interior products should be kept clean and new coats reapplied as necessary of good quality paint, stain, varnish or lacquer. You may need to sand and apply undercoat again first depending on the condition or choice of finish.

Hardware

Hinges, pivots, rivets and other moving parts must never be painted and should be kept clean and lubricated lightly at all times with grease or neutral oil.

Products should be cleaned and lubricated at least once a year - more often in coastal areas and places where pollution is high.

Guarantees will reduce depending on location even if general maintenance advice is undertaken.

JELD-WEN external hardware is tested to BS EN1670:2006 for corrosion resistance and generally achieves 480 hours. Areas such as coastal or industrial may require higher performance. This should be specified at time of order/enquiry. The test exposure time above relates to the amount of time that a component part has been exposed to a neutral salt spray under laboratory conditions. There is no direct correlation between a given number of hours salt spray testing and real time natural environment exposure. If handles are not cleaned the resistance is impaired.

For accessible cleaning options to the glass on your side hung windows opt for the Reflex Plus projecting hinge in compliance with BS 8213-1:2004. Projecting hinges should not be used on top hung windows as this would contravene BS 8213-1:2004 Annex C and Scottish Building Regulations.



BOVIS HOMES

Traditional beauty in the Cotswolds

When Bovis Homes was looking to build a new housing development at a WWII air field in the Cotswolds, they needed a specialist manufacturer that could supply and fit a high volume of timber windows, French patio doorsets and staircases that met strict design specifications and offered modern functionality.

The Victory Fields development is located in Upper Rissington in Gloucestershire and the project will see JELD-WEN support the development of 182 three to five bedroom homes over four years. Due to the location and heritage of the site, the Gloucestershire planning authorities were very strict in their requirements for the project to ensure the homes remained sympathetic to their surroundings and in-keeping with other properties in the area.

All windows and external doorsets had to be timber, with a flush sash and finished in BS12B17 opaline green. Flush style windows have been popular in the past, but went out of fashion in the 1960s as more homeowners demanded storm-proof windows – previously, flush sash windows did not offer the same functionalities as modern style windows. However, JELD-WEN has recently developed a conservation flush sash window ‘Elegance’ that achieves modern standards and boasts a traditional look. To meet the demands and timescale of the project, JELD-WEN brought the launch of its new Elegance range forward by six months.

In addition to a traditional appearance, Bovis Homes and the planning authorities required windows that would withstand adverse weather, offer excellent thermal efficiency and provide enhanced security for homeowners. The newly launched Elegance range met Approved Document E noise level standards and Approved Document L thermal efficiency standards with a U value of 1.4.

Victory Fields fact sheet

Project:	Development of 182 three to five bedroom houses
Architect:	Bovis Homes
Location:	Cotswolds, Gloucestershire
Contractor:	Bovis Homes
Products	<ul style="list-style-type: none"> • Elegance conservation windows • Farndale French doors • Stairs

At least two windows on the first floor of every property were fitted with bespoke ironmongery that met fire egress requirements and the window casements were also fitted with multi-point espagnolette locking systems and laminated glass to meet Secured by Design criteria.

In addition to casement windows, Bovis Homes also specified at least one set of Farndale patio doors for every property. The softwood timber doorsets were finished in the same opaline green colour as the Elegance windows and met strict security and thermal efficiency criteria.

JELD-WEN also supplied stop chamfered three coat white primed staircases and upgraded the components for the Victory Fields development, including oak traditional style handrails and square caps.

‘Gloucestershire planning authorities were very strict in their requirements for the project to ensure the homes remained sympathetic to their surroundings and in-keeping with other properties in the area.’

For project support email us at projectsuk@jeldwen.com, for more case studies visit the website.



AFTER



BEFORE

PEROWNES FARM

Rising from the ashes

A 16th Century farmhouse in rural Norfolk has been brought back to life, following the devastating effects of a fire two years ago.

The idyllic thatched roof property, home to the Rogerson family for eight years, was devastated by a fire in 2012. Adamant that they would not leave this picturesque setting, which housed two acres of garden, they decided to re-build their home and, following a visit to Buildbase, were recommended JELD-WEN to supply their joinery products.

The farmhouse took three weeks to take down, following which it was rebuilt using oak and original materials, including beams and bricks from the chimney that complemented six bedrooms, and bathrooms and five reception rooms.

The project was managed by D Moore Builders who enlisted JELD-WEN's expertise to source window sizes for all 33 oak Stormsure windows that were used throughout the property.

The family also opted for Canberra folding sliding patio doors, which gives a contemporary option that also eliminates the worry of doors bumping against walls or furniture. The bespoke Chamfered oak staircase from JELD-WEN's prestigious range was a great addition, as it immediately creates an impressive grand entrance.

Simon Barron Sales Representative at JELD-WEN, said: "Despite the unfortunate circumstances in which the family came to use

For project support email us at projectsuk@jeldwen.com, for more case studies visit the website.

Perownes Farm fact sheet	
Project:	16th century farmhouse rebuild after fire
Location:	Blofield, Norfolk
Contractor:	Darrin Moore Builders
Products	<ul style="list-style-type: none"> • Canberra Folding Sliding Patio Doors • Oak Stormsure Windows • Oakfold Patio Doors • Chamfered Standard Staircase

JELD-WEN products, this was a fantastic project to be a part of. We knew how much this rebuild meant to the family so we made sure they had all the necessary information to choose the products that best suited them. We also supported the builders to ensure that they had both the knowledge and information required to handle and fit JELD-WEN products, particularly as oak is extremely heavy to work with."

The Rogerson family, said: "JELD-WEN was fantastic throughout this entire project. Not only did they provide a very good service, but the quality of its products was exceptional. This was a very emotional project for all of the family, but JELD-WEN's support helped everything run so smoothly. Two years after the fire, it's great to feel so settled again in such a beautiful home."

'JELD-WEN was fantastic throughout this entire project. Not only did they provide a very good service, but the quality of its products was exceptional.'



MOUNT WISE DEVELOPMENTS

Georgian splendour by the sea

Covering 28 acres and boasting its own hotel, convenience store and cricket pavilion, the exceptional Mount Wise development on the outskirts of Plymouth blends beautiful Georgian-inspired architecture with the benefits of modern living.

Following 200 years under Ministry of Defence ownership, Mount Wise has now been transformed into 469 luxury houses and apartments with spectacular views across Royal William Yard and Plymouth Sound.

At the heart of this project is the grade II listed Admiralty House, which has been converted sympathetically into a boutique hotel. To complement its majestic Georgian facades, main contractor, the Leadbitter Group, enlisted the help of JELD-WEN to provide timber windows and doors for the new build homes that not only reflected the site's heritage, but also offered first class thermal performance.

Vertical Sliding Sash windows and Clifton double patio doorsets were specified for all of the 119 homes in phase one. All of the windows and doorsets supplied were supplied fully finished in white and bespoke design, demonstrating JELD-WEN's technical and production capabilities, whilst enhancing the project's green credentials and helping residents save on their energy bills.

For project support email us at projectsuk@jeldwen.com, for more case studies visit the website.

Mount Wise Developments fact sheet

Project:	New apartments and houses at Mount Wise
Architect:	The Architects Design Group
Location:	Plymouth, Devon
Contractor:	Bouygues UK
Products	<ul style="list-style-type: none"> • Vertical sliding sash windows • Internal ReadyFit® doorsets • Double doorsets

The affordable homes within the scheme required windows to meet the Police-backed Secured by Design standards. JELD-WEN is one of the only manufacturers to produce vertical sliding sashes that meet these stringent standards and our high performance windows achieved a U Value of 1.4 W/m²K, in line with the latest Approved Document L requirements. In addition, these windows are also extremely easy to maintain due to their innovative easy clean mechanism, which enables the glass to be cleaned from the inside.

All of the windows and doorsets supplied were bespoke, demonstrating JELD-WEN's technical and production capabilities.



“We specified JELD-WEN products as we were aware of their bespoke capabilities, especially in producing sliding sash windows in a conservation style.”

SHROPSHIRE HOMES

Apartments breathe new life into hospital

When Shropshire Homes converted a former hospital into stylish apartments, it called on JELD-WEN to supply windows that would enhance the Victorian building’s historic appearance.

The sympathetic renovation of Wordsley Hospital in Stourbridge was a major development, transforming its imposing red brick structure with a landmark clock tower, which was built as a workhouse in 1903 and became a hospital after the First World War. It is now a collection of 83 one and two bedroom apartments, housed in the original structure and additional new build blocks.

The housebuilder specified JELD-WEN’s double glazed vertical sliding sash windows on all levels of both the renovation and the new build for Block 2. They were supplied to bespoke dimensions with a conservation fret to enhance the building’s historic appearance, and a unique 100mm bottom rail on each lower sash to replicate the original fittings.

There was also an acoustic requirement to achieve a decibel reduction of 43 dB. This was achieved in conjunction with secondary glazing and our vertical sliding sash.

In addition to offering stunning aesthetics and meeting Approved Document L requirements, these windows are also easy to clean due to

For project support email us at projectsuk@jeldwen.com, for more case studies visit the website.

www.jeld-wen.co.uk

Shropshire Homes fact sheet

Project:	New apartments at Wordsley Hospital
Architect:	Shropshire Homes
Location:	Stourbridge, Worcestershire
Contractor:	Shropshire Homes
Products	• Sliding Sash windows

their innovative tilt and turn functionality, which means the glass can be cleaned from the inside.

For the clock tower roof, our Stormsure casement windows were fitted into GRP pre-formed dormers to provide first class thermal performance and enhance the external look of the development.

All of the windows were factory finished in Gardenia, a cream colour, to further enhance their performance and longevity.

Ian Norris, Shropshire Homes’ senior buyer, said: “We specified JELD-WEN products as we were aware of their bespoke capabilities, especially in producing sliding sash windows in a conservation style. It was so important on this project that the windows had an authentic appearance, yet could meet modern thermal performance requirements. We had worked with JELD-WEN before and were confident in the quality and reliability of their manufacturing process. The result is a stunning development that retains the aesthetics of this striking building, creating appealing apartments that are already gaining lots of interest”.



THE QUEEN'S HEAD

A new lease of life for the Queen's Head pub

JELD-WEN was chosen as the number one external joinery supplier for the Queen's Head renovation project in Hempsall, Norfolk, supplying various windows and patio doorsets for the property.

The property although not a listed building was situated in a local conservation area and so the homeowner was looking for windows that fitted specific requirements and complemented other properties in the area. The homeowner had previously specified JELD-WEN products for other projects and looked to JELD-WEN to supply the windows and patio doorsets for the property.

JELD-WEN's Elegance conservation casement window fitted the requirements for the property perfectly and over twenty made to measure windows in conservation green and with special monkey tail handles were supplied. JELD-WEN also supplied timber Farndale French patio doorsets and single doorsets in conservation green to match the windows.

The renovation project was extremely challenging due its age and general condition and resulted in some sections of the building needing to be completely demolished and others rebuilt. This also threw up various issues when it came to installing the windows; the old window lintels were supporting sections of the walls, the back wall of the property was bowed, and the walls were not straight due to settlement.

For project support email us at projectsuk@jeldwen.com, for more case studies visit the website.



The Queen's Head fact sheet

Project:	The Queen's Head
Client:	Homeowner – Paul Ellis
Architect:	David Futter Associates, Norwich
Location:	Cotswolds, Gloucestershire
Contractor:	J Ireson Builders, Swainsthorpe
Products	<ul style="list-style-type: none"> • Elegance conservation windows • Farndale French patio doorsets • Farndale single doorsets

JELD-WEN worked closely with the homeowner to overcome any issues and ensure the window and doorset installation went as smoothly as possible.

Paul Ellis, Homeowner commented,

'We are extremely pleased with the Elegance windows and Farndale doorsets supplied by JELD-WEN. Since the renovation has been completed we have received many compliments about the windows and particularly the monkey tail handles which have added to the overall finish.'

'During the project the JELD-WEN team worked hard to overcome the difficult challenges that the old property presented, and I cannot fault the service they gave to us. I will definitely consider JELD-WEN products for projects in the future.'

CONTACT US

To send us your enquiry you can contact us as follows:

General Enquiries: **0845 122 2892**

Window & Patio Estimating: **0845 122 2892**

Email: **windowsuk@jeldwen.com**

JELD-WEN UK LTD

Snow Hill

Melton Mowbray

Leicester

LE13 1PD

www.jeld-wen.co.uk